



SURGICAL INSTRUMENT



We thrive to innovate and invent something fresh for the healthcare industry that nobody has seen before. Steered by a strong desire to provide our customers utmost standard...



PAGE OF CONTENTS

1. HOME	03
2. GENERAL SURGERY	04
3. OBSTETRICAL & GYNECOLOGY	99
4. UROLOGY / INTESTINAL	139
5. GALL BLADDER / RECTAL	165
6. NEURO SURGERY	169
7. CARDIOVASCULAR / THORACIC INST.	221
8. ORTHOPEDIC INSTRUMENTS	227
9. ENT INSTRUMENTS	317
10. TITANIUM INSTRUMENTS	350
11. INSTRUMENTS CONTAINER	362
12. TABLE MOUNTED RETRACTOR SETS	363



Benefiting from healthcare shouldn't be a matter of luck!

RAZZO was founded in 2009 with a clear objective that remains to this day, to fuse contemporary design, time tested craftsmanship & technical innovation and supply healthcare that both looks and feels great. We thrive on consummating performance in quality something that the new-age customers quest for.

OUR QUALITY

With over a Decade of experience, we are aware of your sartorial sensibilities and aspire to satiate the same with our healthcare solutions, culminating in the best of both quality and function, hence we adhere to top-notch quality and a discerning eye for detail. With each passing year, we thrive to innovate and invent something fresh for the healthcare industry that nobody has seen before. Steered by a strong desire to provide our customers utmost standard.

WHY RAZZO?

We are in manufacturing and trading high-quality surgical instruments, laparoscopic hand instruments, Hospital Furniture, Operation Theatre Lights & Tables etc. With ISO CE GMP & FDA Registration, we bestow a piece of world-class equipment to every city and country. We will provide complete, comprehensive, and affordable solutions in the surgical and critical care verticals to the global healthcare industry.

Razzo Health Care aims to put technology within your reach, by producing surgical and critical care equipment with the highest quality, most up-to-date technology, customized solutions, and first rate service and support. Our management team is very capable and constantly works to make our company the healthcare professionals prefer.

In addition to operating tables, surgical lights, stirrups, gasless laparoscopic positioners, anaesthesia workstations, and many other topics, we have expanded on his original research ideas. We have more experience analysing the problems users encounter and are able to offer our clients specialised solutions. We only use premium raw materials to create high-quality products, enabling us to achieve complete customer satisfaction.



SCALPELS & KNIVES

SCALPEL HANDLES

DISSECTING KNIVES



RHC 04.03
No. 03



RHC 05.07
No. 07



RHC 06.17
No. 7



RHC 04.13
No. 3L



RHC 09.04
No. 4



RHC 10.64
No. 4L



1/1
160mm/6 1/4"



RHC 12.41
Fig.1



RHC 12.42
Fig.2



RHC 12.43
Fig.3



RHC 12.44
Fig.4



RHC 12.45
Fig.5



RHC 12.46
Fig.6



RHC 12.47
Fig.7



RHC 12.48
Fig.8



RHC 12.49
Fig.9



RHC 12.50
Fig.10

AMPUTATING & BRAIN KNIVES



LISTON



LANGENBECK

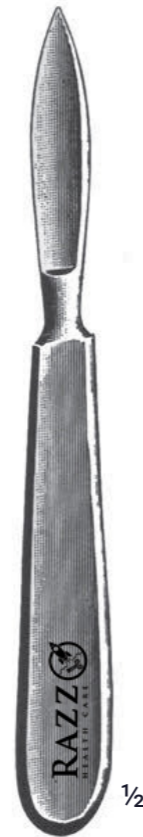

RAE 19.02



VIRCHOW

	RAE 17.20	RAE 19.01	RAE 19.02
Total length	290mm/11 1/2"	180mm/7"	180mm/7"
Cutting length	190mm/7 1/2"	55mm/2 1/4"	55mm/2 1/4"

RAE 25.16 -160mm/6 1/4"
 RAE 25.18 -200mm/8"
 RAE 25.24 -240mm/9 1/2"



DRESSING & TISSUE FORCEPS

DISSECTING FORCEPS

TISSUE FORCEPS

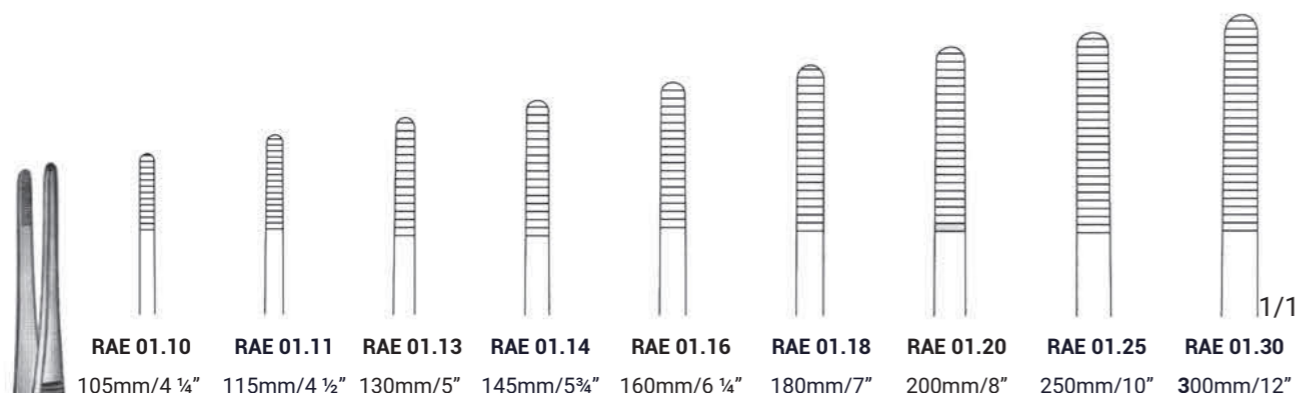

STANDARD

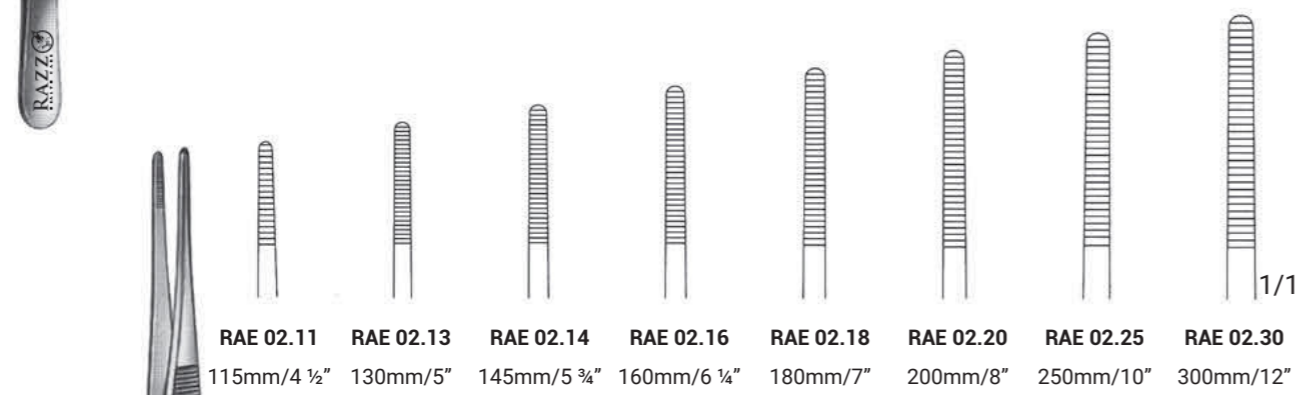

STANDARD
Narrow

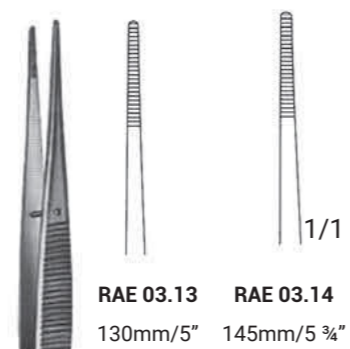

STANDARD
Delicate

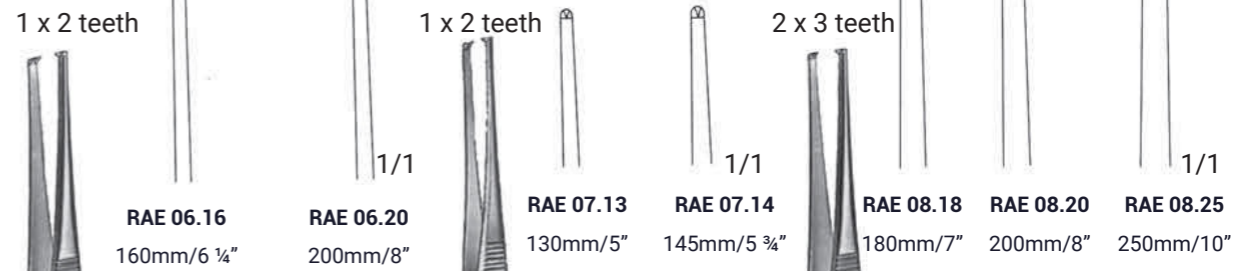
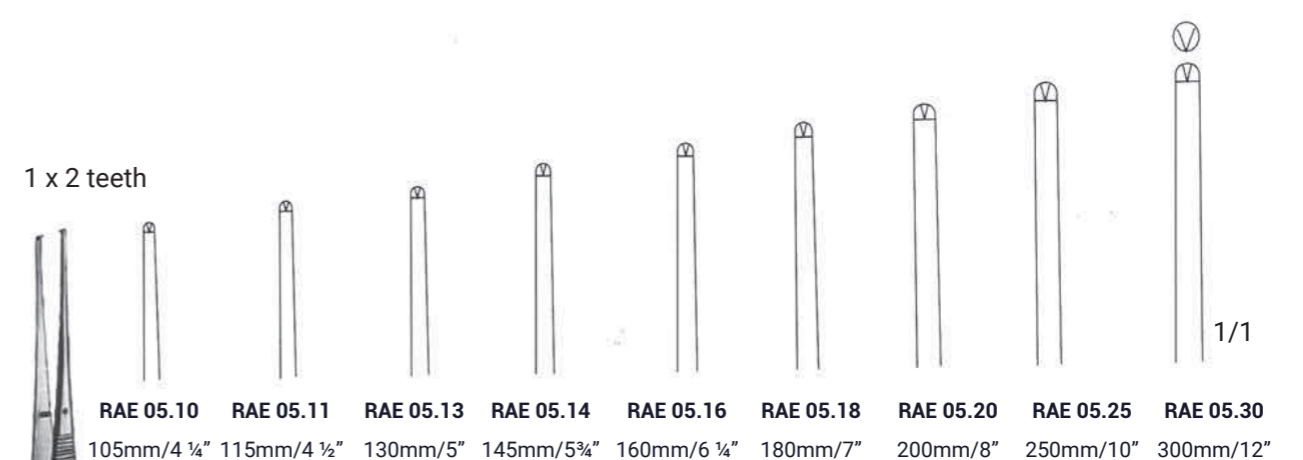

MEDIUM

DELICATE

DELICATE

TISSUE FORCEPS

ADSON FORCEPS WITH T/C

3 x 4 teeth

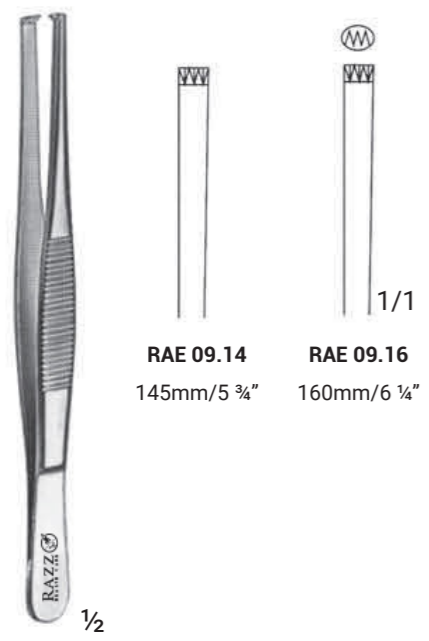

4 x 5 teeth

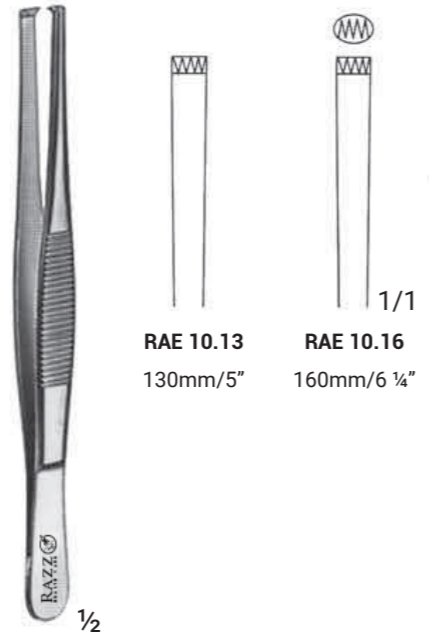

5 x 6 teeth

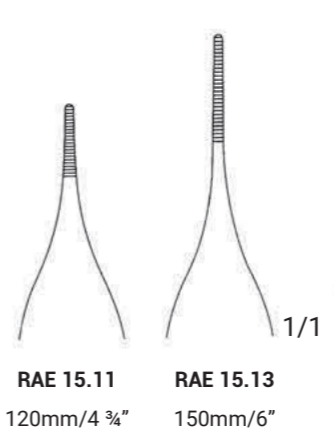
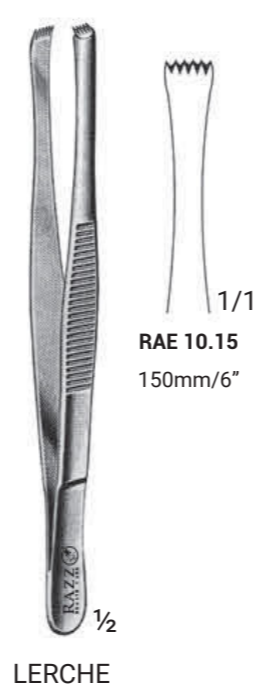

5 x 6 teeth



2 x 3 teeth

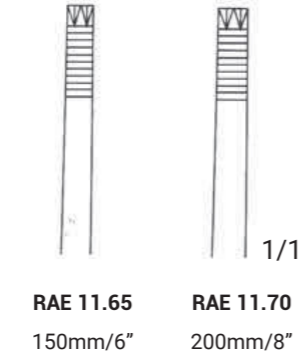

2 x 3 teeth

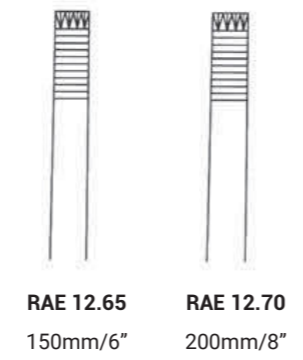

4 x 5 teeth

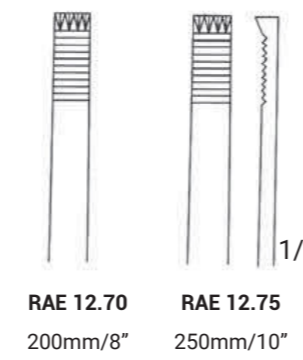

4 x 5 teeth

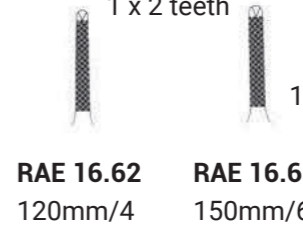
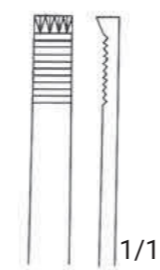

1 x 2 teeth

MICRO TISSUE FORCEPS WITH T/C

DELICATE TISSUE FORCEPS WITH T/C

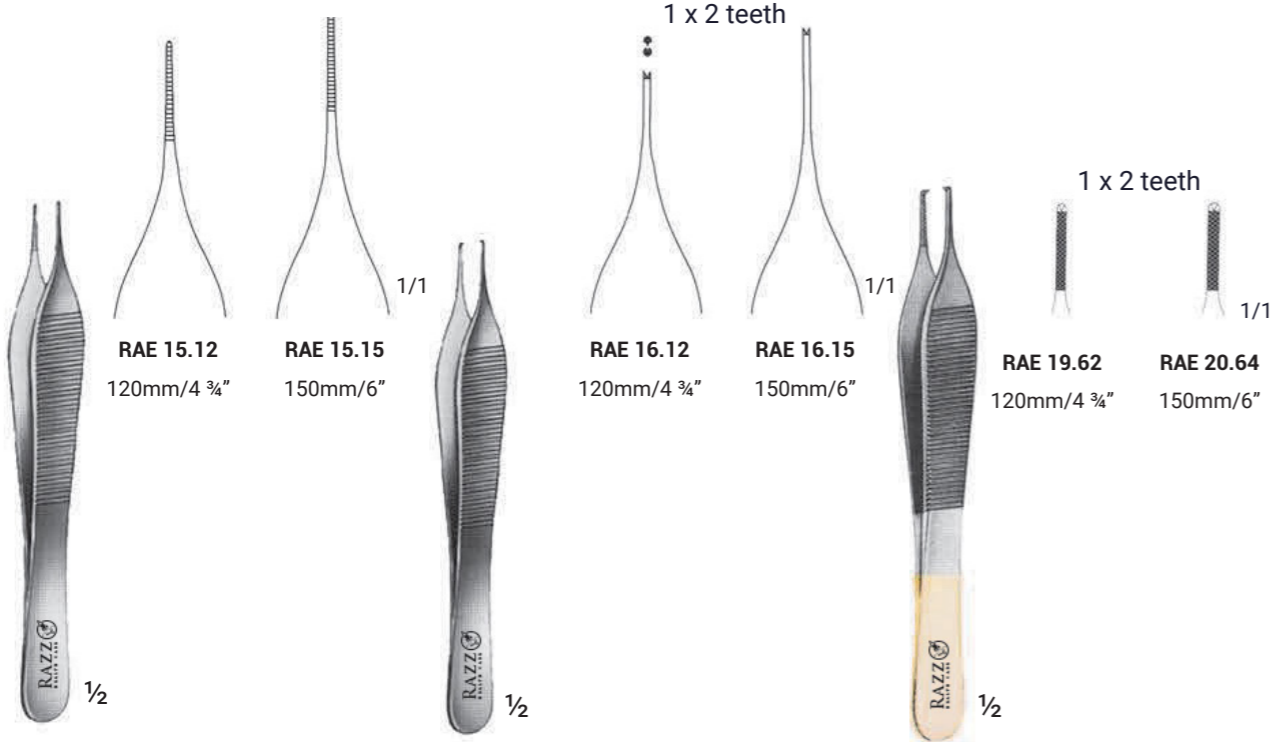

MICRO ADSON

MICRO ADSON

MICRO ADSON T/C

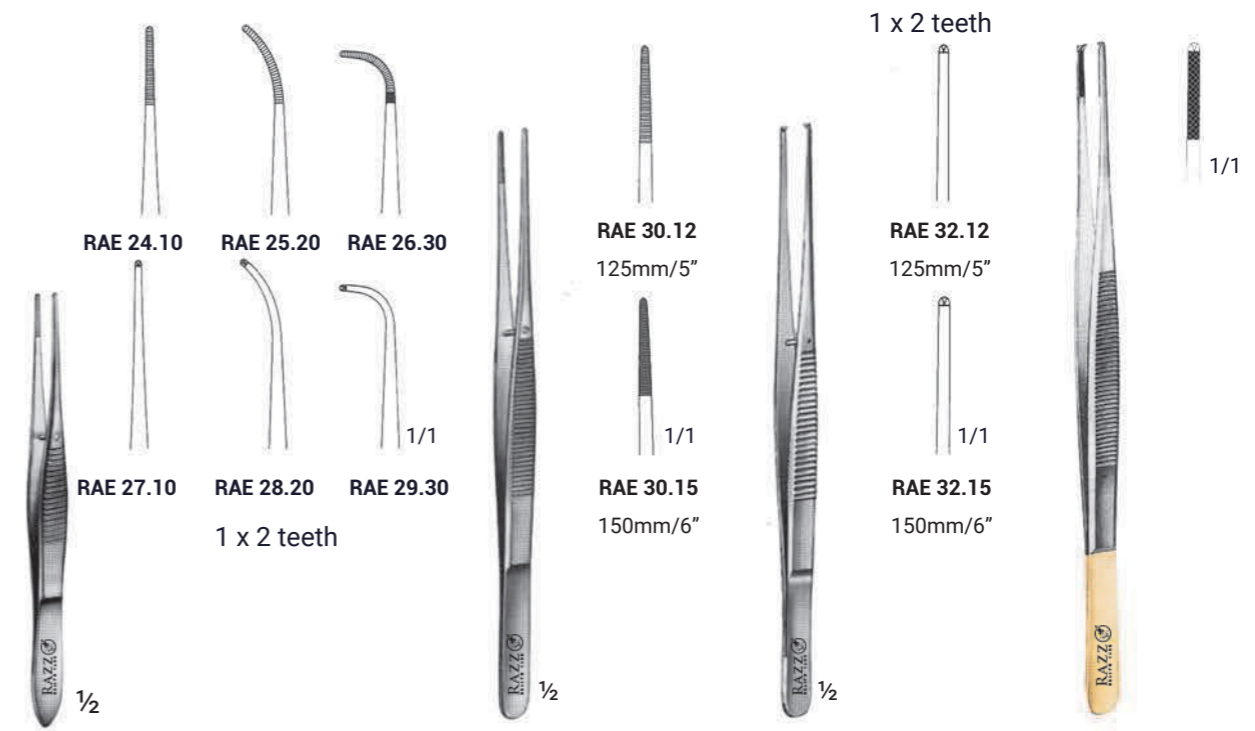

IRIS
100mm/4"

SEMKEN

SEMKEN

SEMKEN T/C

RAE 32.66 - 160mm/6 1/4"
RAE 32.68 - 180mm/7"



MICRO BROWN
120mm/4 3/4"

MICRO BROWN
T/C 120mm/4 3/4"

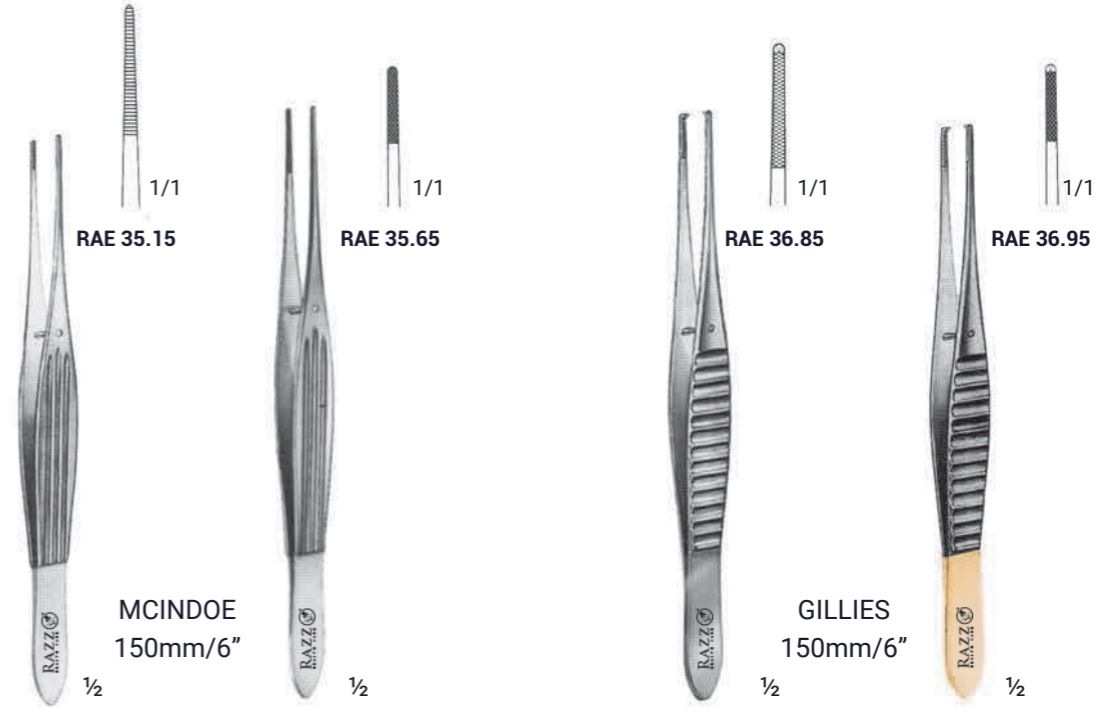

MCINDOE
150mm/6"

GILLIES
150mm/6"

T/C

T/C

TISSUE FORCEPS WITH T/C

ATRAUMATIC VASCULAR FORCEPS

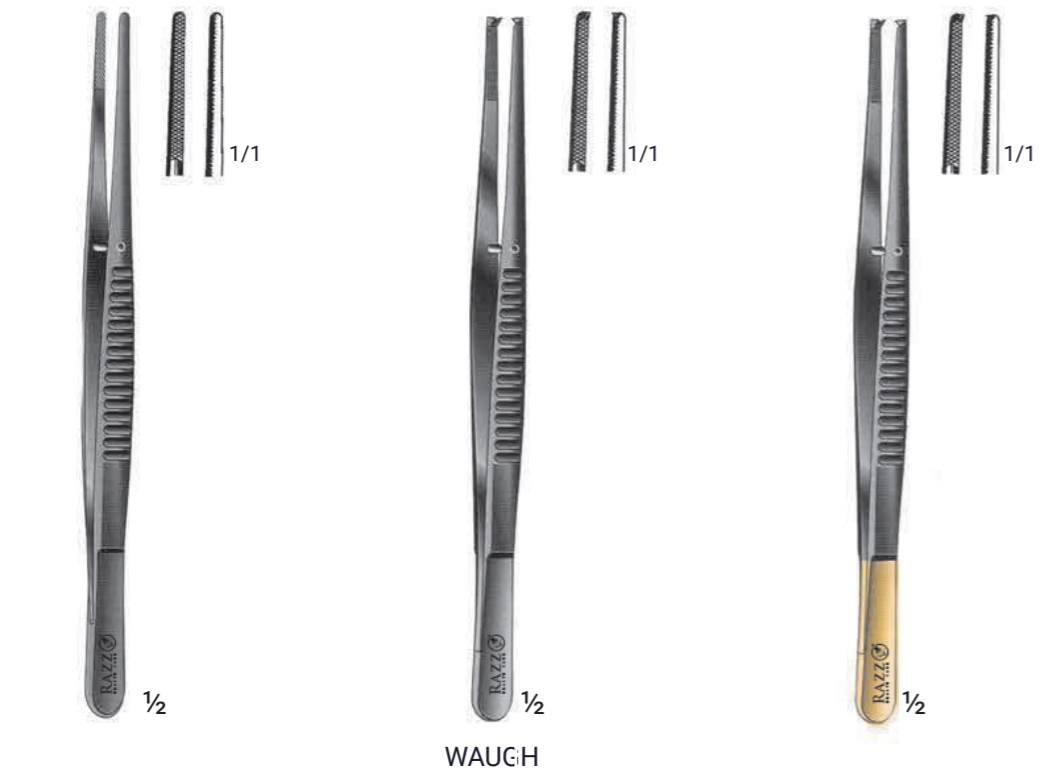

	1 x 2 teeth		T/C
150mm/6"	RAE 37.15	RAE 38.15	RAE 38.65
200mm/8"	RAE 37.20	RAE 38.20	RAE 38.70

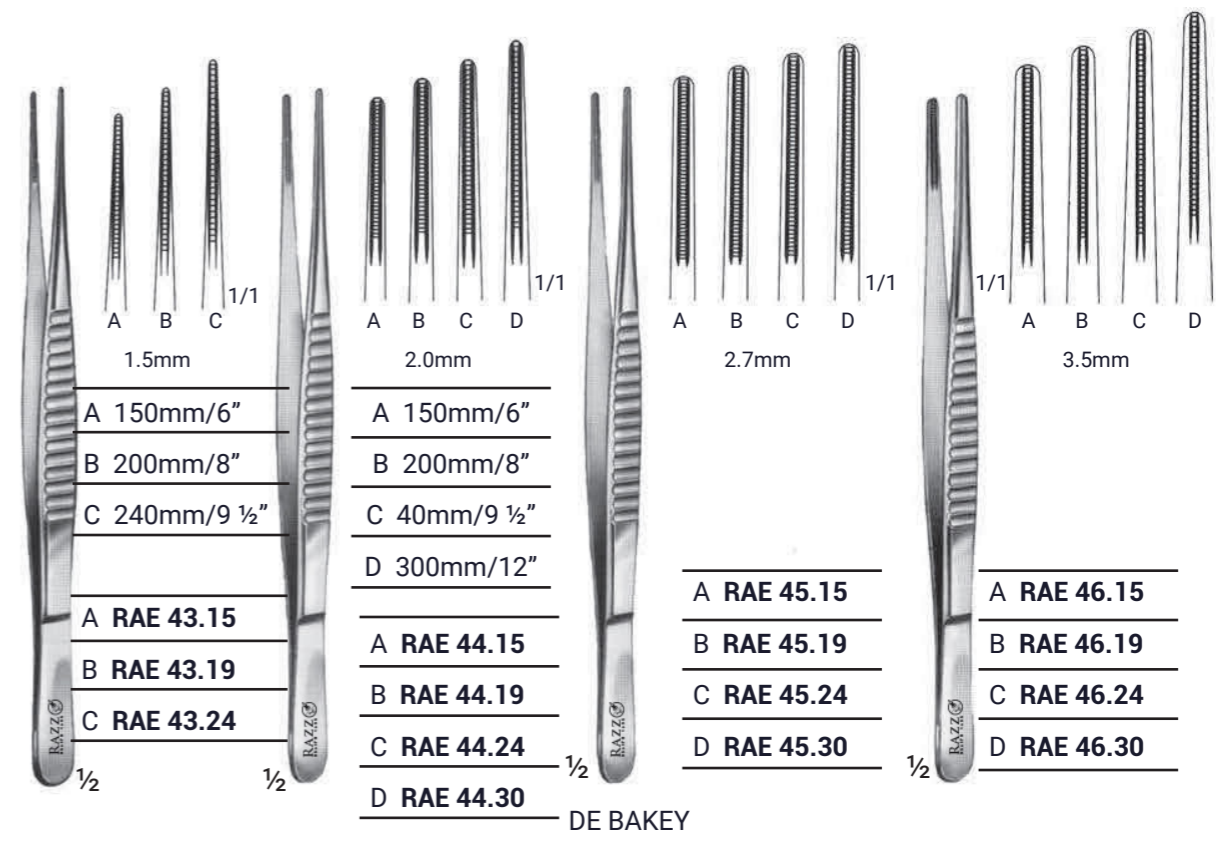

1.5mm	2.0mm	2.7mm	3.5mm
A 150mm/6"	A 150mm/6"	A RAE 45.15	A RAE 46.15
B 200mm/8"	B 200mm/8"	B RAE 45.19	B RAE 46.19
C 240mm/9 1/2"	C 40mm/9 1/2"	C RAE 45.24	C RAE 46.24
	D 300mm/12"	D RAE 45.30	D RAE 46.30

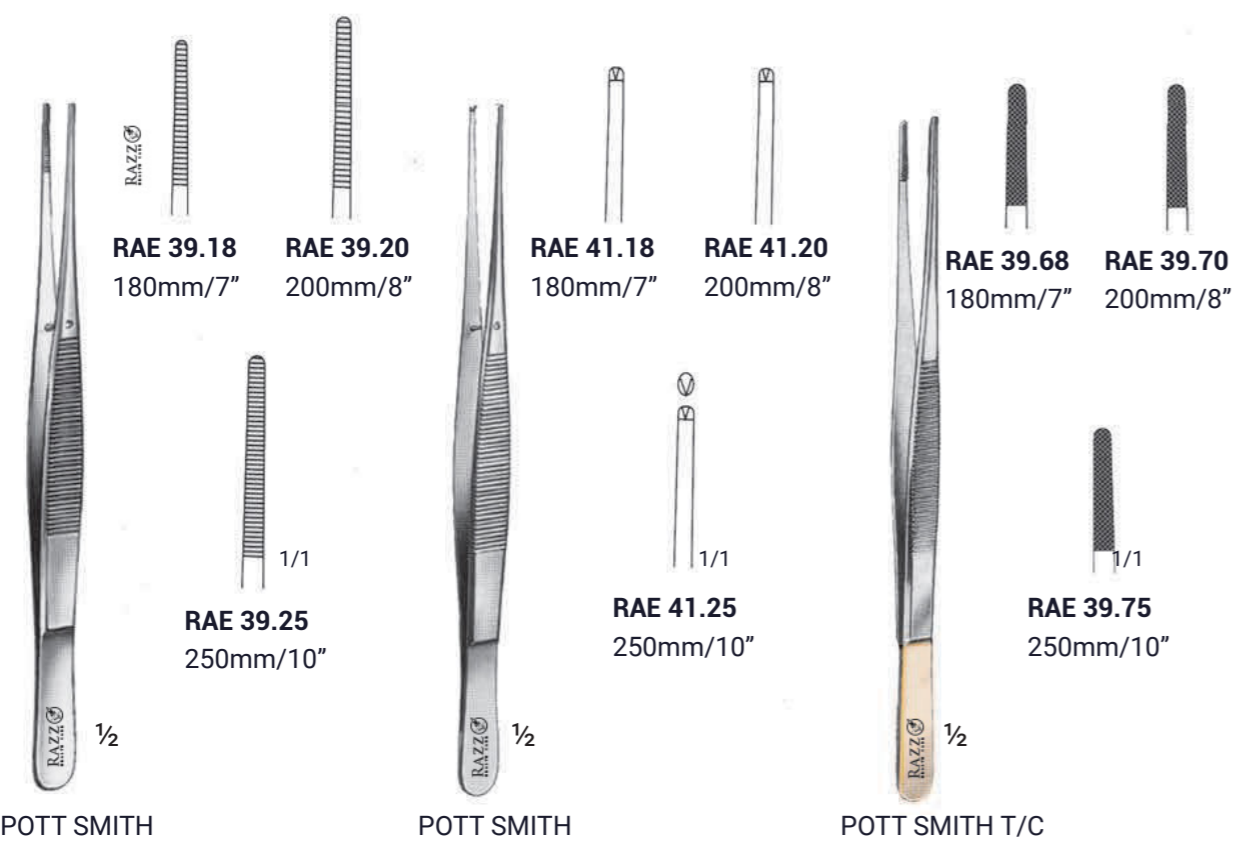

POTT SMITH POTT SMITH POTT SMITH T/C

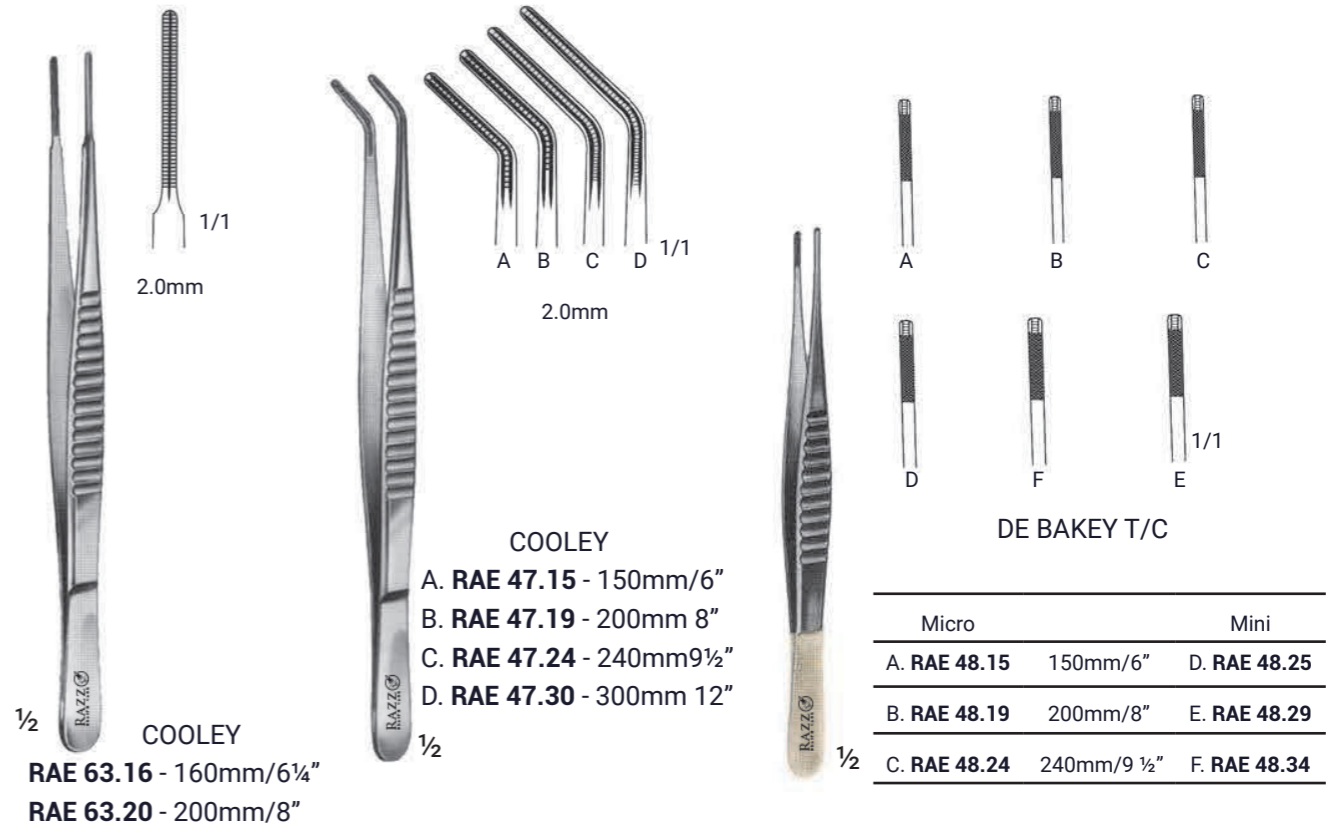

COOLEY		DE BAKKEY T/C	
A. RAE 47.15 - 150mm/6"	B. RAE 47.19 - 200mm 8"		
C. RAE 47.24 - 240mm9 1/2"	D. RAE 47.30 - 300mm 12"		
RAE 63.16 - 160mm/6 1/4"			
RAE 63.20 - 200mm/8"			
		Micro	Mini
		A. RAE 48.15 150mm/6"	D. RAE 48.25
		B. RAE 48.19 200mm/8"	E. RAE 48.29
		C. RAE 48.24 240mm/9 1/2"	F. RAE 48.34

DELICATE TISSUE FORCEPS & T/C

TISSUE GRASPING FORCEPS & T/C



GEARLD
180mm/ 7"

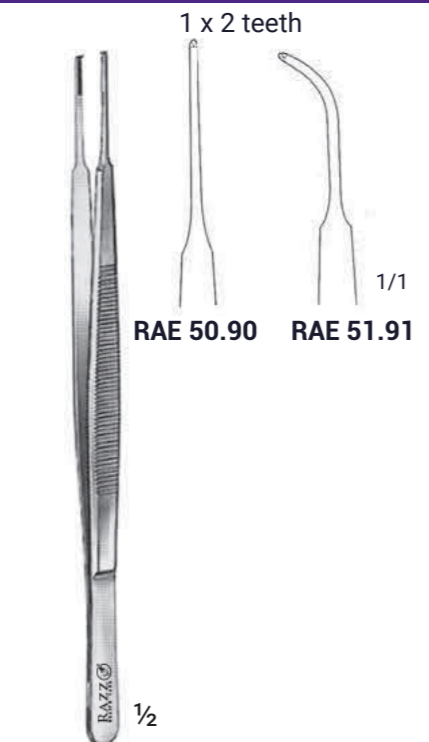

GEARLD
180mm/ 7"



GEARLD T/C
180mm/7"



BONNEY
180mm/7"



BONNEY T/C
180mm/7"



TOYLOR
175mm/7"



TOYLOR
175mm/7"



CUSHING
175mm/7"



CUSHING
175mm/7"



CUSHING T/C
175mm/7"



TOYLOR
175mm/7"



TOYLOR
175mm/7"



TOYLOR
175mm/7"



TOYLOR
175mm/7"



TOYLOR T/C
175mm 7"









HEMOSTATIC FORCEPS

ARTERY FORCEPS



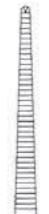



HALSTEAD MOSQUITO

			
RAH 10.12 125mm/5"	RAH 12.12 140mm/5 1/2"	RAH 11.12 125mm/5"	RAH 13.12 140mm/5 1/2"
			
RAH 18.12 125mm/5"	RAH 18.14 140mm/5 1/2"	RAH 19.12 125mm/5"	RAH 19.14 140mm/5 1/2"
1 x 2 teeth	1 x 2 teeth	1 x 2 teeth	1 x 2 teeth



HALSTEAD MOSQUITO

	
RAH 10.22 125mm/5"	RAH 13.22 125mm/5"
	
RAH 18.22 125mm/5"	RAH 19.22 125mm/5"
1 x 2 teeth	1 x 2 teeth

ARTERY FORCEPS

ARTERY FORCEPS

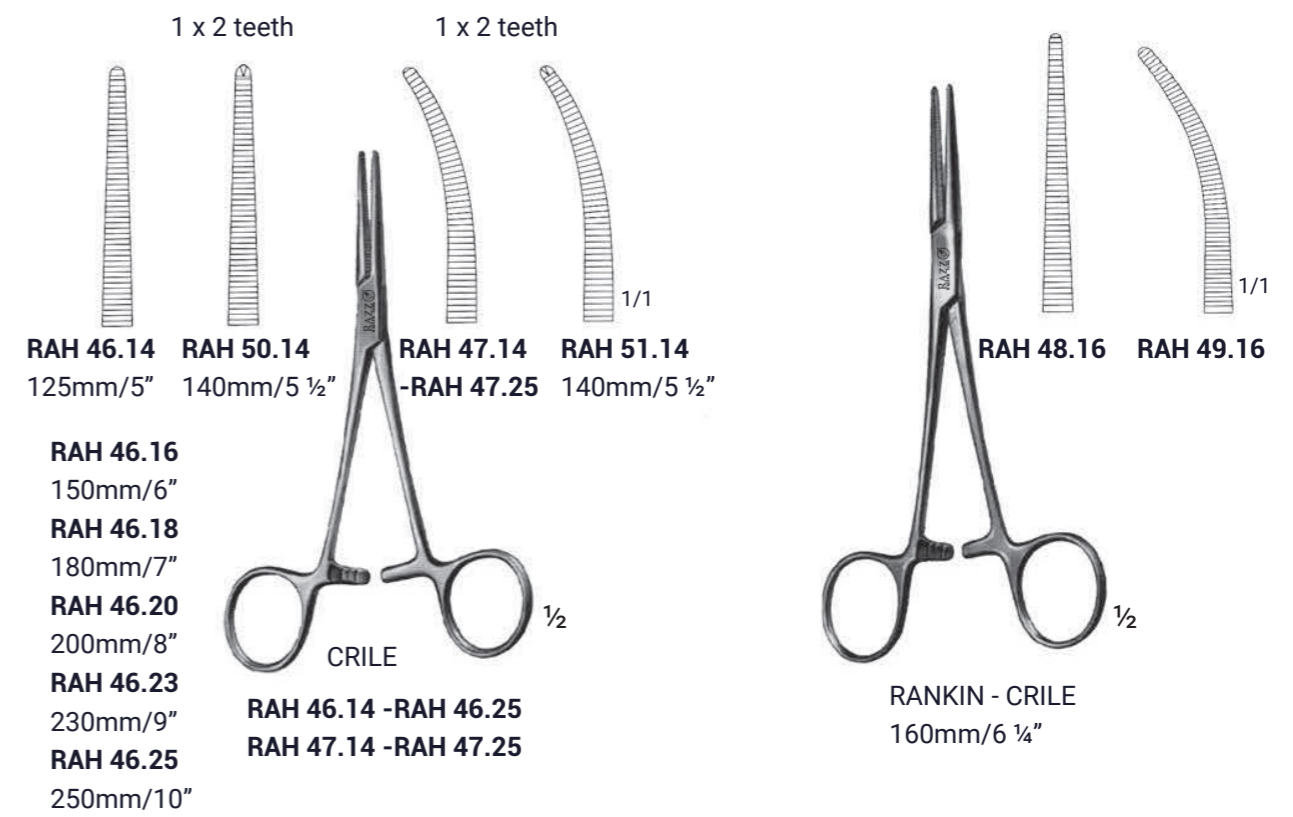
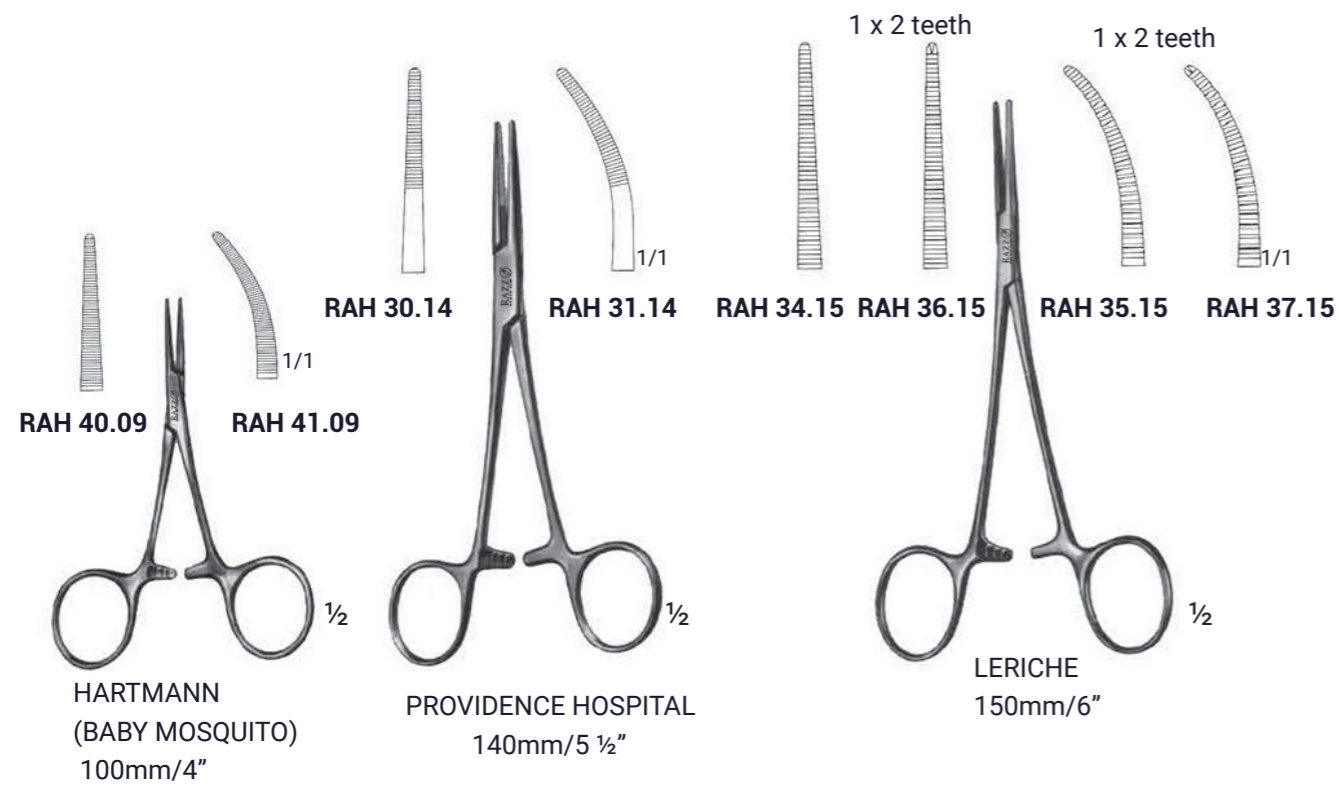
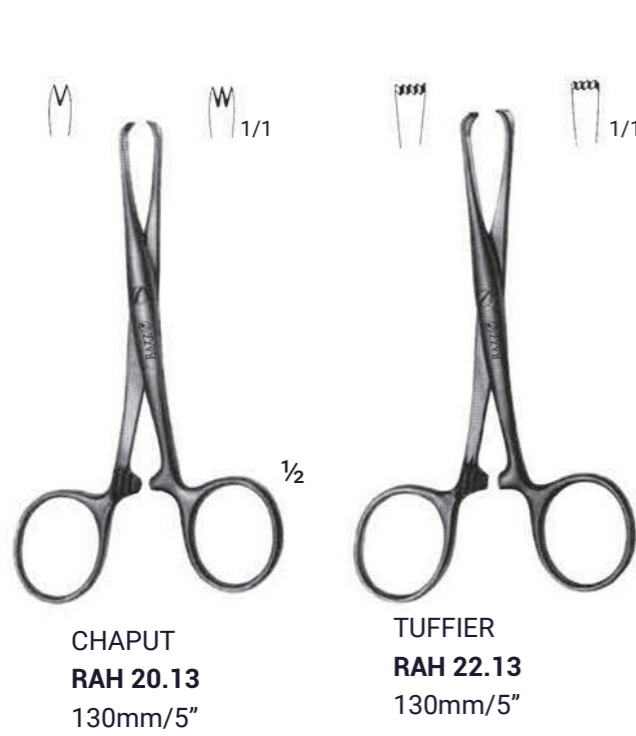

ARTERY FORCEPS

ARTERY FORCEPS

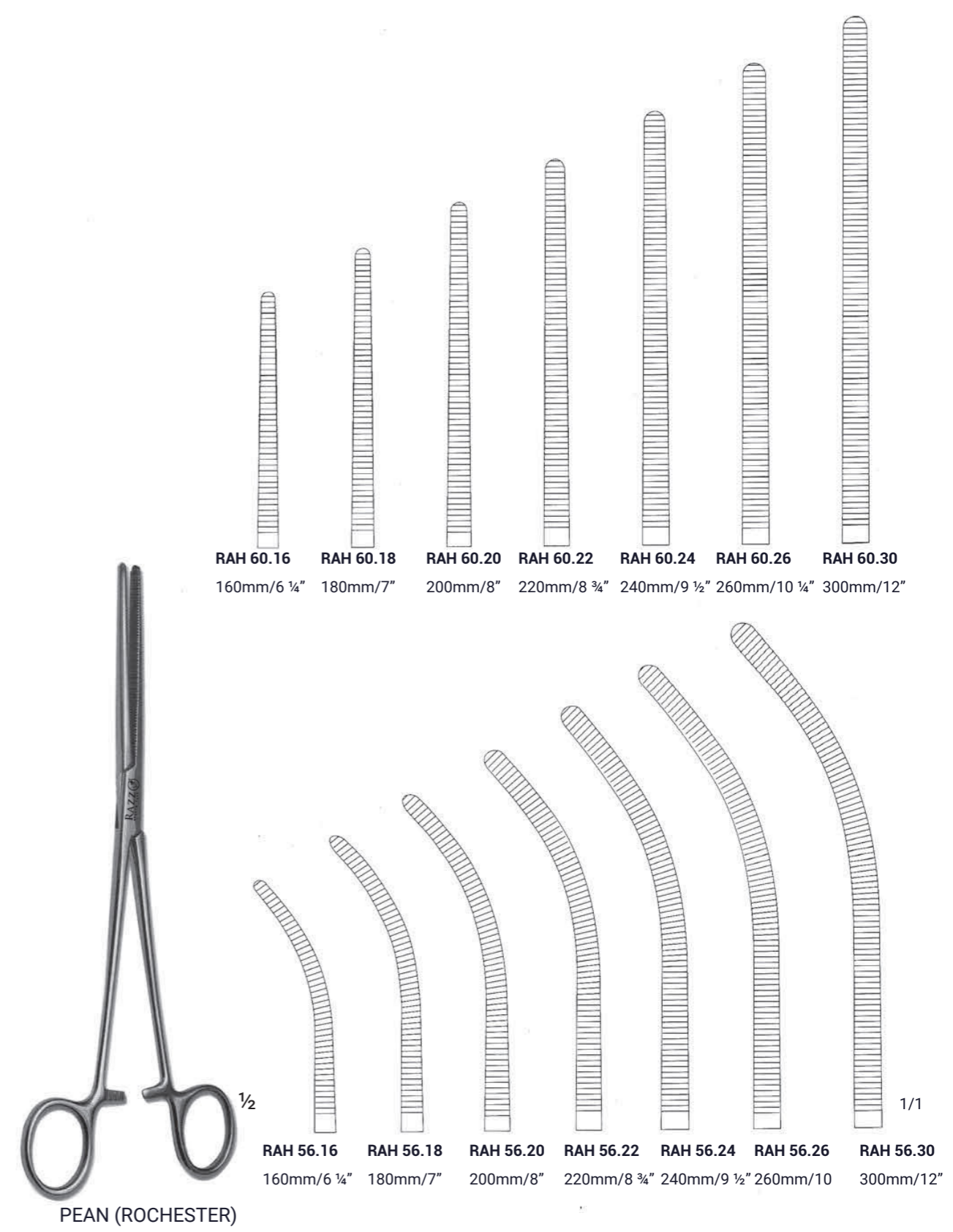
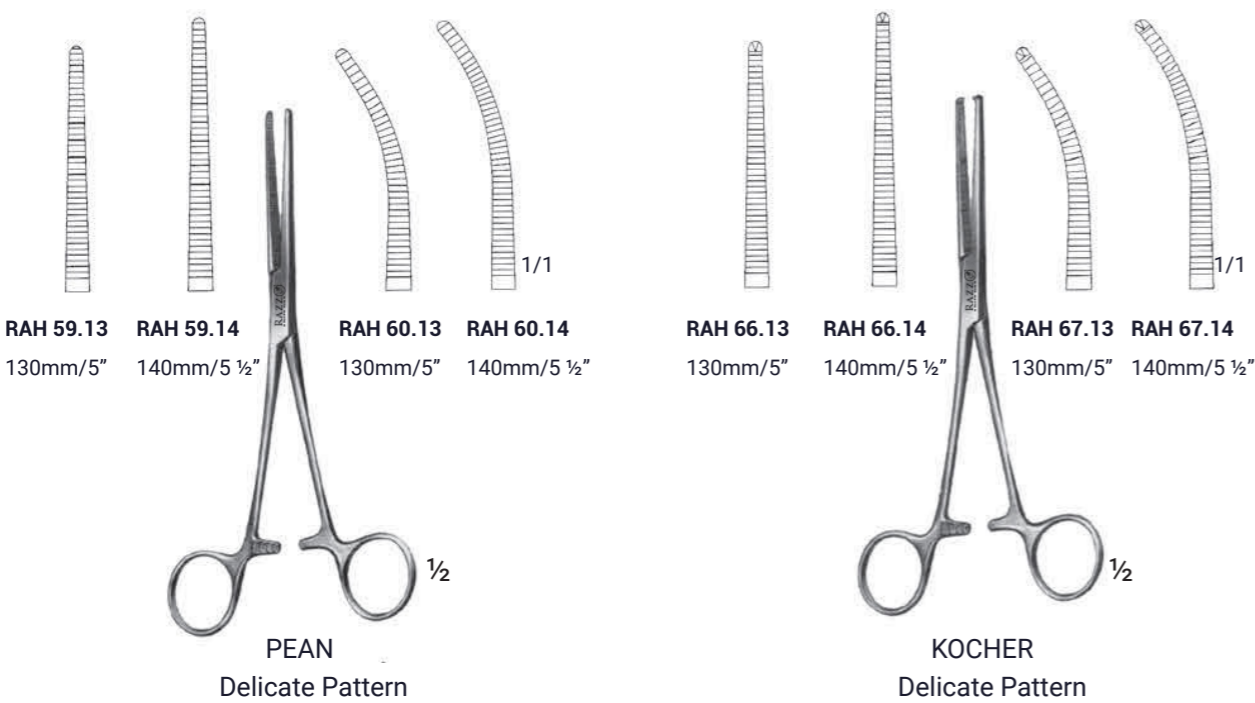
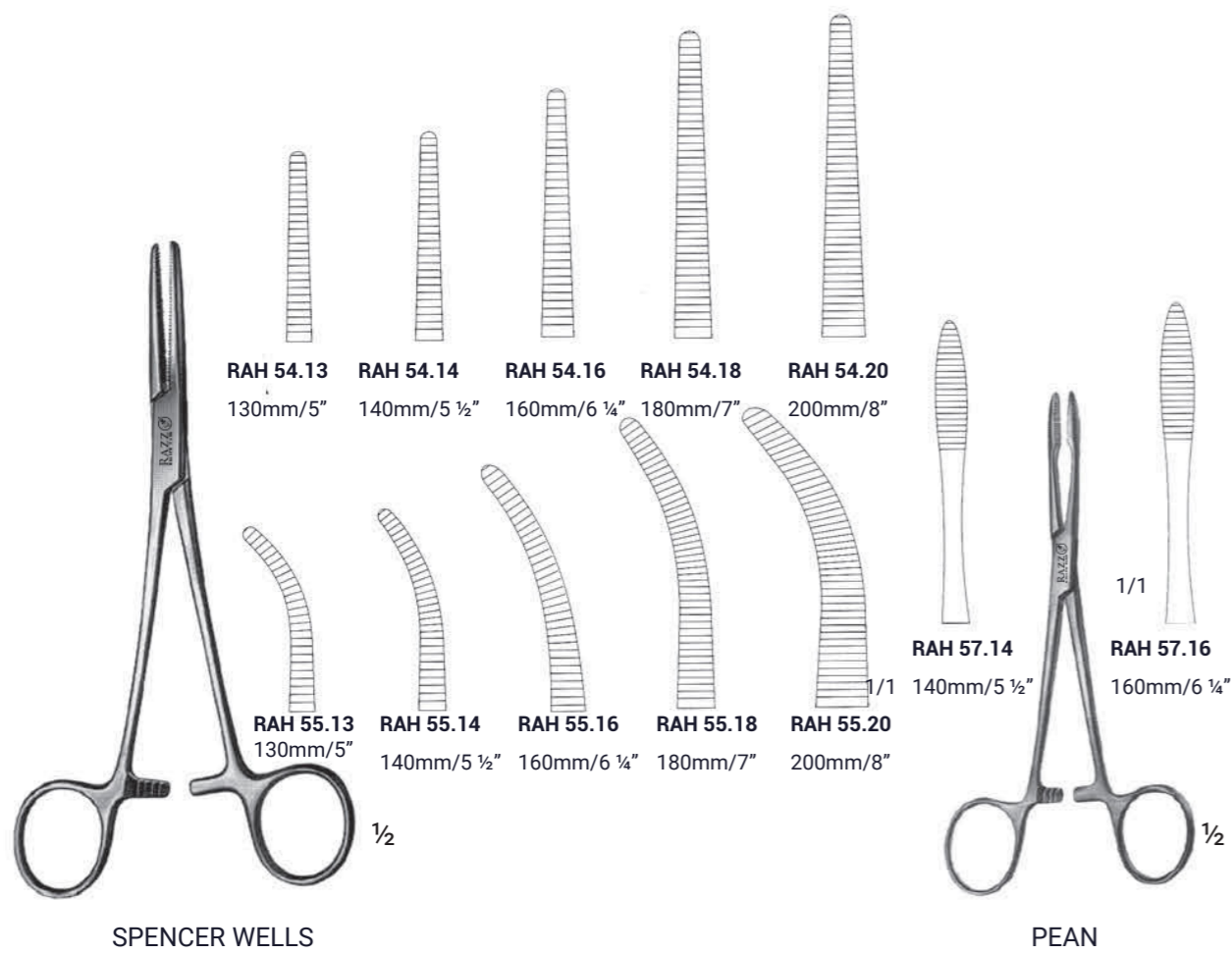

ARTERY FORCEPS

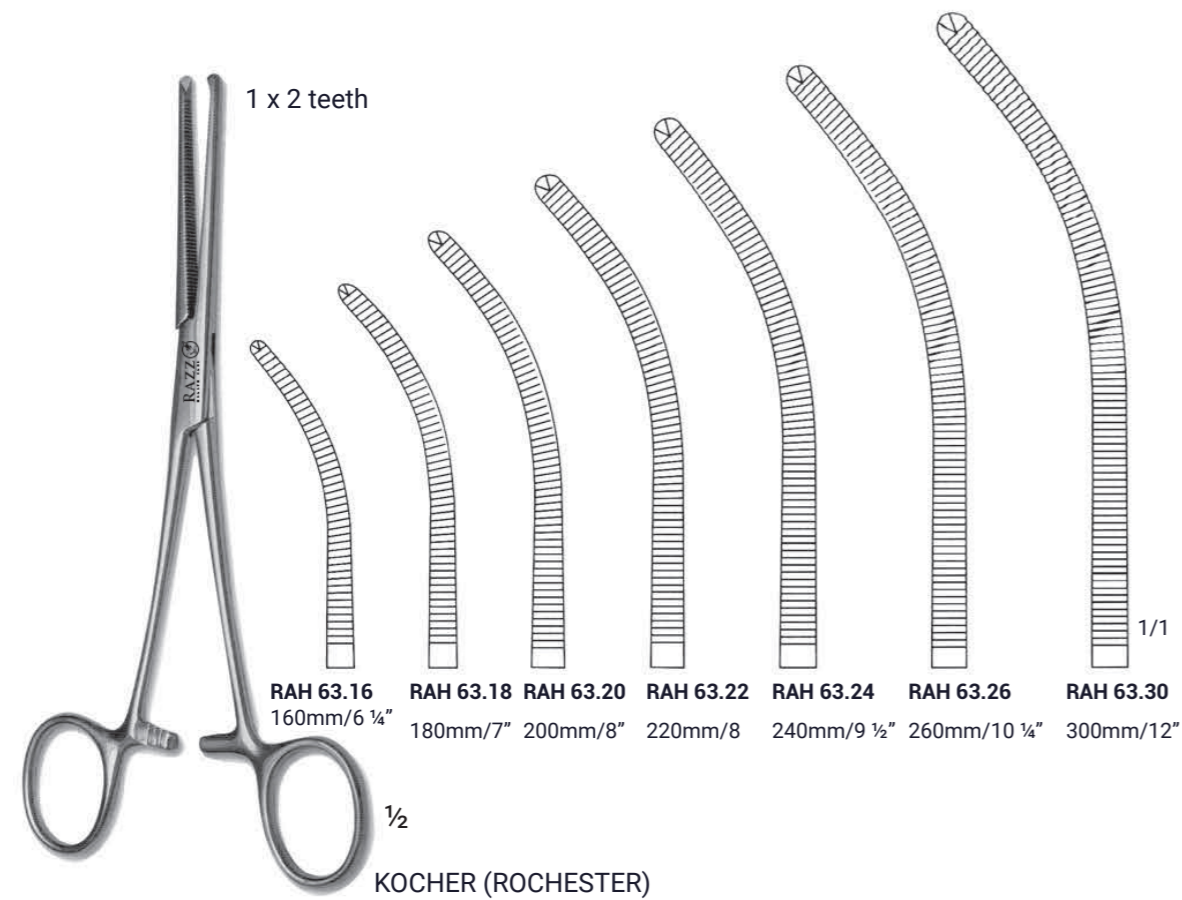
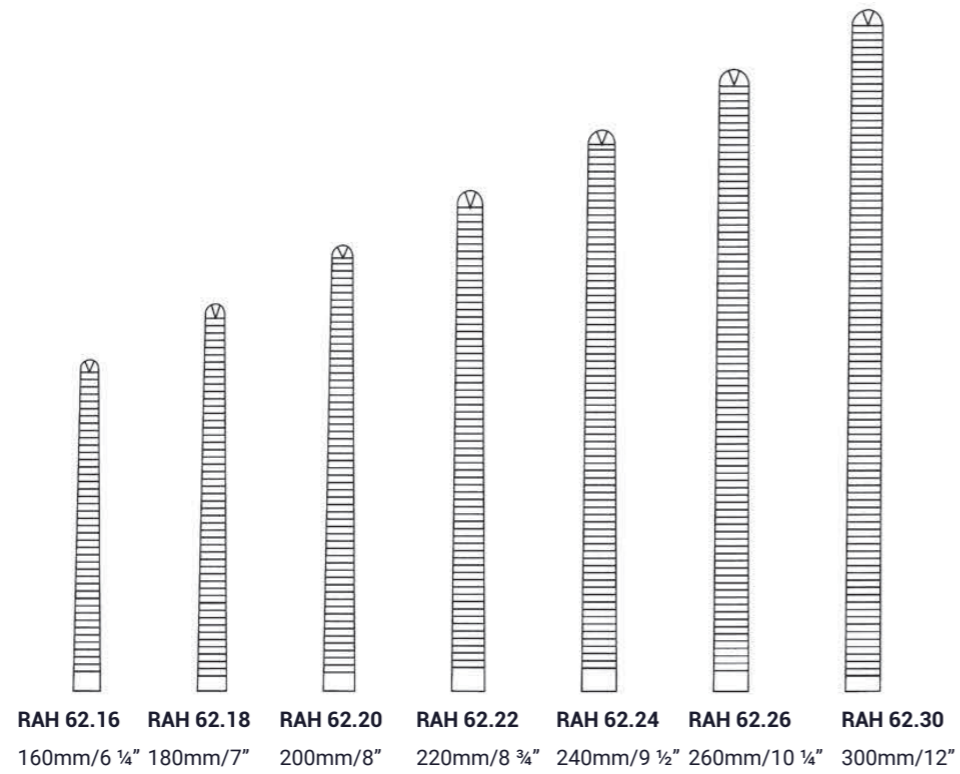

ARTERY FORCEPS

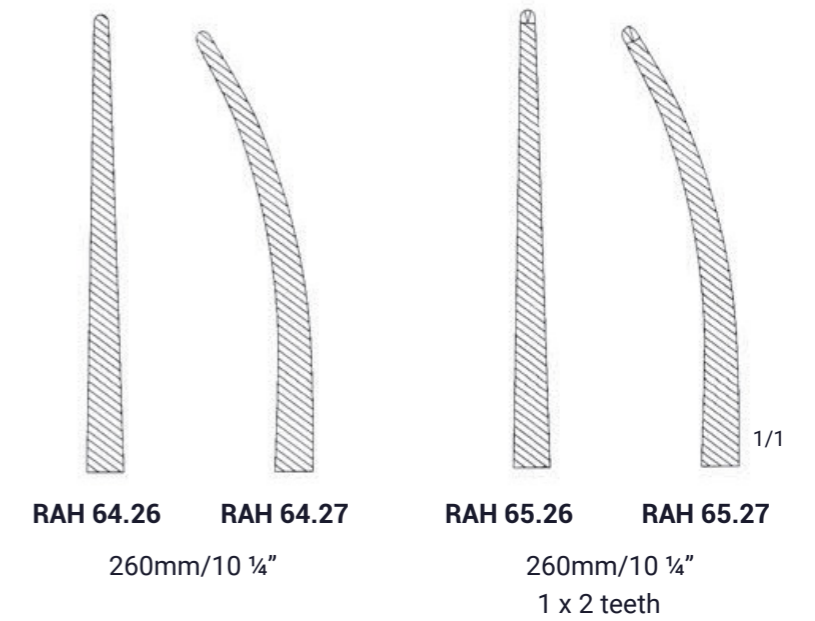
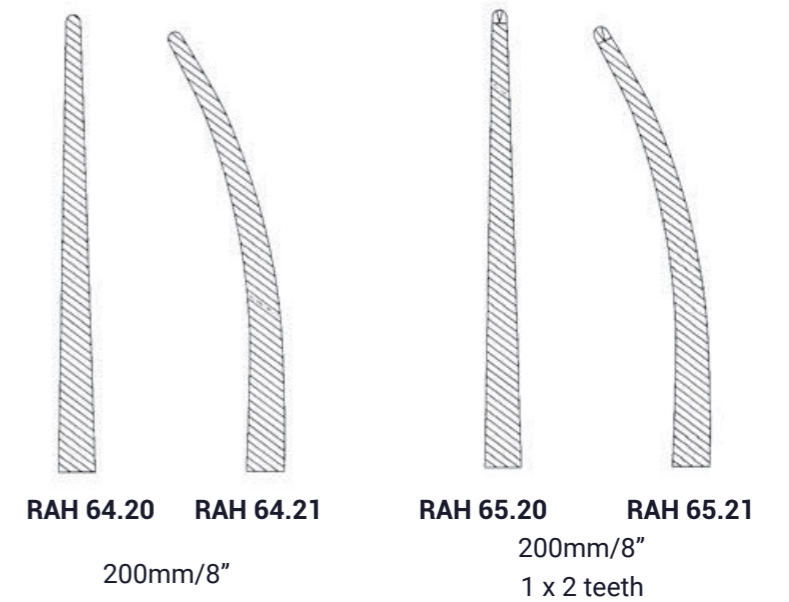

ARTERY FORCEPS, DISSECTING & LIGATURE FORCEPS

ARTERY FORCEPS & CLAMPS



RAH 68.29 RAH 68.30

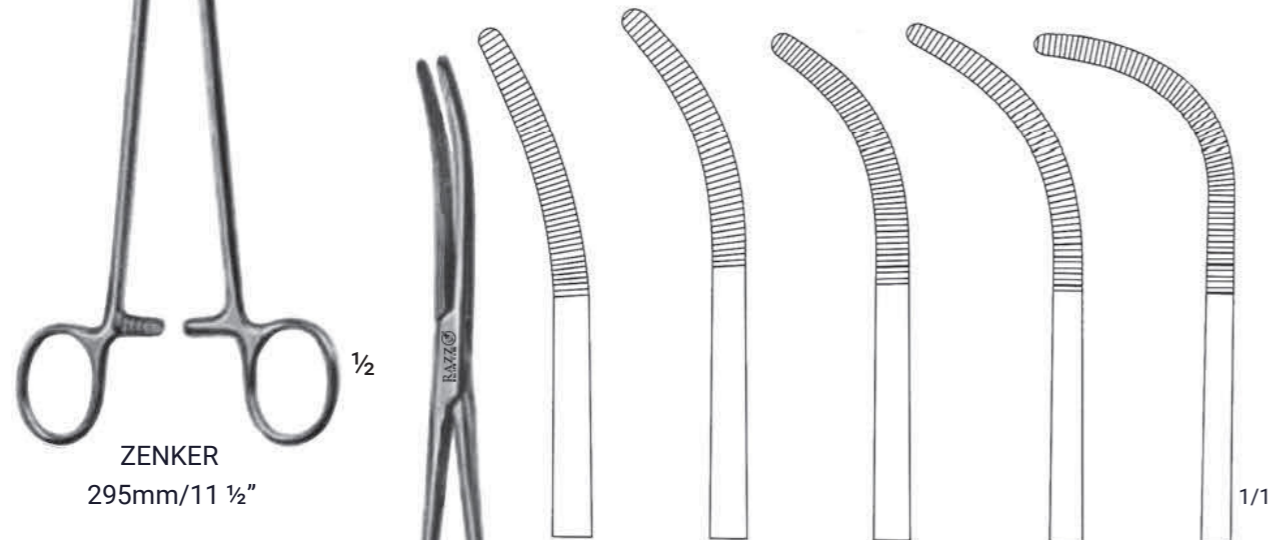

RAH 69.01 RAH 69.02 RAH 69.03 RAH 69.04 RAH 69.05

ZENKER
295mm/11 1/2"



RUMEL
230mm/9"

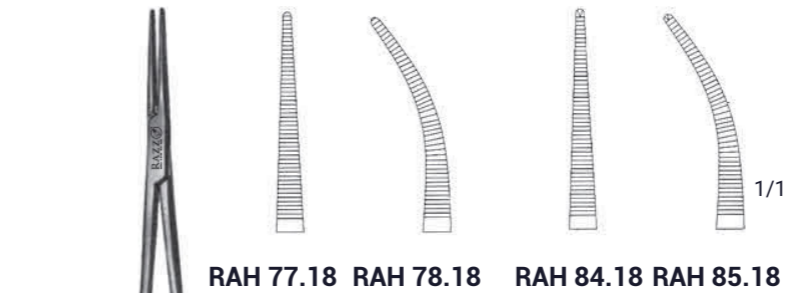

RAH 77.18 RAH 78.18 RAH 84.18 RAH 85.18

HALSTEAD (ADSON)
180mm/7"

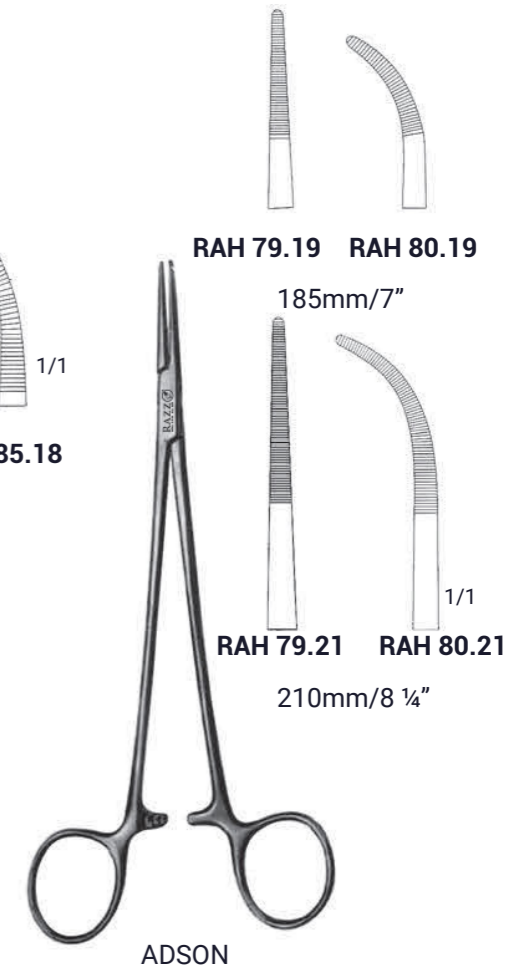

RAH 79.19 RAH 80.19
185mm/7"
RAH 79.21 RAH 80.21
210mm/8 1/4"

ADSON

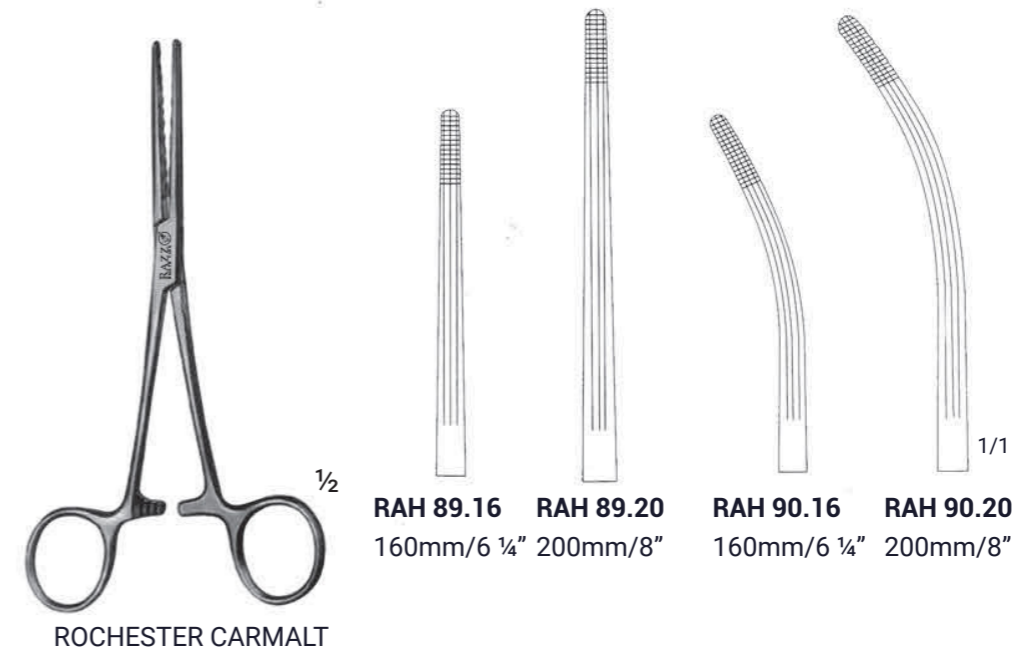

RAH 89.16 RAH 89.20 RAH 90.16 RAH 90.20
160mm/6 1/4" 200mm/8" 160mm/6 1/4" 200mm/8"

ROCHESTER CARMALT

INTESTINAL & TISSUE FORCEPS

TISSUE HOLDING FORCEPS

3 x 4



1/1





ALLIS - BABY

RAN 01.14 - 140mm/5 1/2"



4 x 5



5 x 6



1/1

ALLIS

RAN 02.15 - 150mm/6"

RAN 02.16 - 150mm/6"

RAN 02.19 - 200mm/8"

RAN 02.23 - 230mm/9"

5 x 6 teeth







1/1





BOYS - ALLIS

RAN 04.15 - 150mm/6"

Atraumatic

1/1







ALLIS - ATRAUMA

RAN 11.16 - 150mm/6"

RAN 11.19 - 200mm/8"

RAN 11.25 - 250mm/10"

RAN 11.30 - 300mm/12"

BABCOCK

RAN 13.16 - 160mm/6 1/4"

RAN 13.18 - 180mm/7"

RAN 14.20 - 200mm/8"

RAN 14.23 - 230mm/9"





WILLIAMS

RAN 05.16 - 160mm/6 1/4"

9 x 10 teeth



1/1



ALLIS - ADAIR

RAN 06.15 - 150mm/6"

6 x 7 teeth







1/1





THOMS - ALLIS

RAN 07.20 - 200mm/8"

Atraumatic

1/1

BABCOCK 'ATRAUMA'

RAN 15.16 - 160mm/6 1/4"

RAN 15.20 - 200mm/8"





1/1





BABCOCK, T/C

RAN 16.16 - 160mm/6 1/4"

RAN 16.20 - 200mm/8"

ARTERY, HYSTERECTOMY & VAGINAL CLAMP FORCEPS

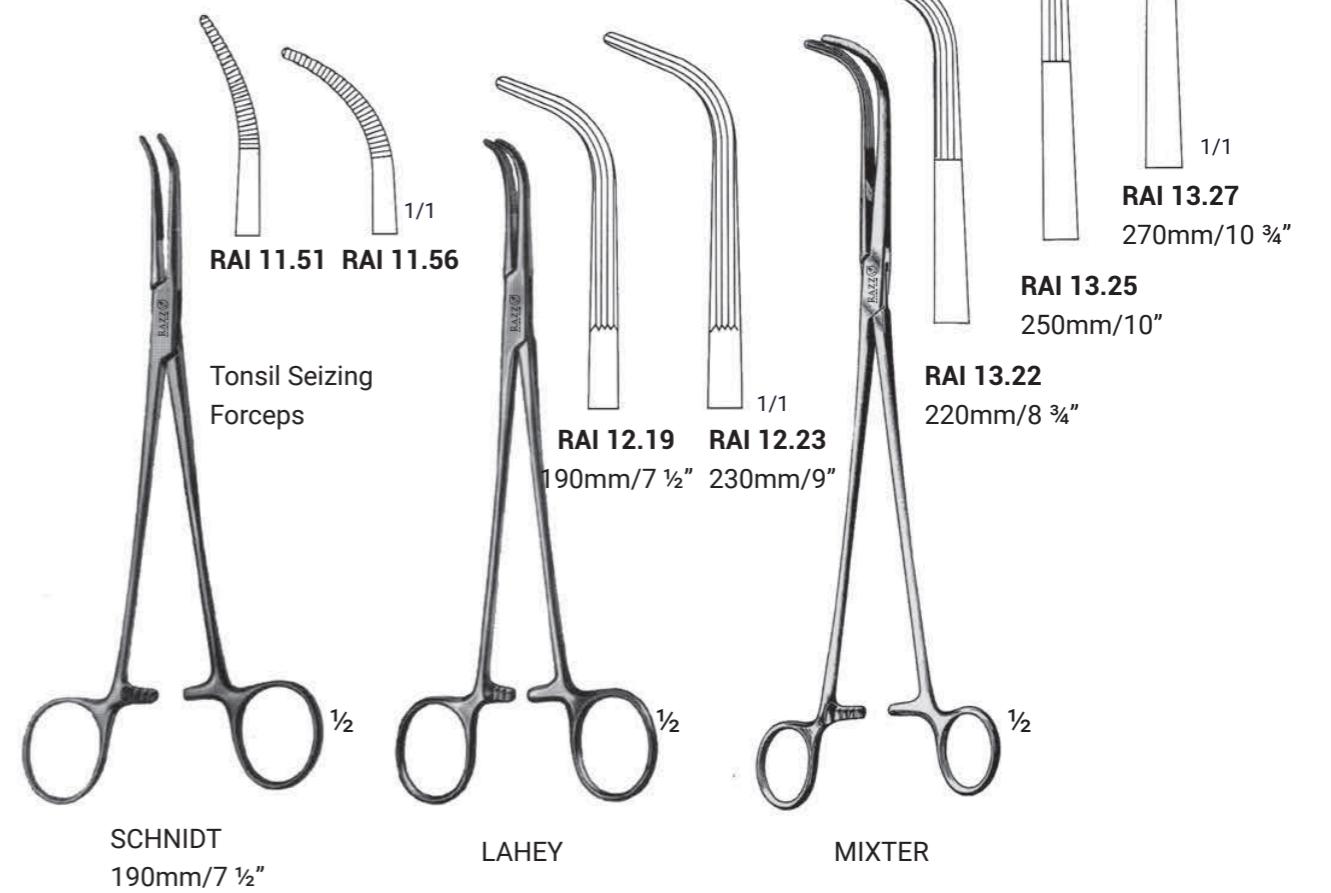
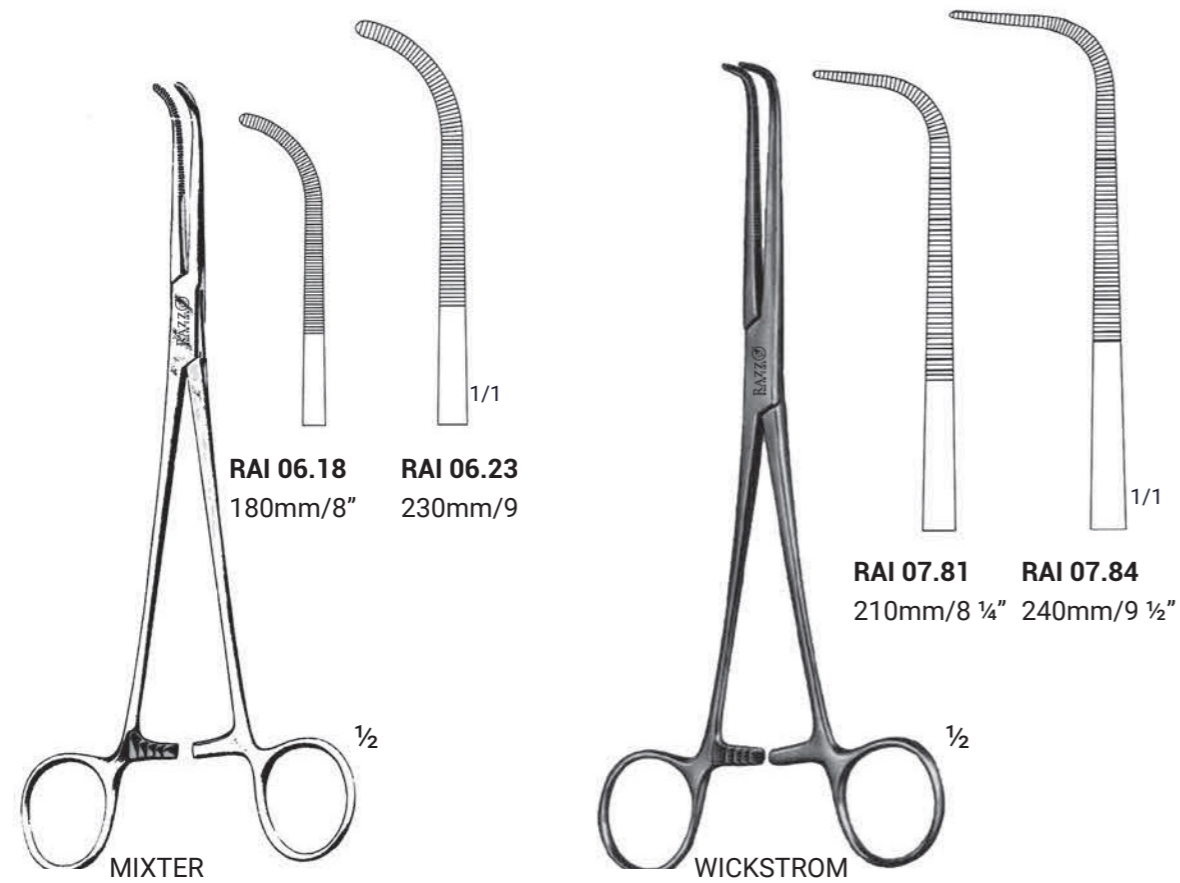
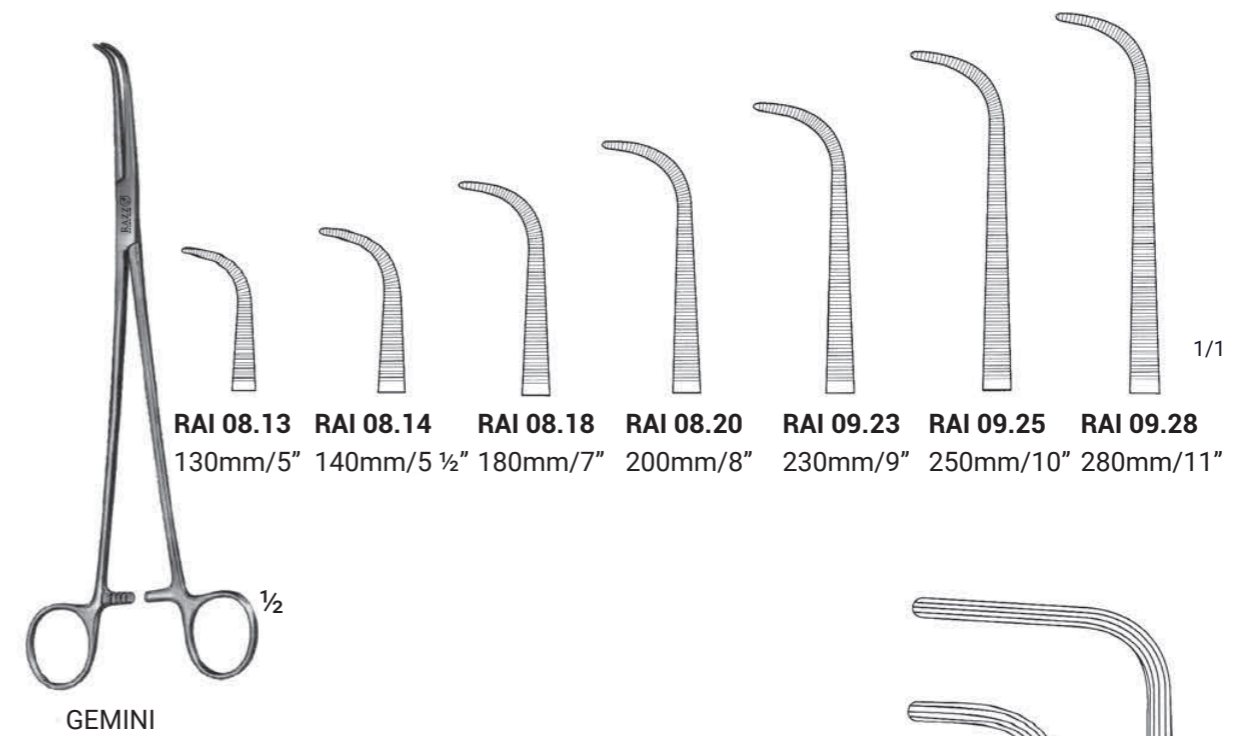
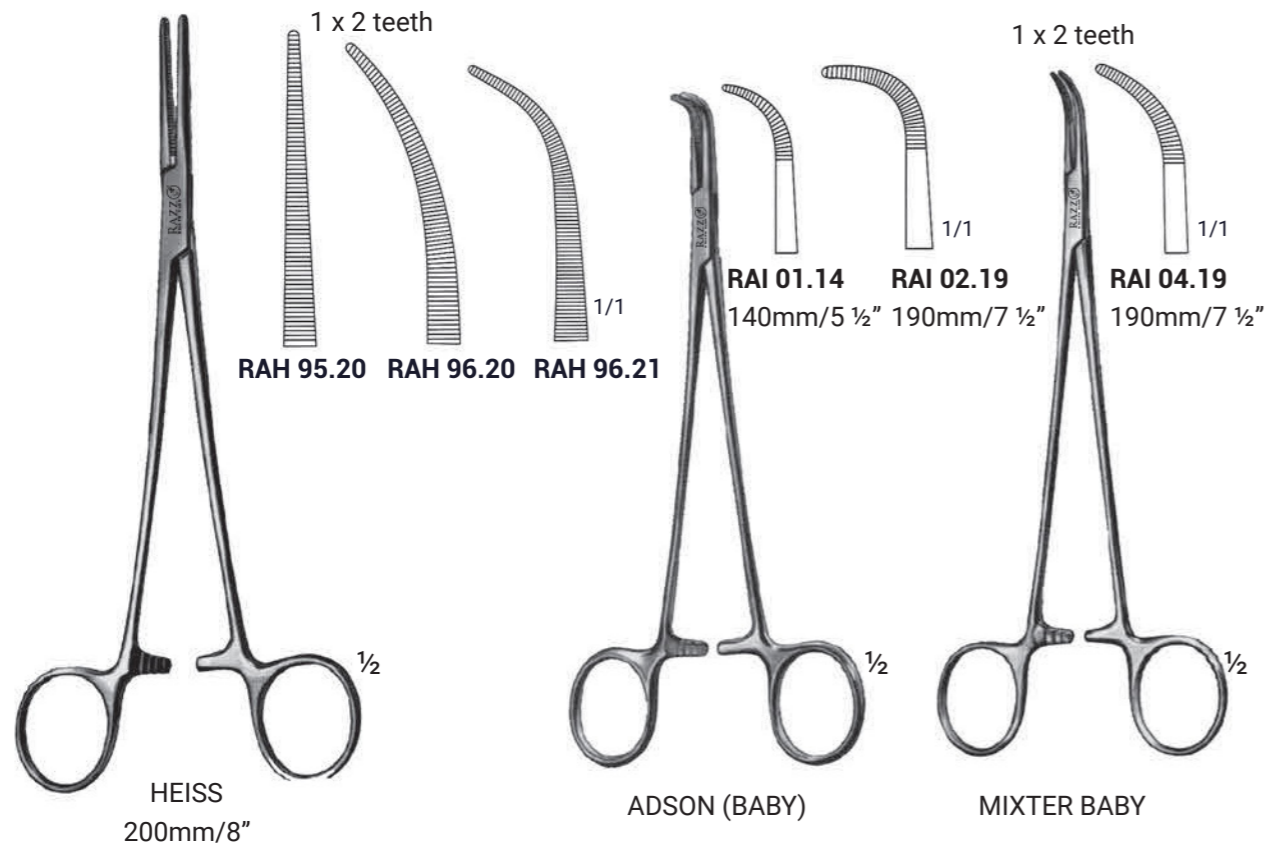
ARTERY, HYSTERECTOMY & VAGINAL CLAMP FORCEPS



TOWEL CLAMPS

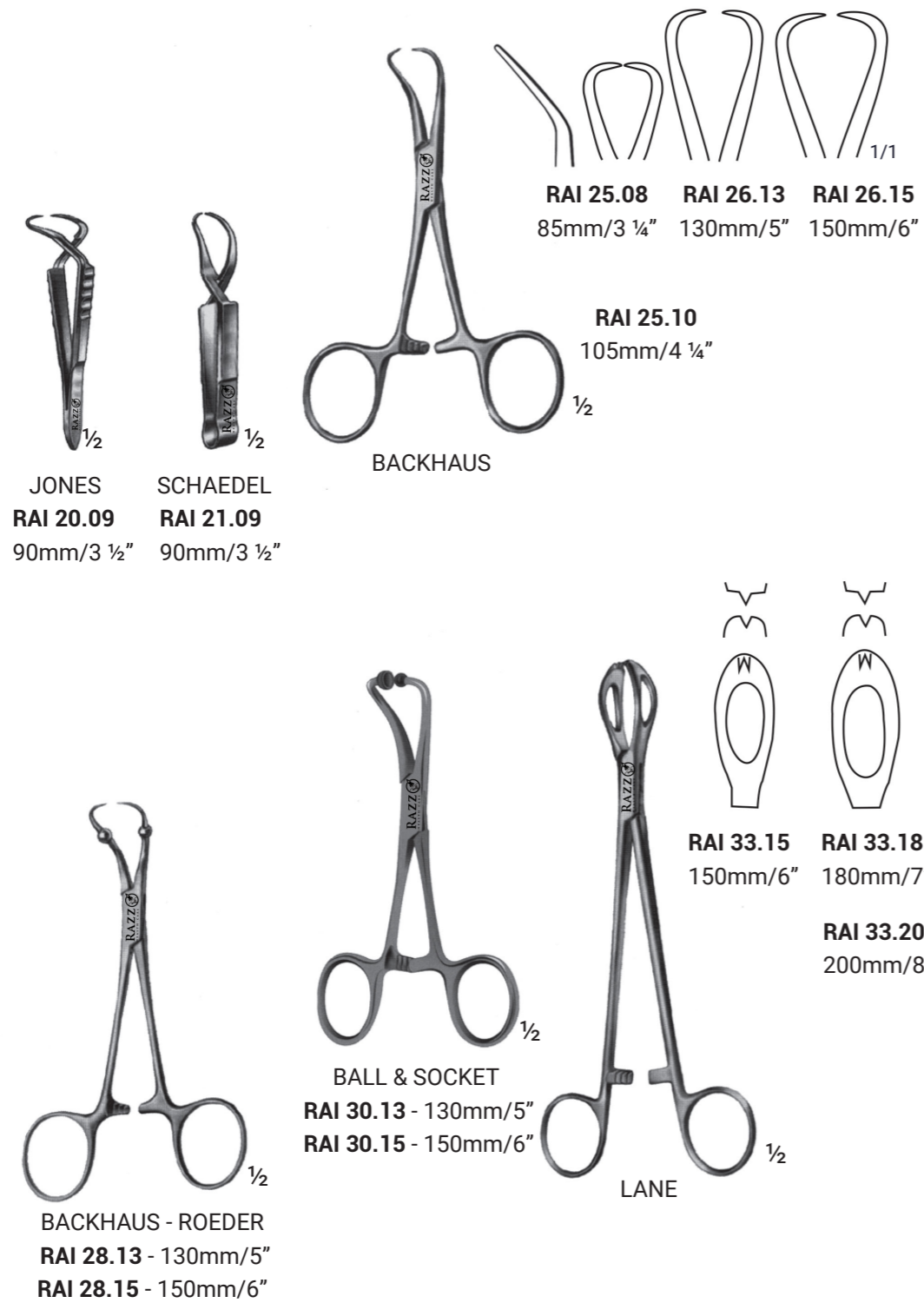

SCISSORS

IRIS SCISSORS & T/C

DELICATE SCISSORS

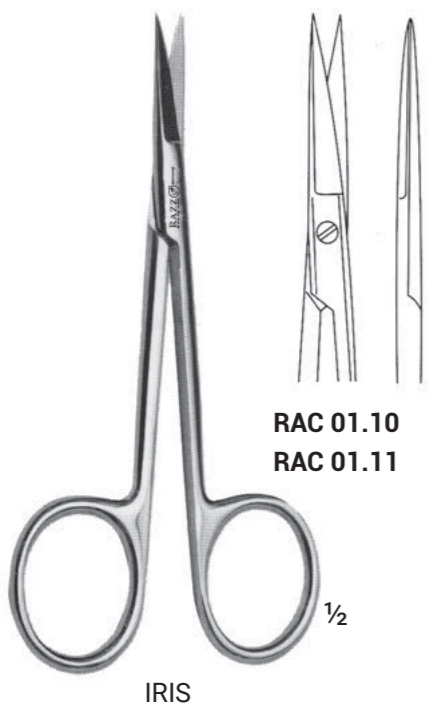

Straight		Curved	
RAC 01.10	105mm / 4 1/8"	RAC 02.10	
RAC 01.11	115mm / 4 1/2"	RAC 02.11	



Straight		Curved	
RAC 05.61	115mm / 4 1/2"	RAC 06.61	

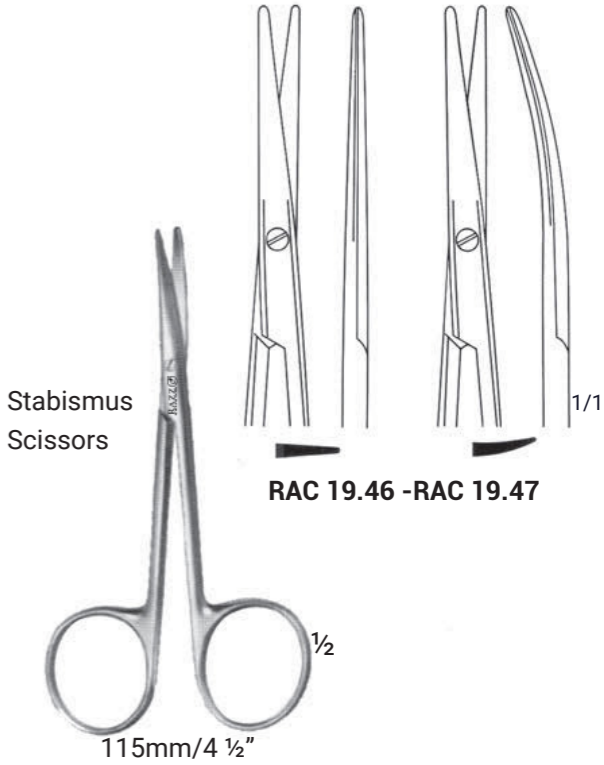
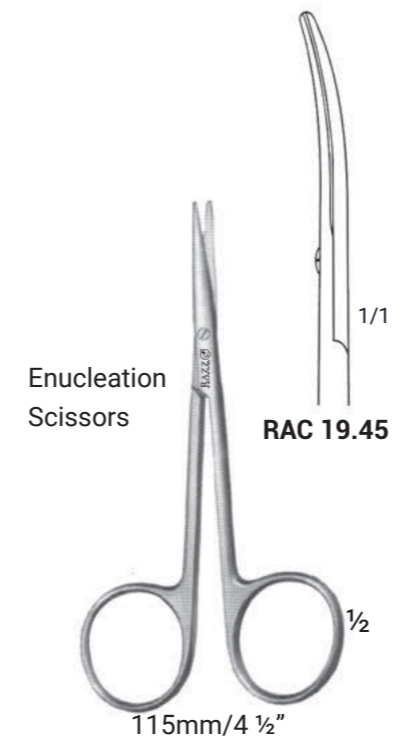
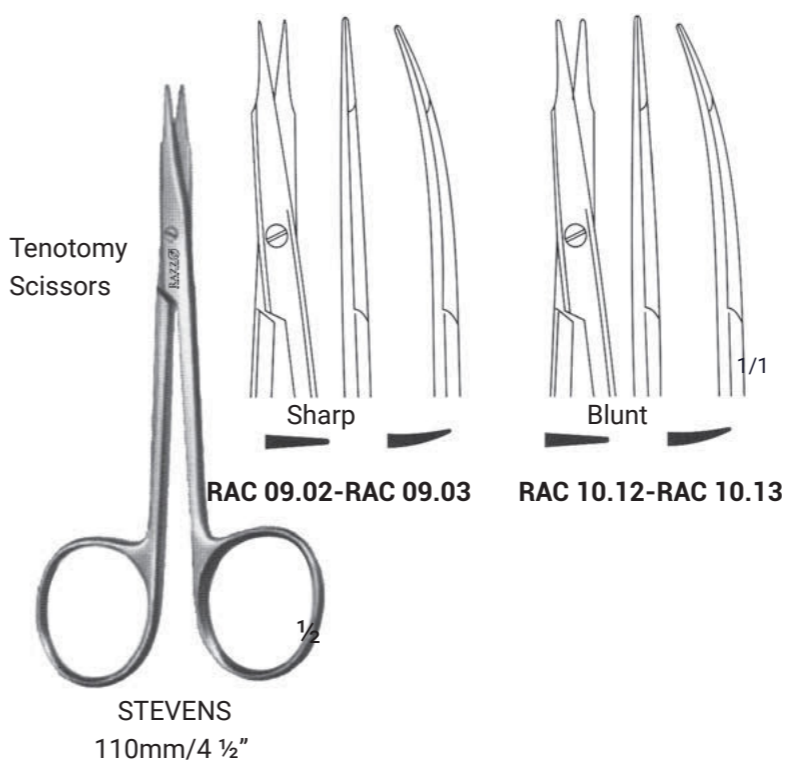

OPERATING SCISSORS

OPERATING SCISSORS, T/C & SUTURE SCISSORS

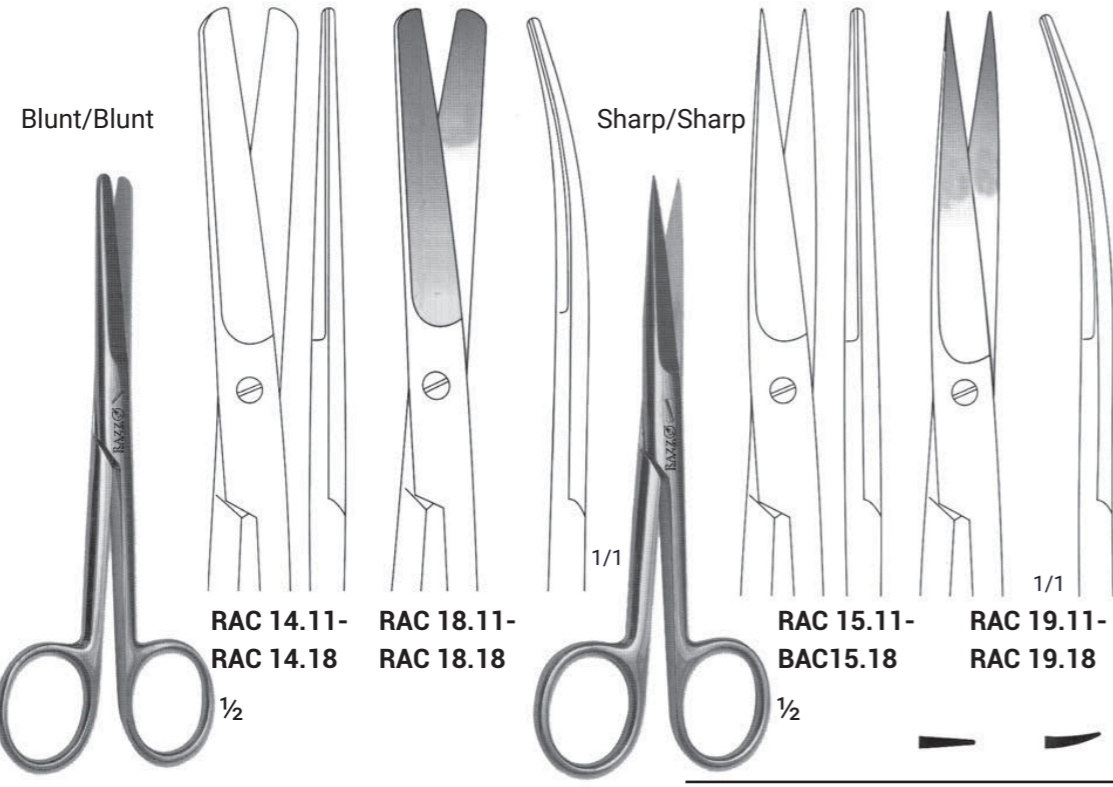

115mm/4 1/2"	RAC 14.11	RAC 18.11
130mm/5"	RAC 14.13	RAC 18.13
145mm/5 3/4"	RAC 14.14	RAC 18.14
150mm/6"	RAC 14.15	RAC 18.15
165mm/6 1/2"	RAC 14.16	RAC 18.16
185mm/7 1/4"	RAC 14.18	RAC 18.18

115mm/4 1/2"	RAC 15.11	RAC 19.11
130mm/5"	RAC 15.13	RAC 19.13
145mm/5 3/4"	RAC 15.14	RAC 19.14
150mm/6"	RAC 15.15	RAC 19.15
165mm/6 1/2"	RAC 15.16	RAC 19.16
185mm/7 1/4"	RAC 15.18	RAC 19.18

Sharp/Blunt

115mm/4 1/2"	RAC 16.11	RAC 17.11
130mm/5"	RAC 16.13	RAC 17.13
145mm/5 3/4"	RAC 16.14	RAC 17.14
150mm/6"	RAC 16.15	RAC 17.15
165mm/6 1/2"	RAC 16.16	RAC 17.16
185mm/7 1/4"	RAC 16.18	RAC 17.18

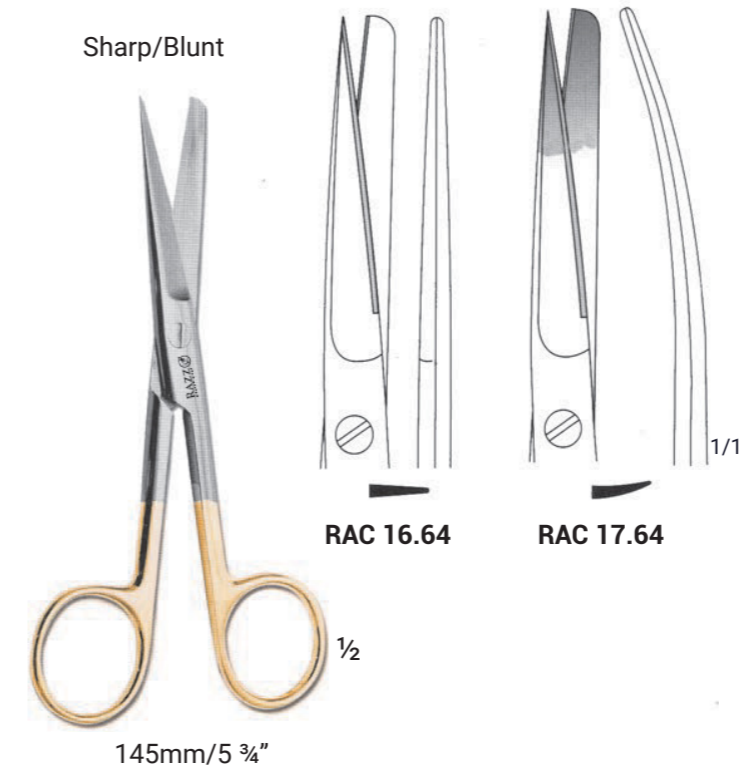

HEATH SCISSOR
SUTURE REMOVAL
RAC 65.42 -150mm/6"
RAC 65.43 -180mm/7"

DISSECTING SCISSORS

DISSECTING SCISSORS WITH T/C

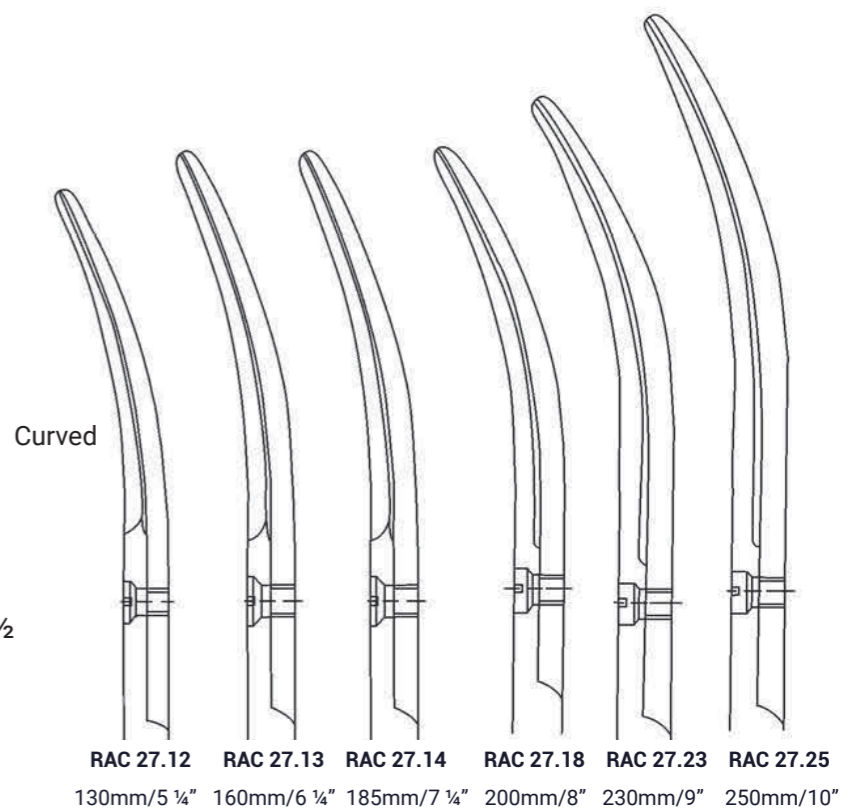
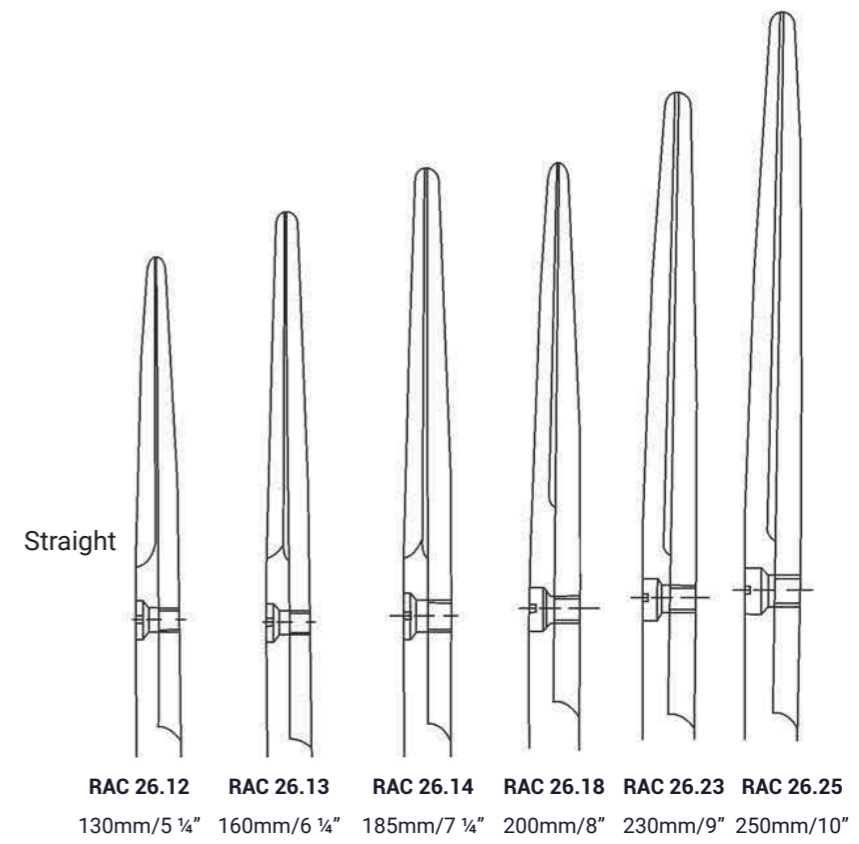
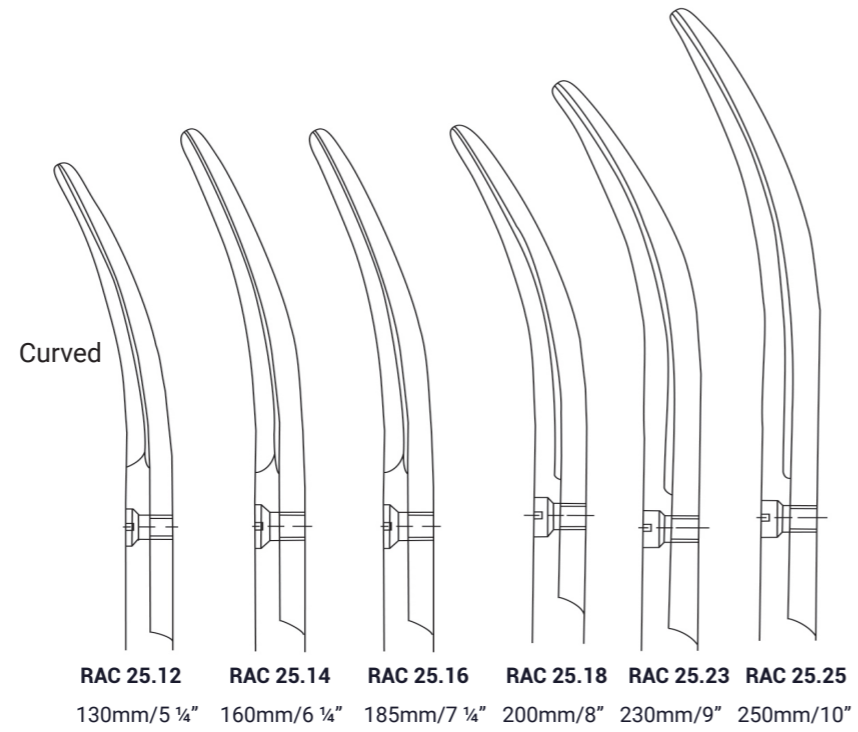
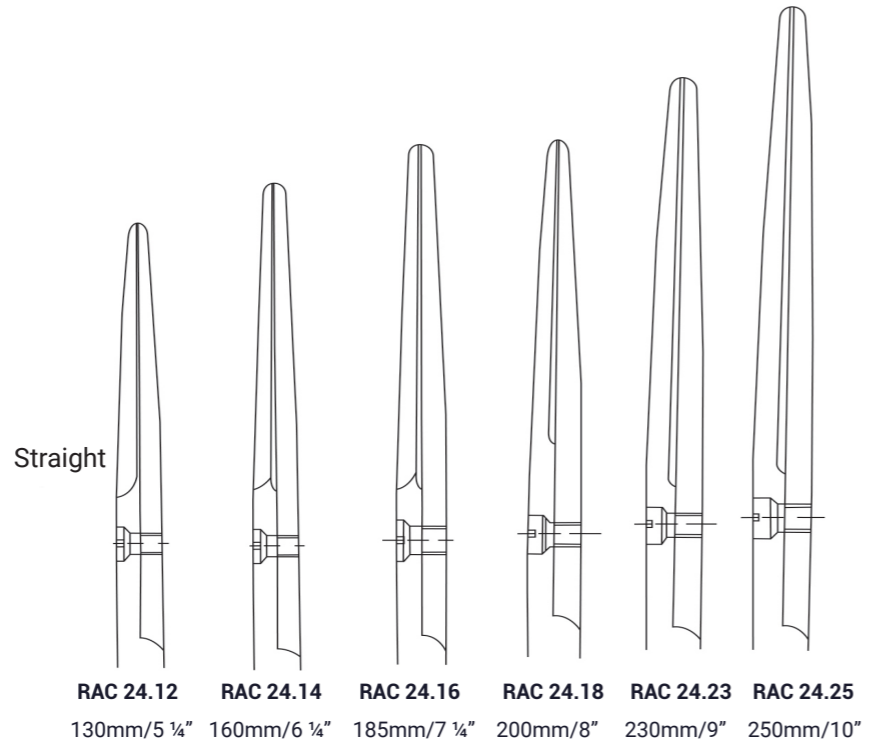

DISSECTING SCISSORS WITH T/C

ABDOMINAL, UTERINE & SCISSORS T/C

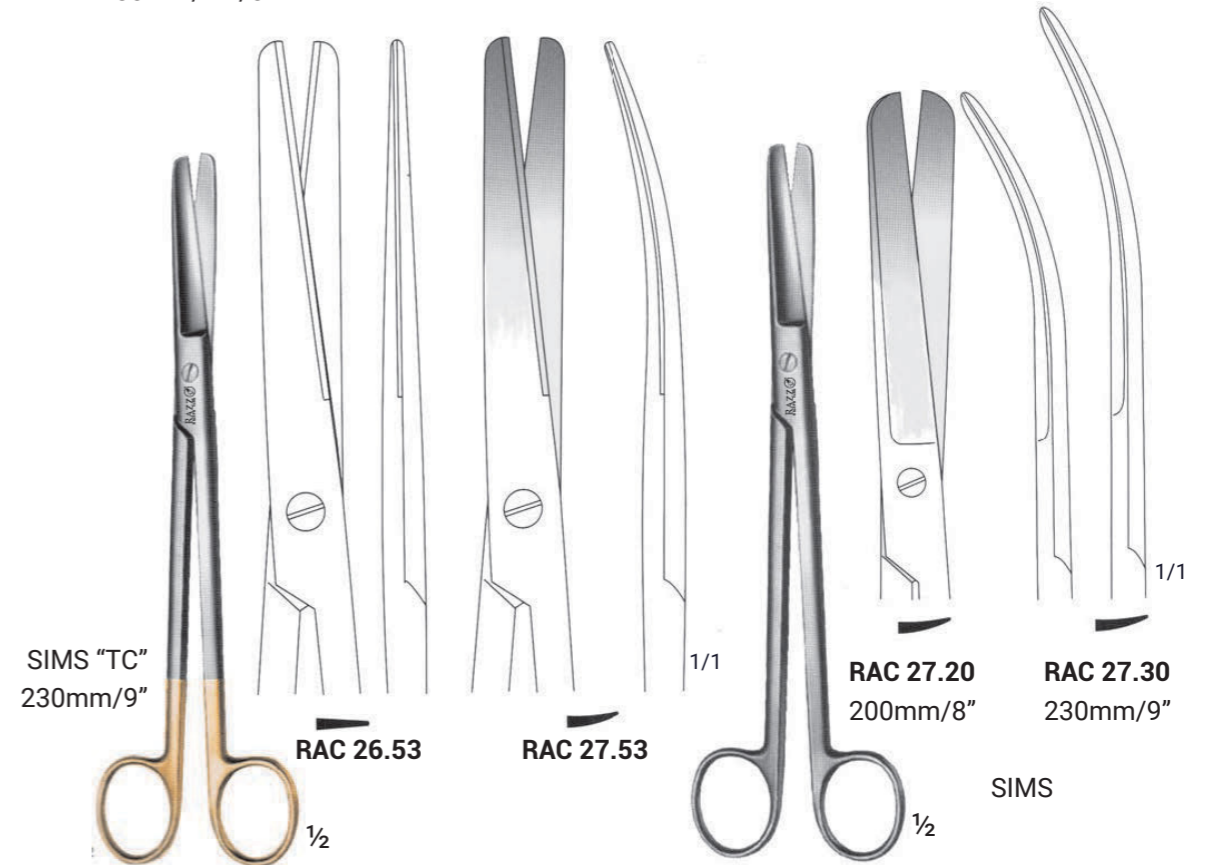
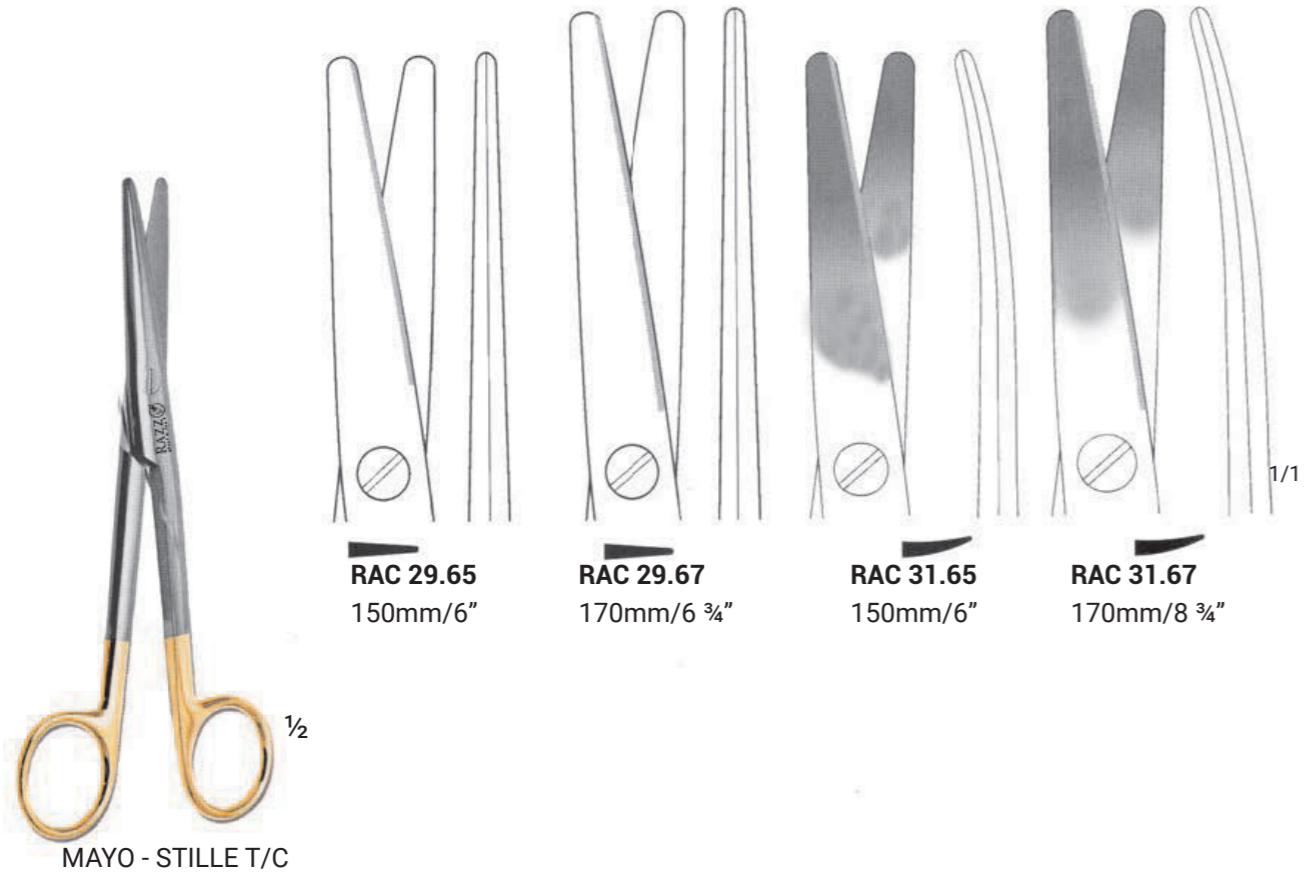
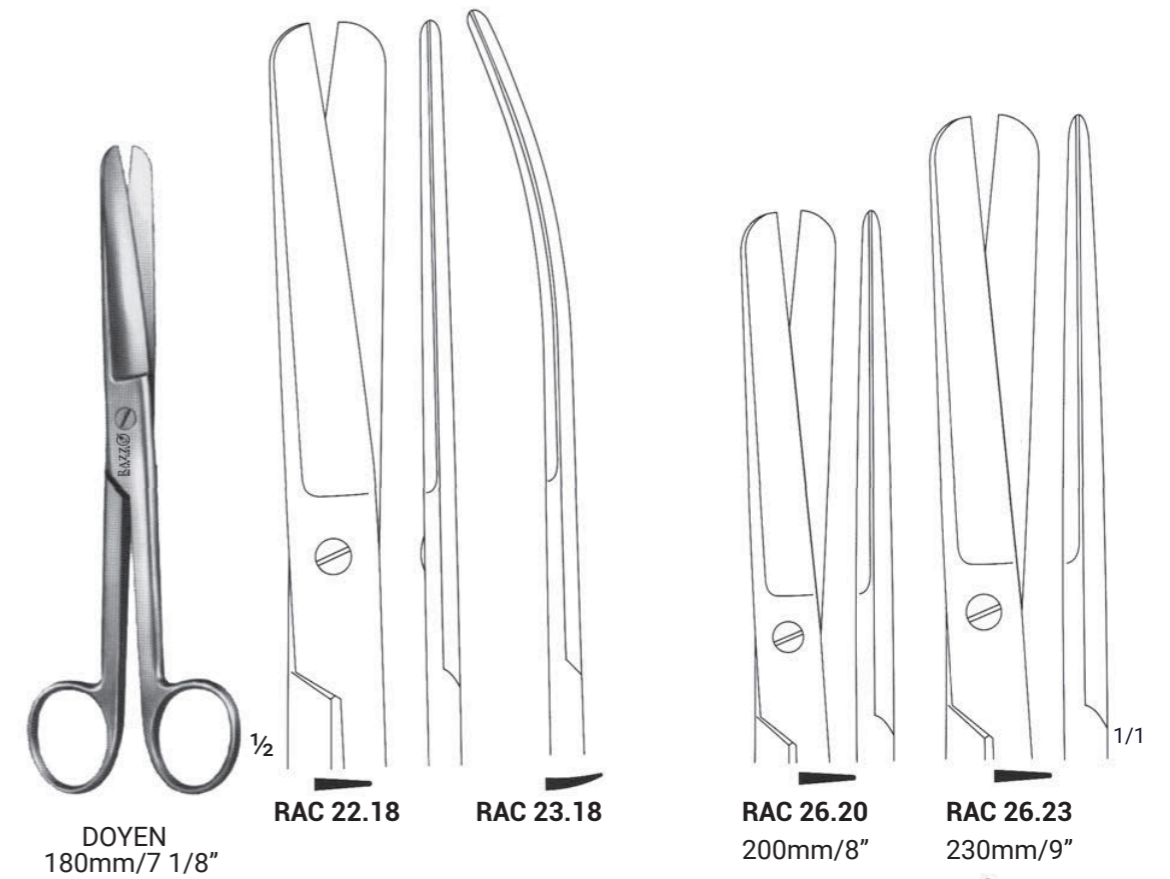
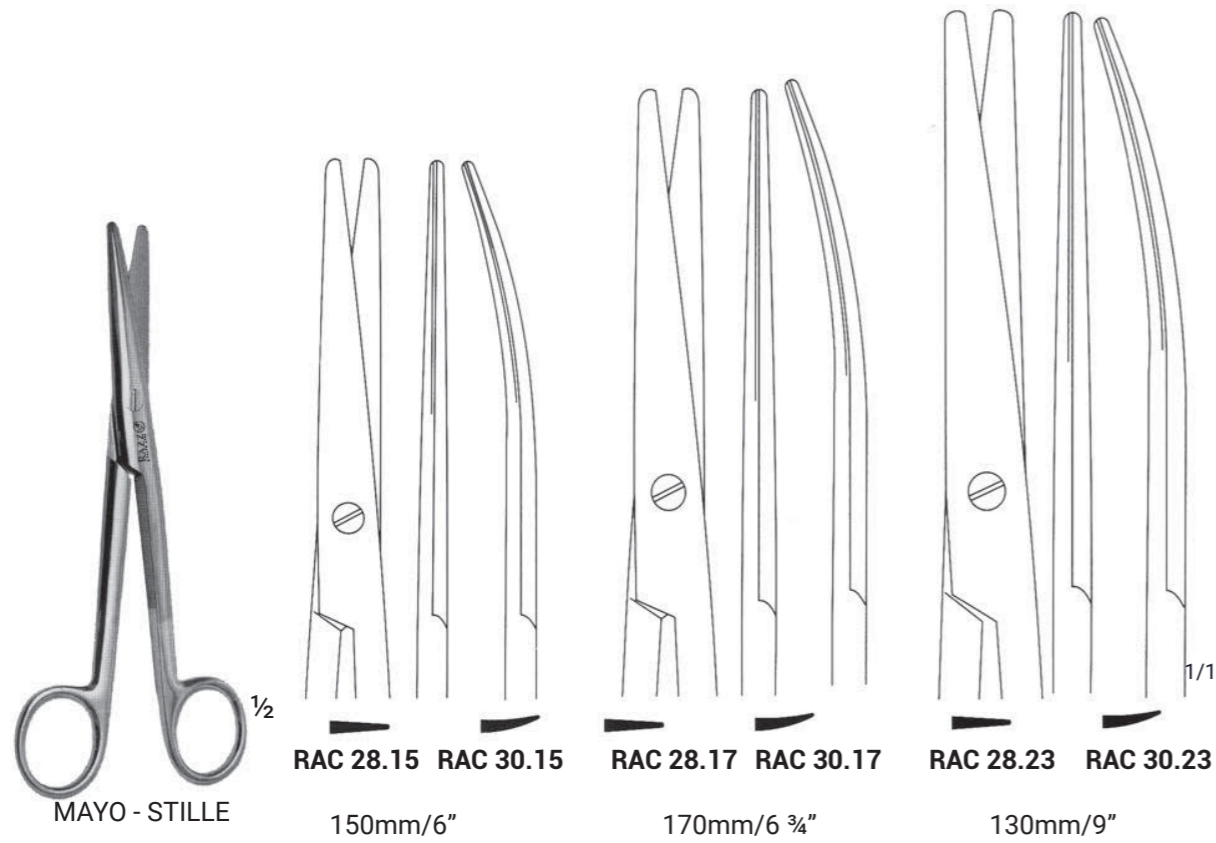

MAYO-HARRINGTON

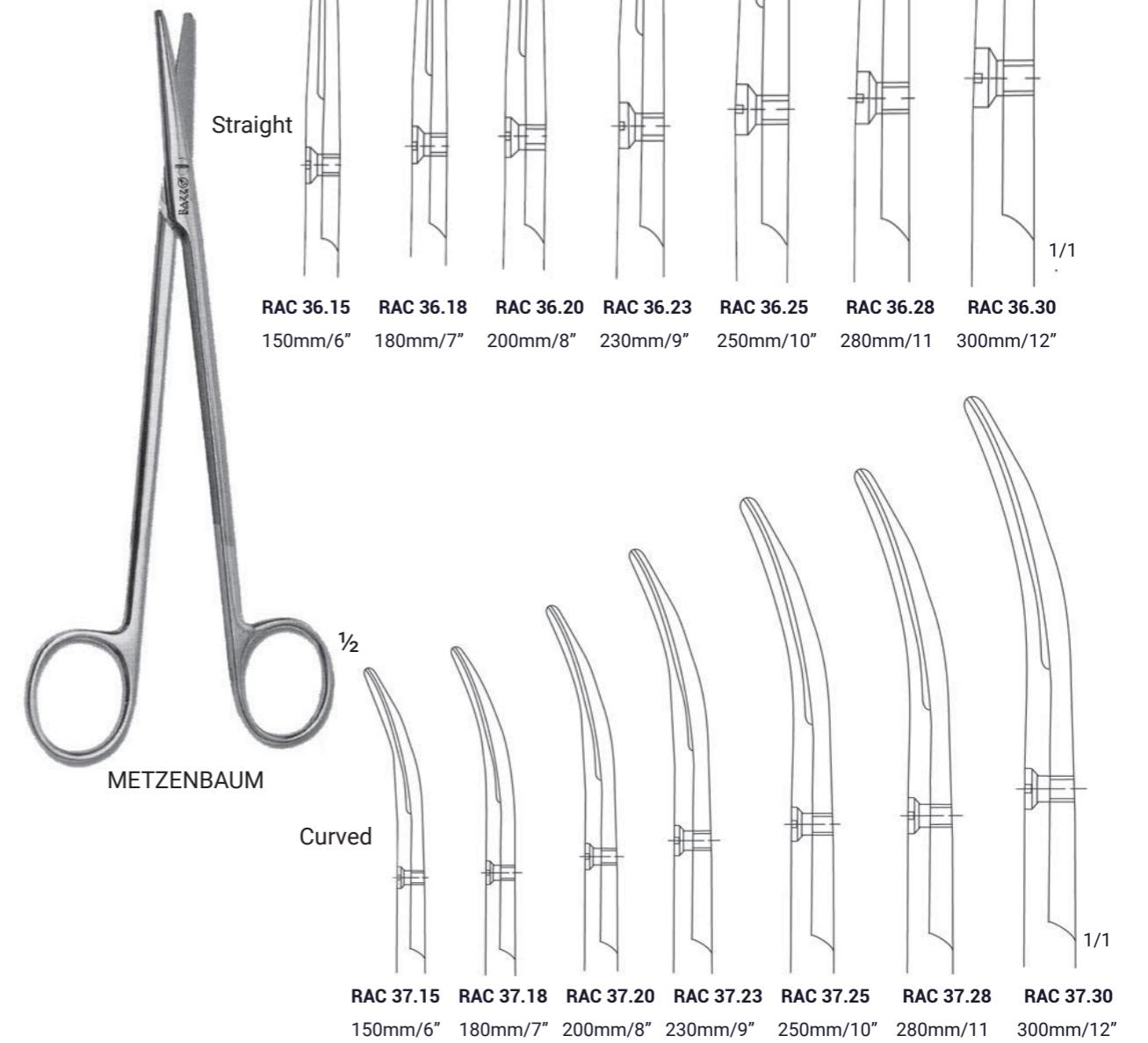
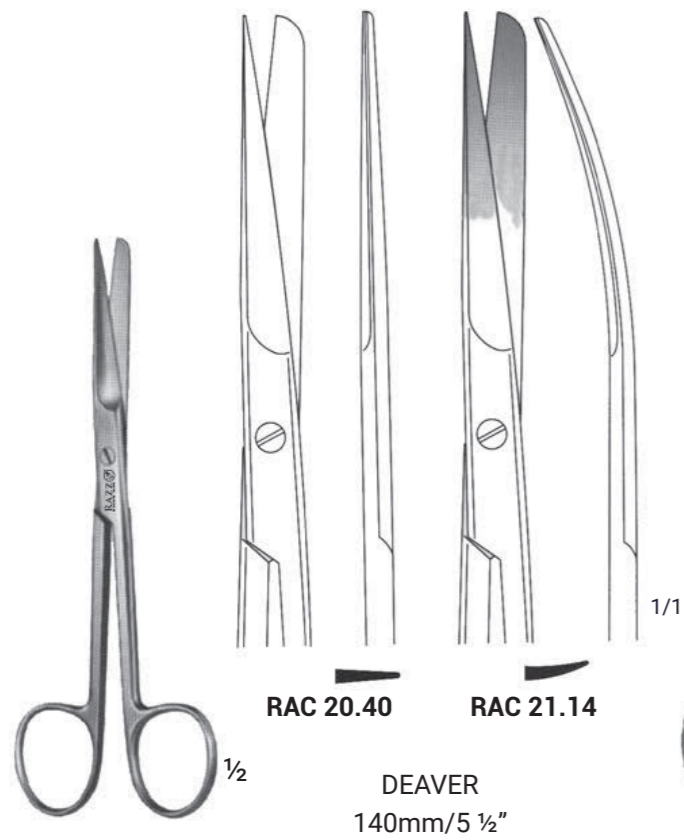
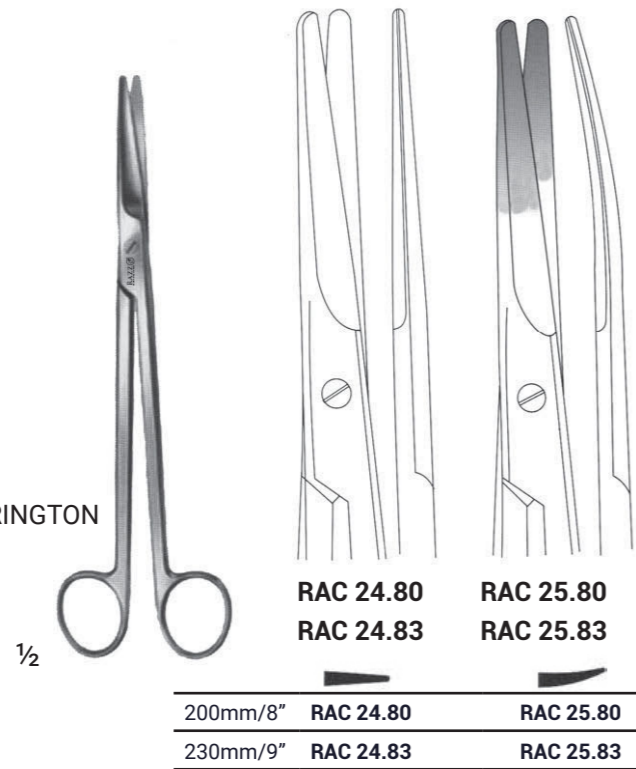

DISSECTING SCISSORS WITH T/C

DISSECTING SCISSORS WITH T/C

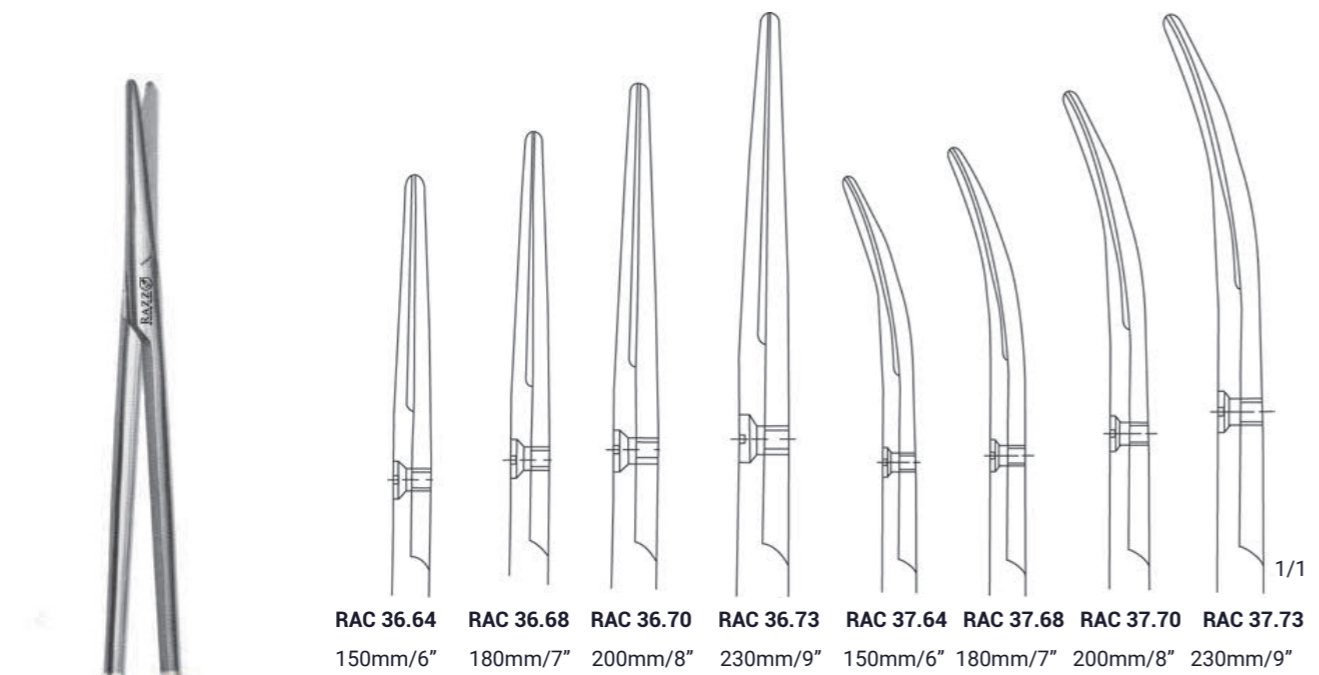

Straight

Curved



METZENBAUM T/C

METZENBAUM (NELSON) T/C

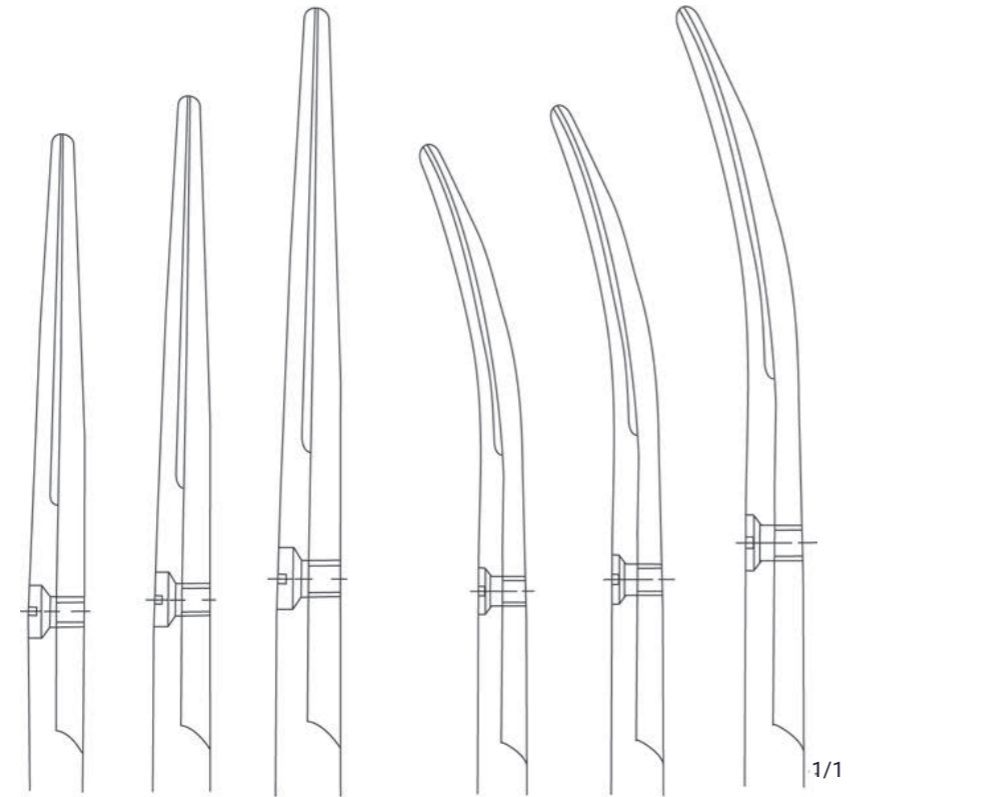

Straight

Curved

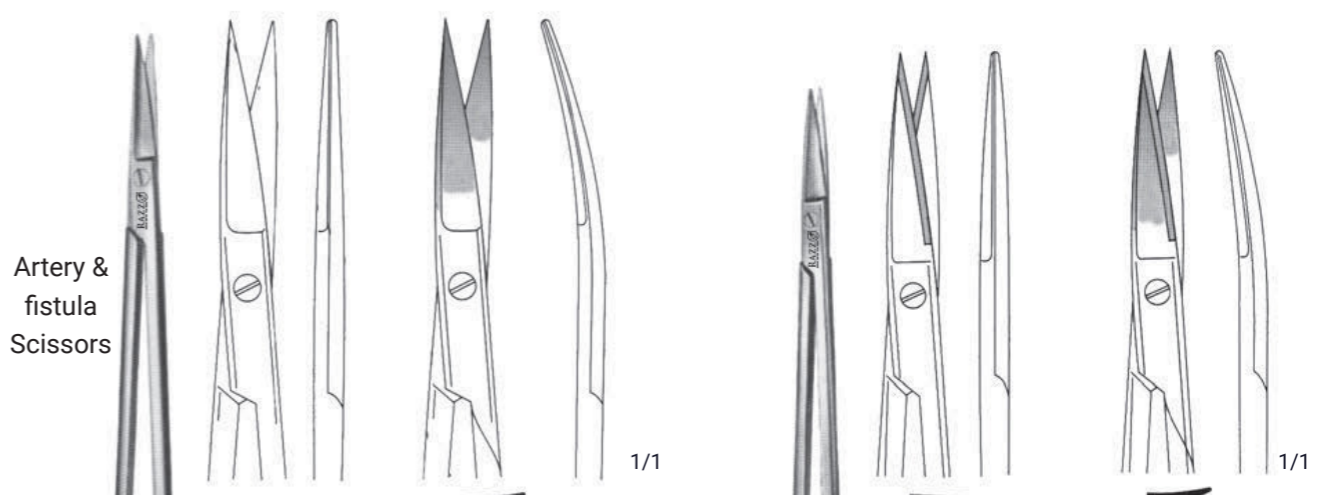

Artery & fistula Scissors

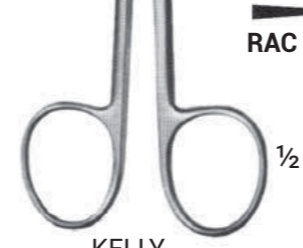

KELLY
160mm/6 1/4"

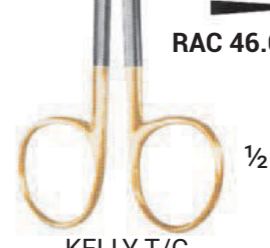

KELLY T/C
160mm/6 1/4"



TOENNIS ADSON
RAC 50.18
180mm/7 1/8"

TOENNIS ADSON T/C
RAC 50.68
180mm/7 1/8"

KILNER
RAC 59.13 - 130mm/5 1/8"
RAC 59.15 - 150mm/6"

KILNER T/C
RAC 59.63
130mm/5 1/8"

FINE DISSECTING SCISSORS WITH T/C

FINE OPERATING & PLASTIC SURGERY SCISSORS

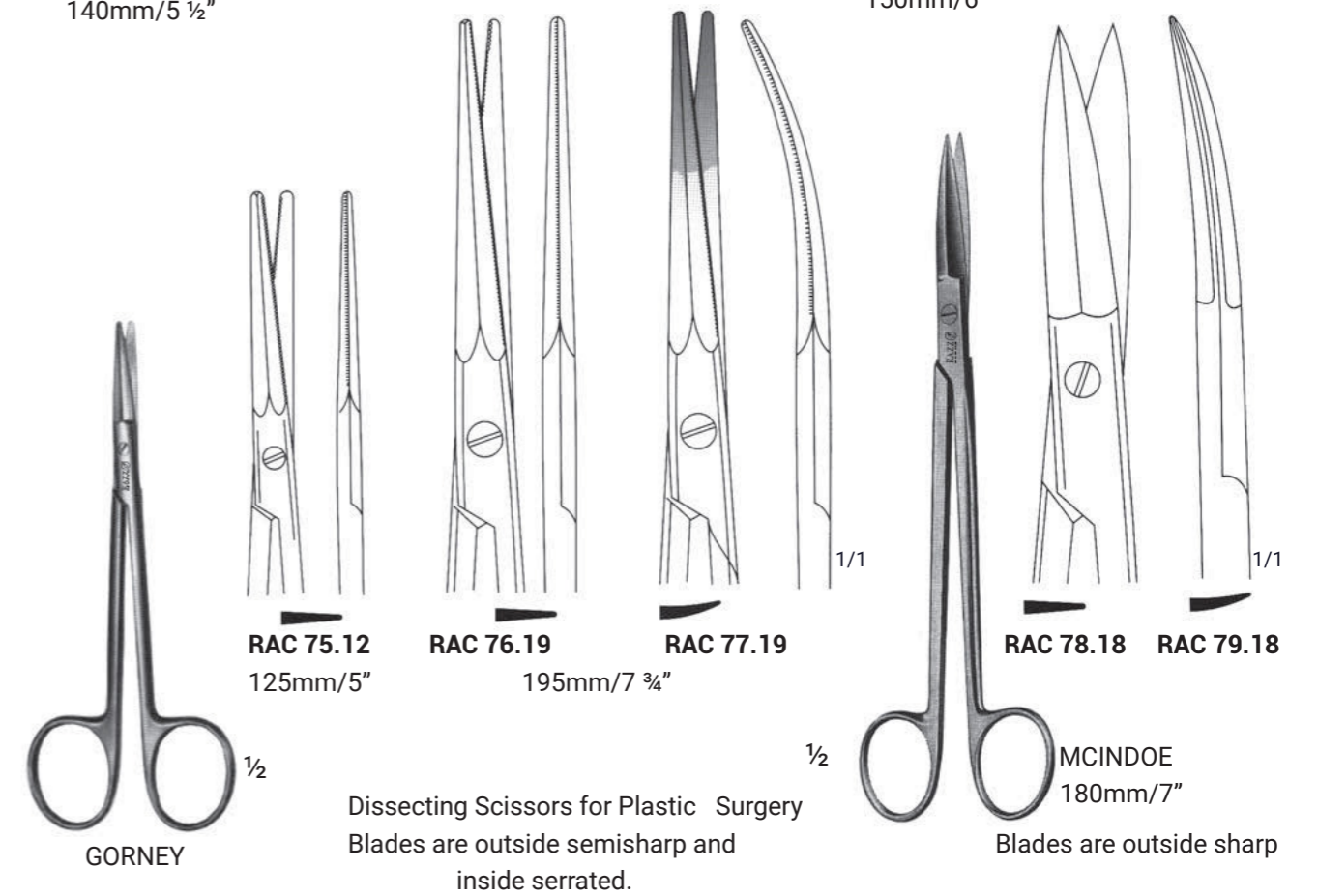
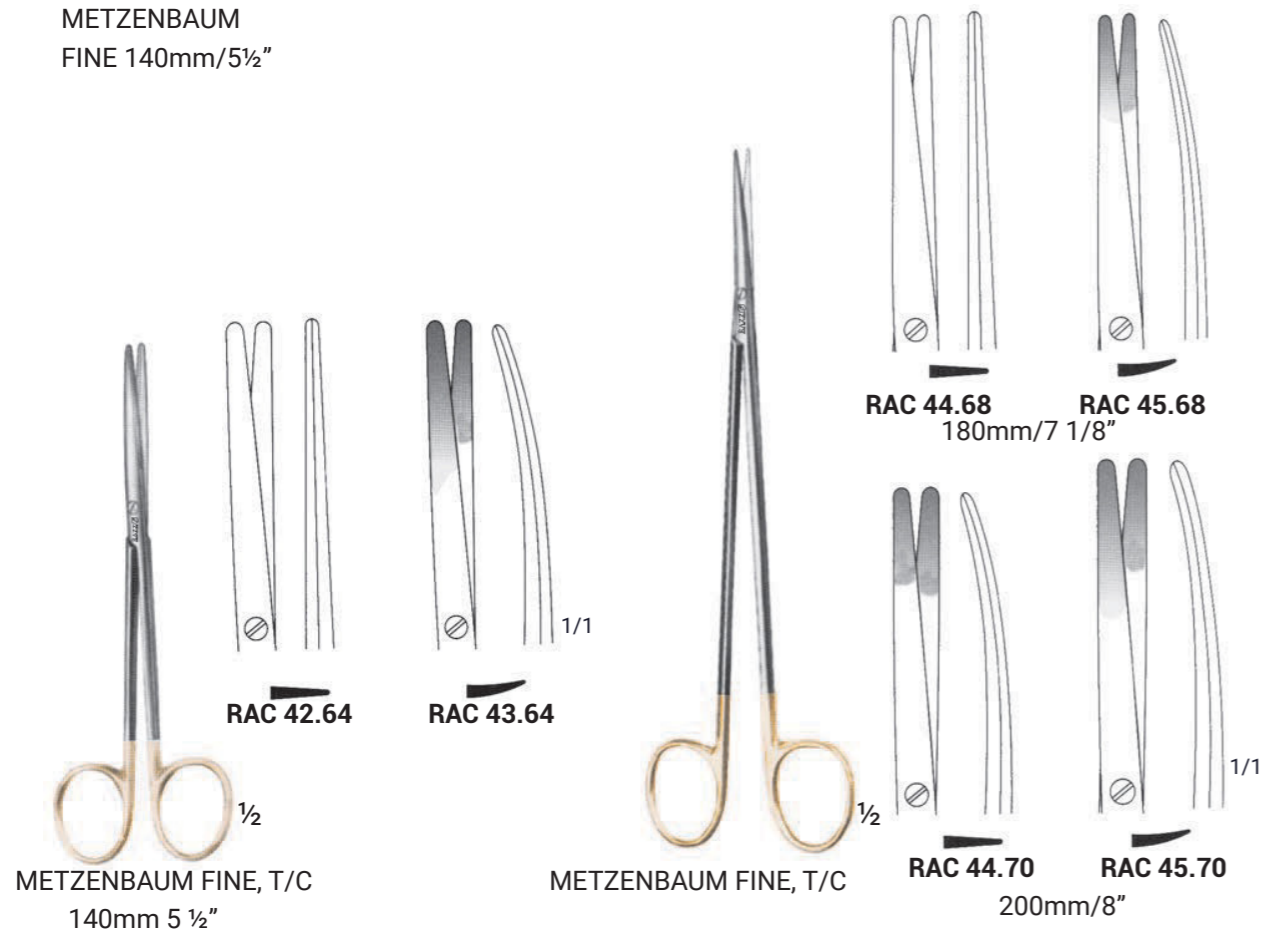
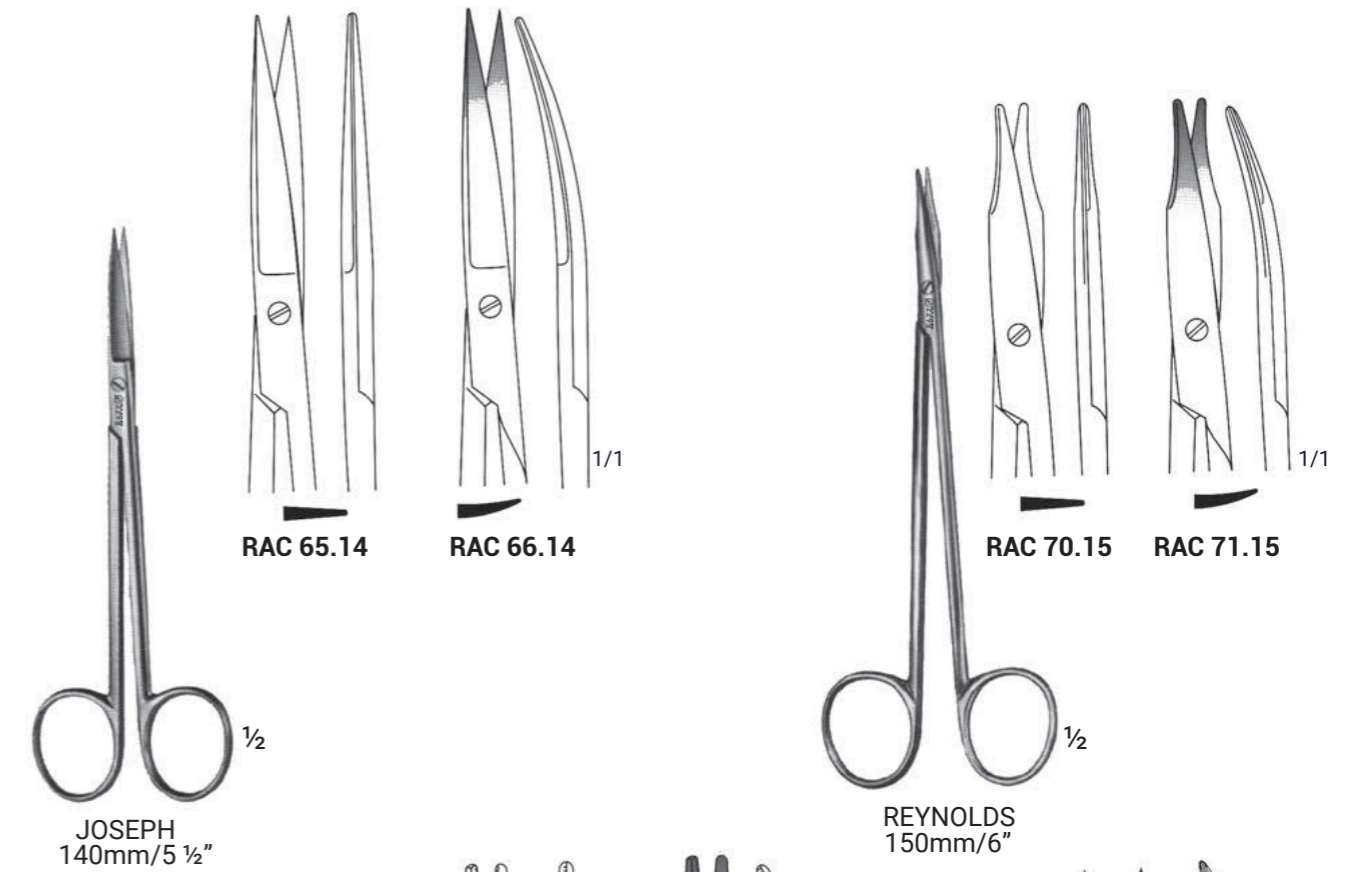
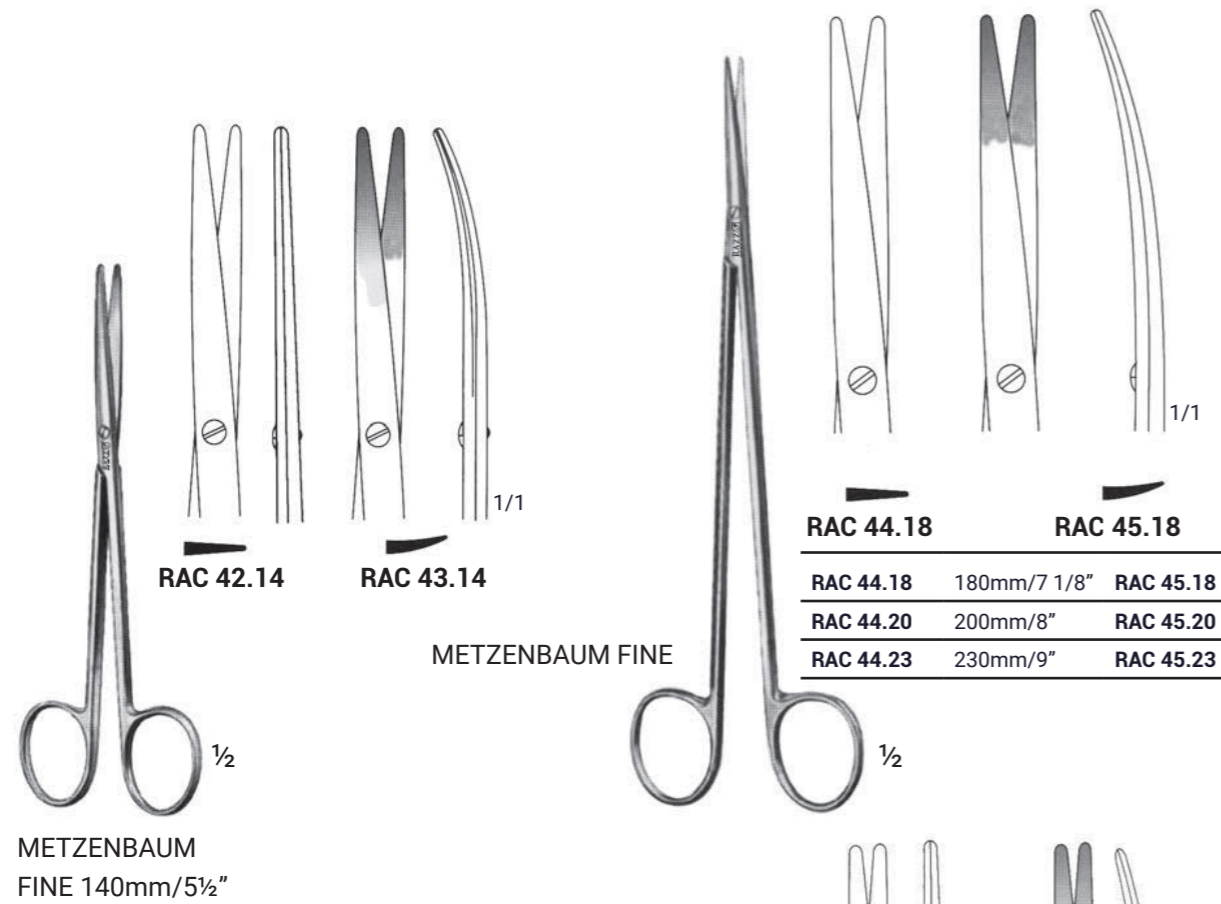



NEEDLE HOLDERS WITH T/C



NEEDLE HOLDERS

NEEDLE HOLDERS WITH T/C

NEEDLE HOLDERS WITH T/C

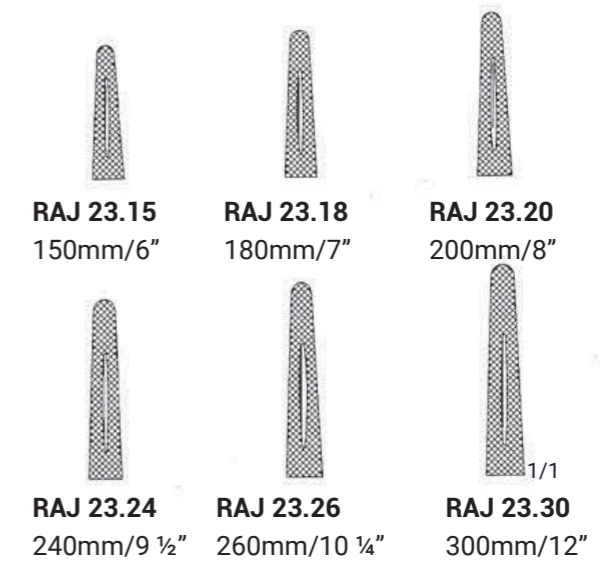

NEEDLE HOLDERS WITH T/C

NEEDLE HOLDERS WITH T/C



CRILE MURRAY
RAJ 32.45
150mm/6"



CRILE WOOD
RAJ 34.15
150mm/6"



CRILE WOOD T/C
RAJ 35.15
150mm/6"



MASSON T/C
RAJ 50.27
270mm/10 3/4"

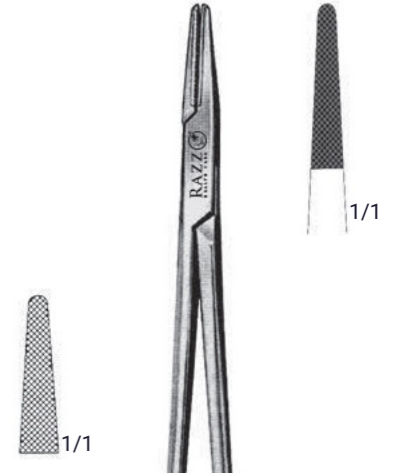

WANGENSTEEN, T/C
RAJ 52.28
280mm/11"



MASSON
RAJ 49.27
270mm/10 3/4"

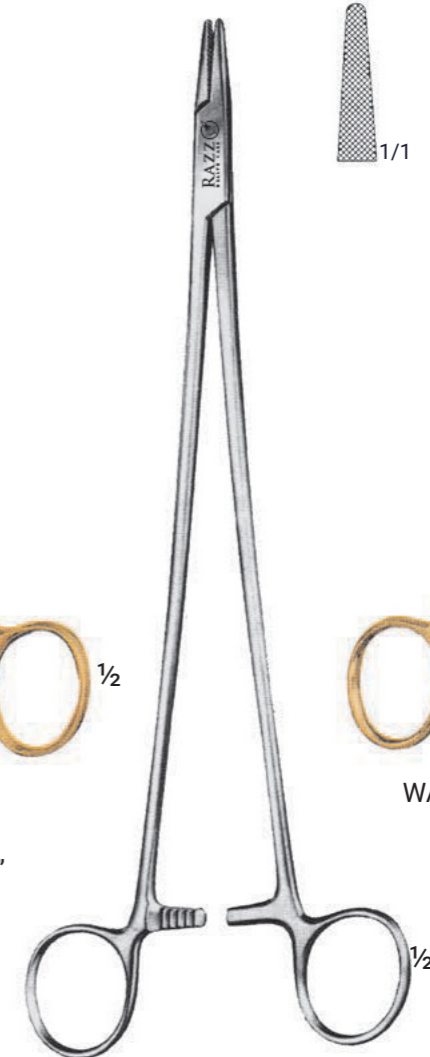

WANGENSTEEN
RAJ 51.28
280mm/11"

- RAJ 42.13 130mm/5"
- RAJ 42.15 150mm/6"
- RAJ 42.18 180mm/7"

- RAJ 42.20 200mm/8"
- RAJ 42.23 230mm/9"
- RAJ 42.26 250mm/10"



RYDER (FRENCH EYE) T/C

- RAJ 44.13 130mm/5"
- RAJ 44.15 150mm/6"

- RAJ 44.18 180mm/7"
- RAJ 44.20 200mm/8"

- RAJ 44.23 230mm/9"
- RAJ 44.26 260mm/10"



RYDER (VASCULAR) T/C

NEEDLE HOLDERS WITH T/C

NEEDLE HOLDERS WITH T/C

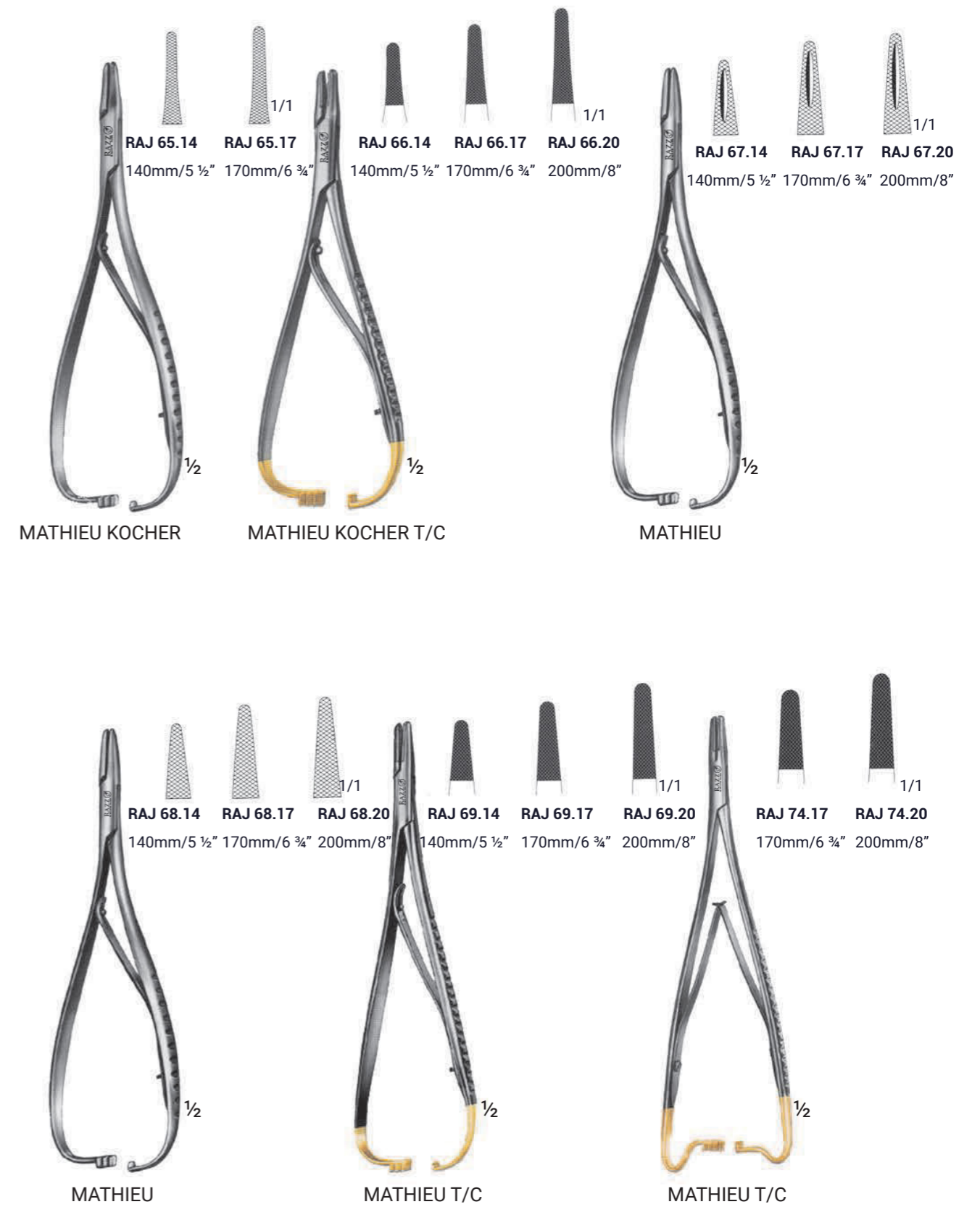
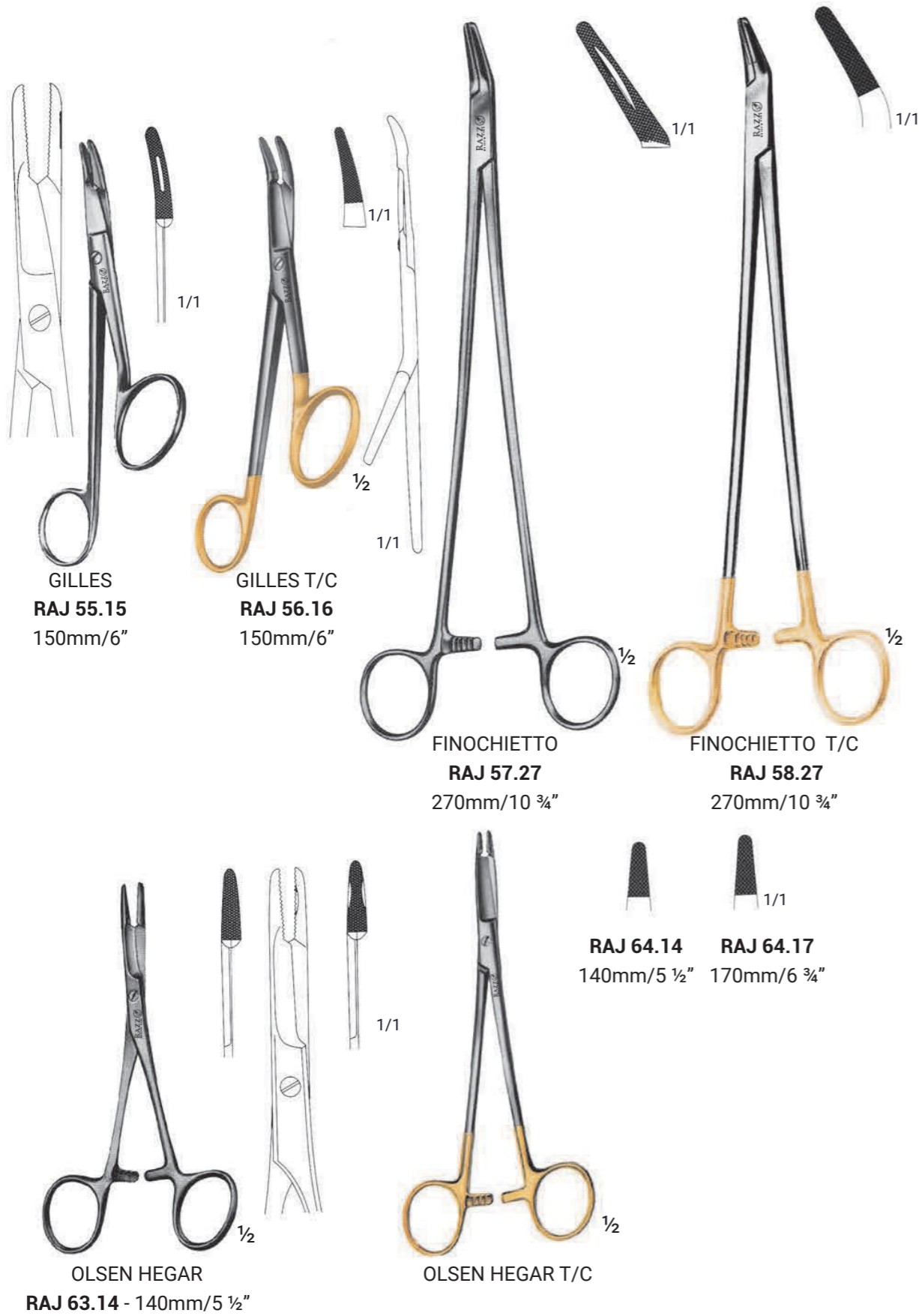

NEEDLE HOLDERS WITH T/C

MICRO NEEDLE HOLDERS WITH T/C



CASTROVIEJO - STANDARD
140mm/5 1/2"



CASTROVIEJO - STANDARD
140mm/5 1/2"



CASTROVIEJO (JACOBSON)

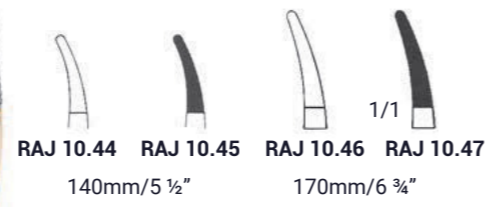
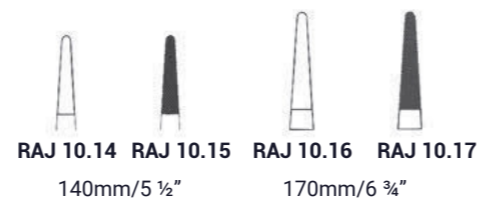

CASTROVIEJO - MICRO
140mm/5 1/2"



CASTROVIEJO - MICRO
140mm/5 1/2"



CASTROVIEJO - STANDARD
140mm/5 1/2"



RAJ 76.18

RAJ 78.18



RAJ 77.18

RAJ 79.18

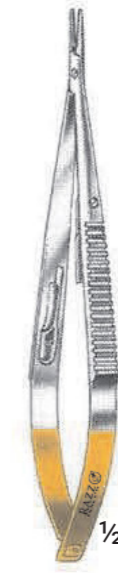

CASTROVIEJO - STANDARD
140mm/5 1/2"



RAJ 58.01



RAJ 58.02

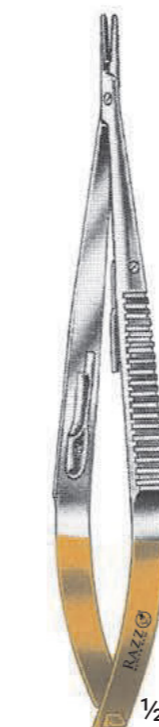

CASTROVIEJO - MICRO
180mm/7"

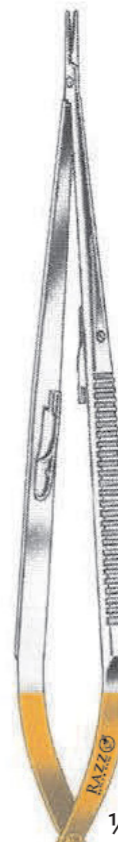

CASTROVIEJO - MICRO
210mm/8 1/4"

MICRO NEEDLE HOLDERS WITH T/C

MICRO NEEDLE HOLDERS WITH PEN TYPE HANDLE

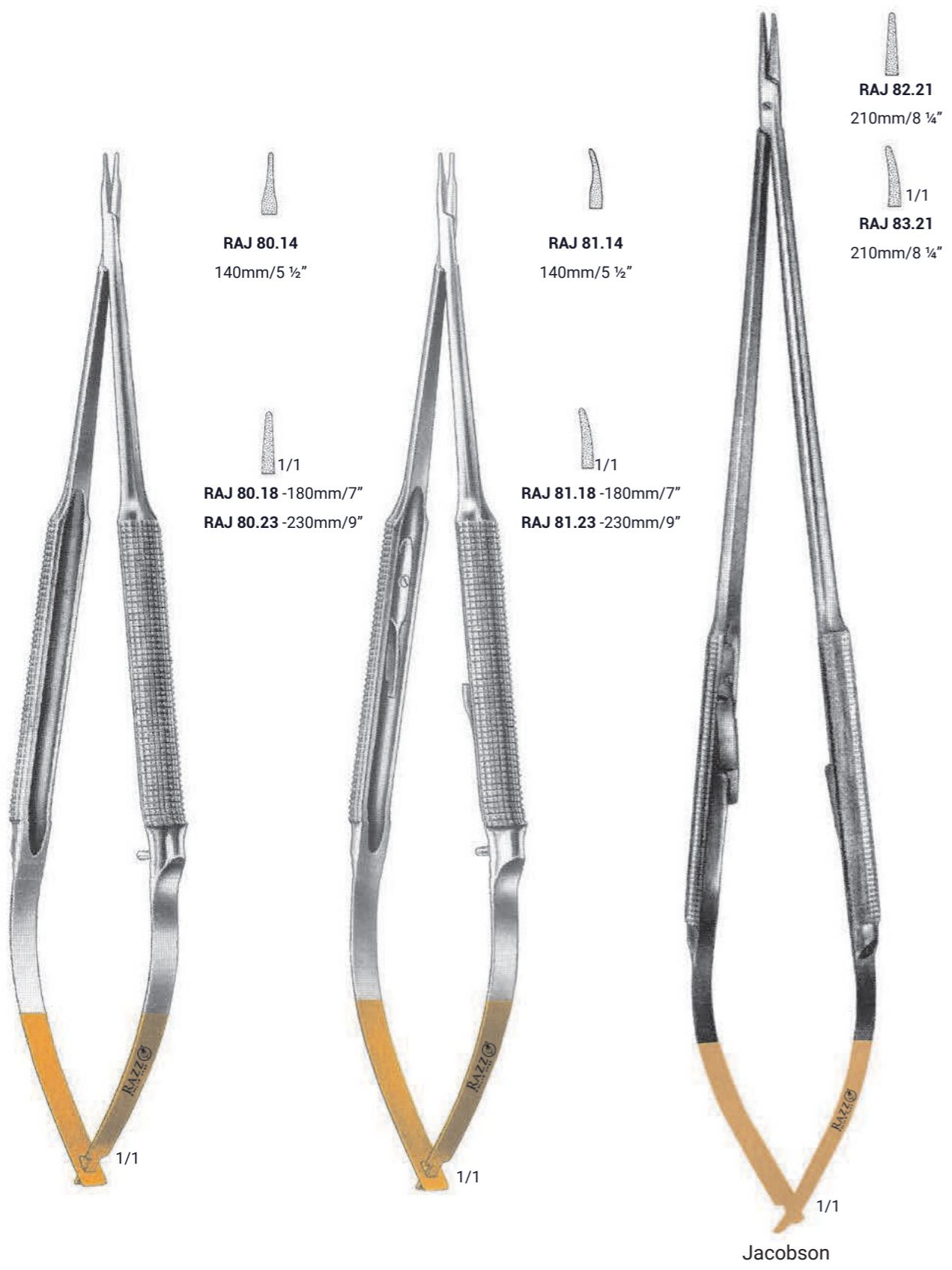



DESCHAMPS - BABY
RSA 01.20 - RSA 01.21
200mm/8"



DESCHAMPS - BABY
RSA 01.22 - RSA 01.23
200mm/8"

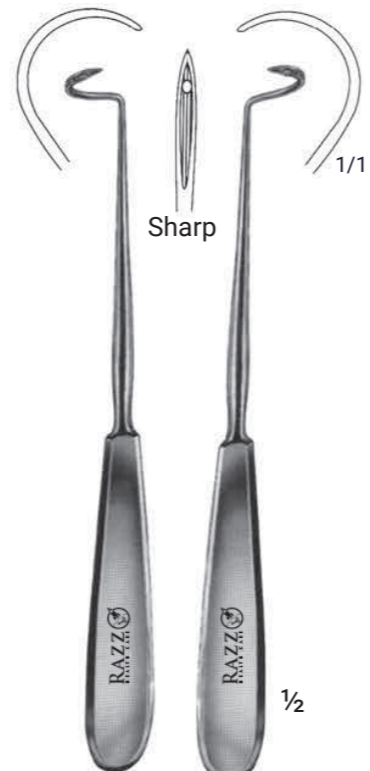

DESCHAMPS - BABY
RSA 02.20 - RSA 02.21
200mm/8"

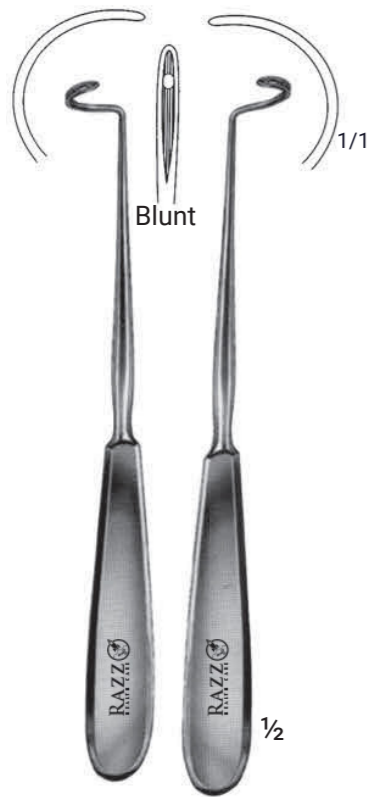

DESCHAMPS
RSA 02.22 - RSA 02.25
200mm/8"

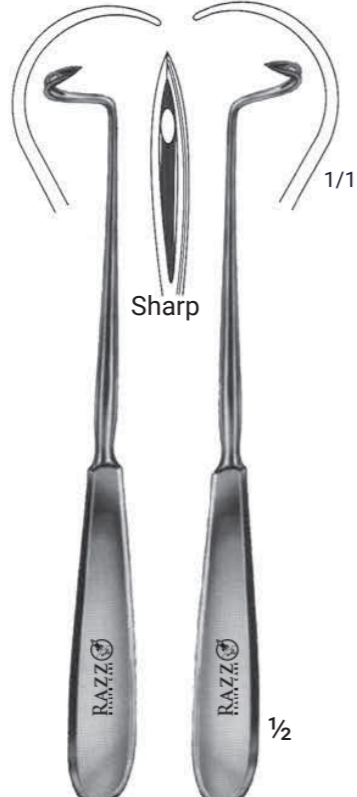

DESCHAMPS
RSA 03.20 - RSA 03.21
200mm/8"

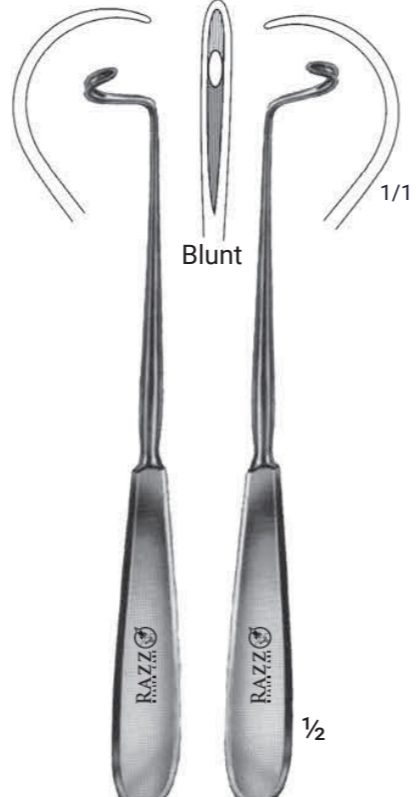

DESCHAMPS
RSA 03.22 - RSA 03.23
200mm/8"

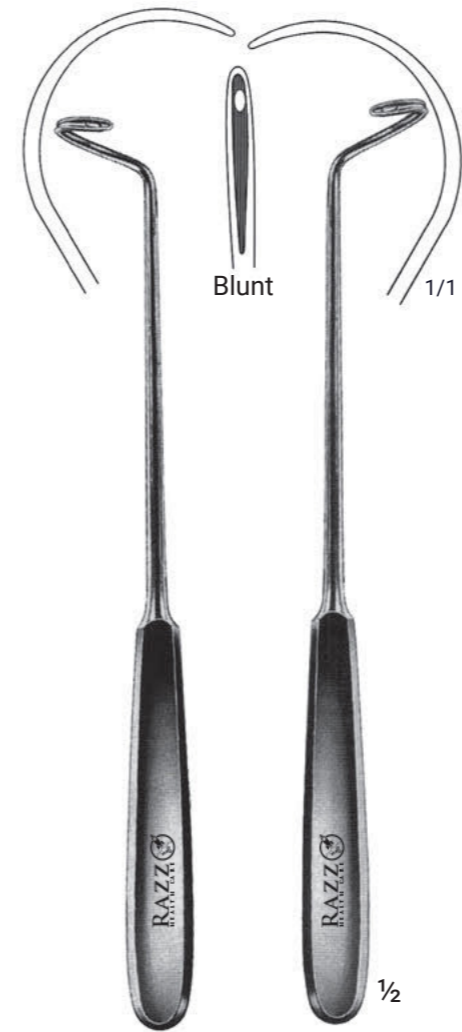

DESCHAMPS
RSA 03.24 - RSA 03.25
240mm/9 1/2"

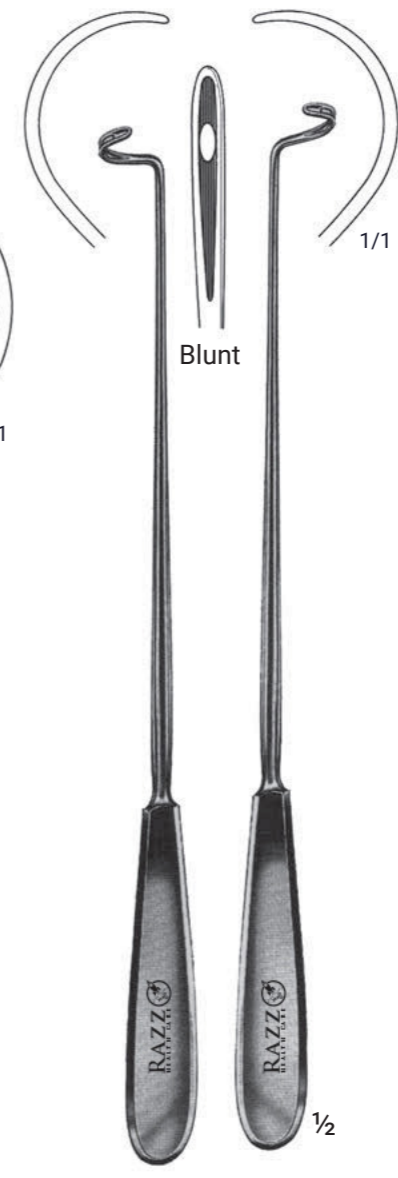

DESCHAMPS
RSA 04.28 - RSA 04.29
280mm/11"

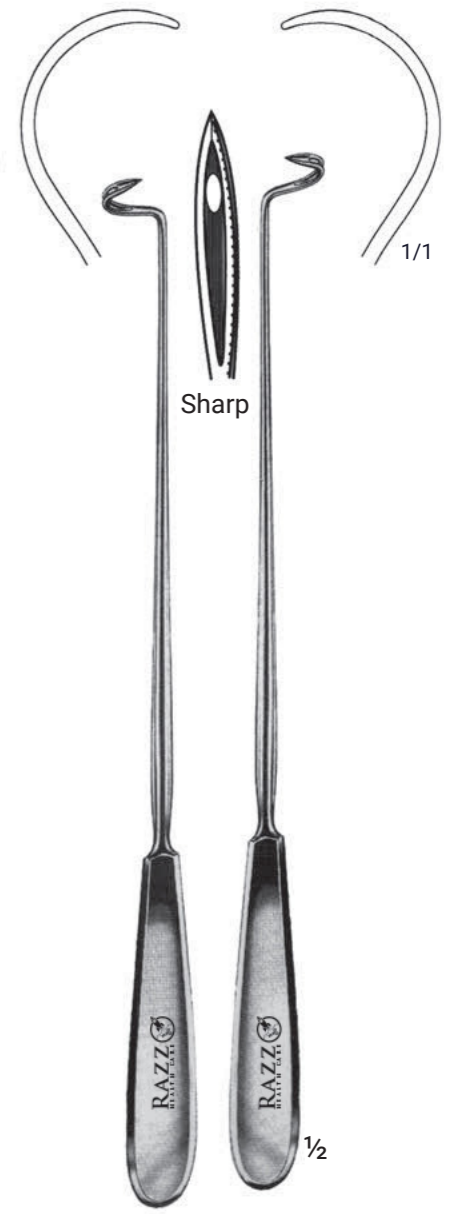

DESCHAMPS
RSA 05.28 - RSA 05.29
280mm/11"



RETRACTORS

RETRACTORS & VEIN HOOKS

SEN MILLER
160mm/6 1/4"

RAY 01.16
7 x 8.5mm
Sharp

RAY 02.16
7 x 8.5mm
Blunt

RAGNELL - DAVIS RAY 05.16
160mm/6 1/4"

RAY 03.08
8mm

RAY 03.10
10mm

RAY 03.12
12mm

RAY 03.14
14mm

RAY 03.16
16mm

RAY 03.18
18mm

RAY 03.28
8mm

RAY 03.30
10mm

RAY 03.32
12mm

RAY 03.34
14mm

RAY 03.36
16mm

RAY 03.38
18mm

CUSHING
200mm/8"

CUSHING
240mm/9 1/2"

HOOKS & RETRACTORS

HOOKS & RETRACTORS

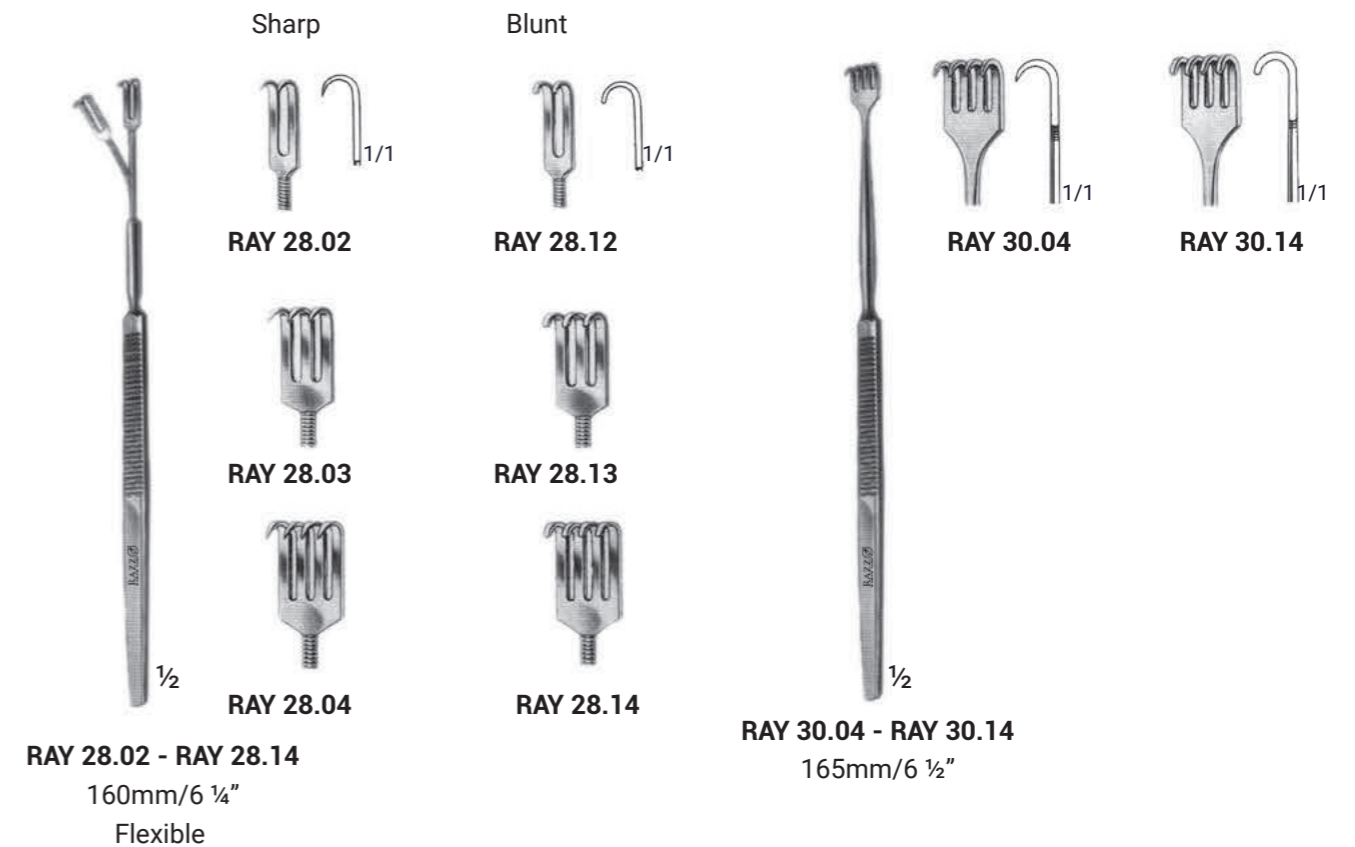
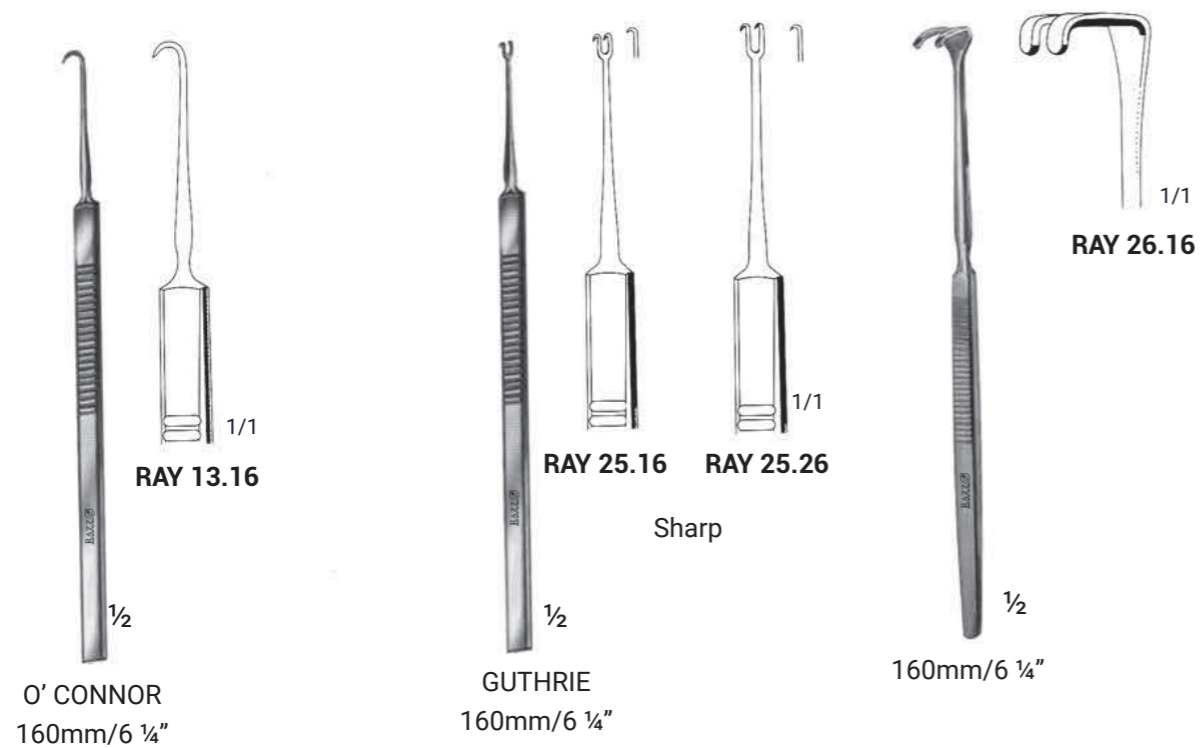
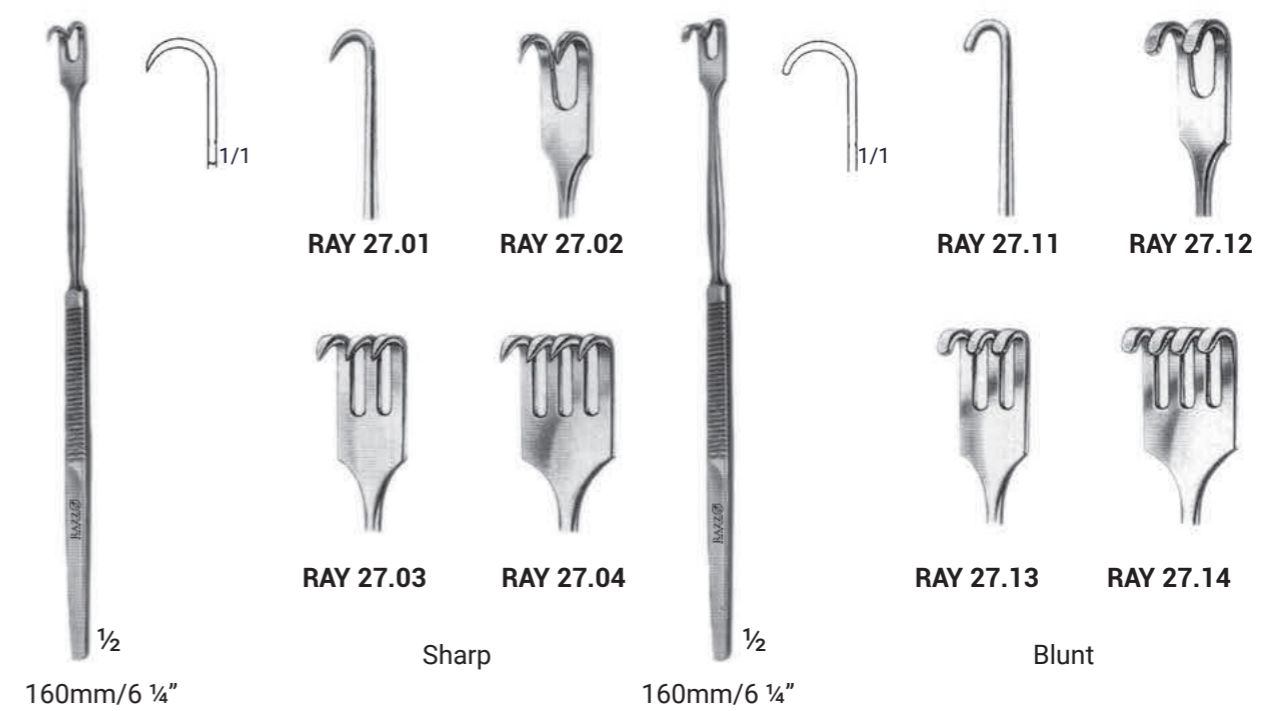
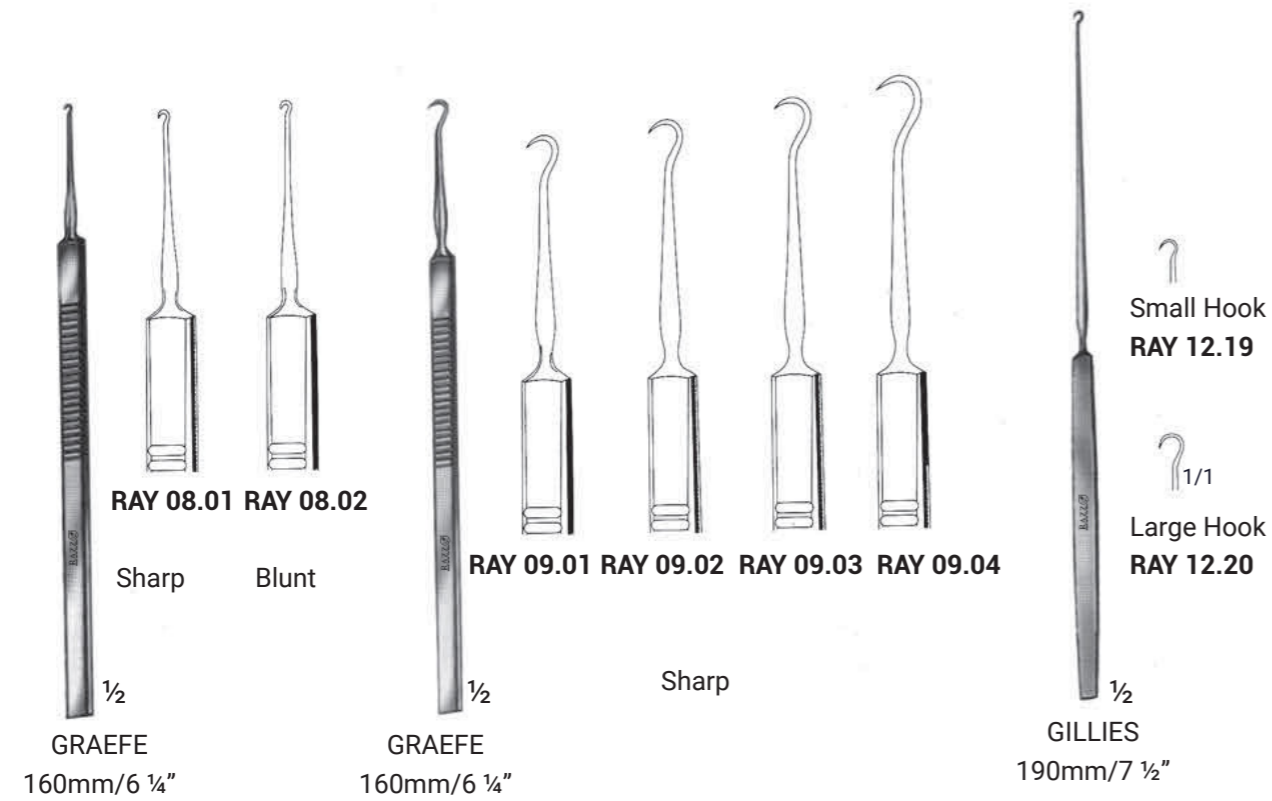

HOOKS & RETRACTORS

ABDOMINAL SPATULAS & RIBBON RETRACTORS

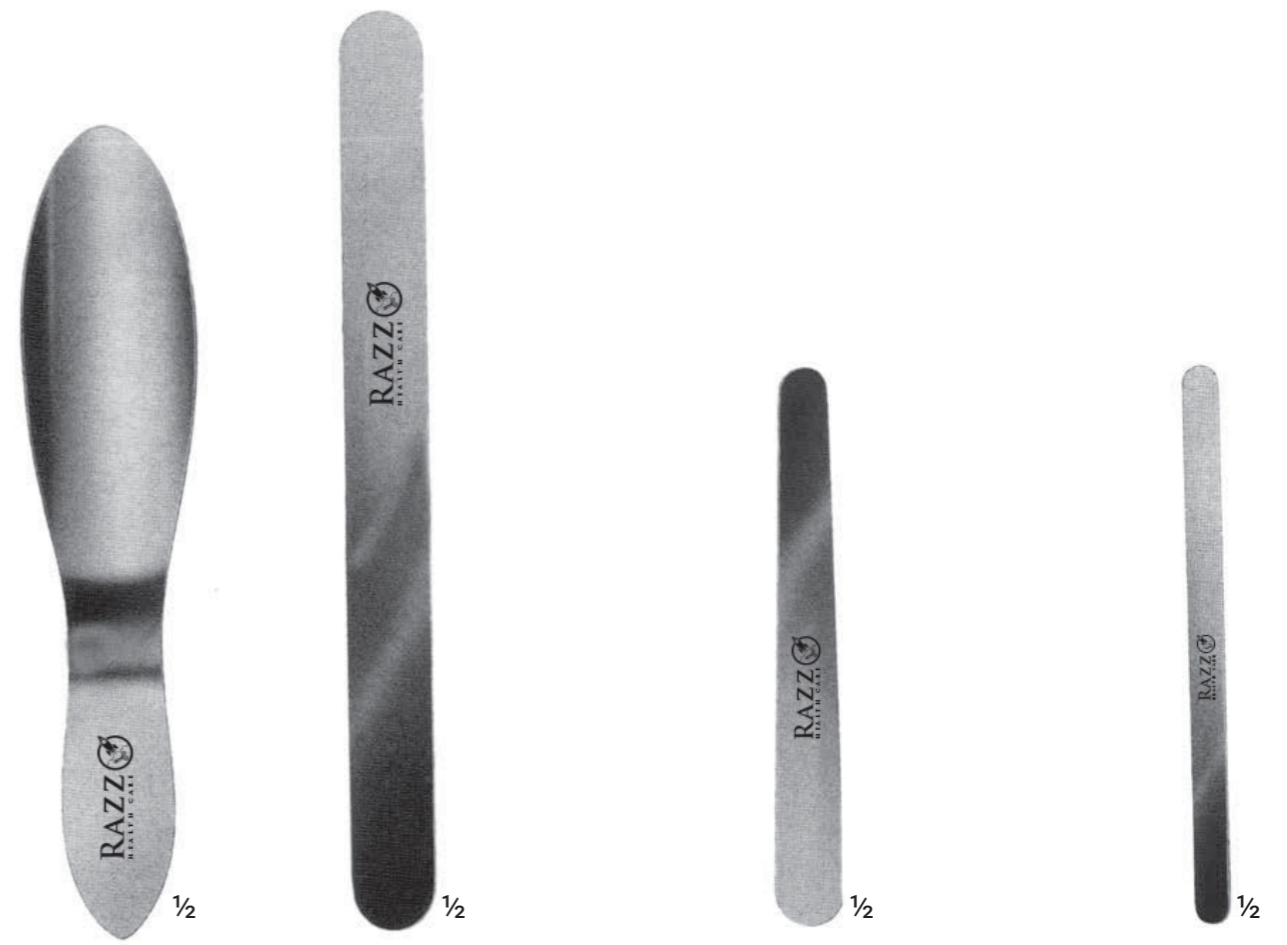
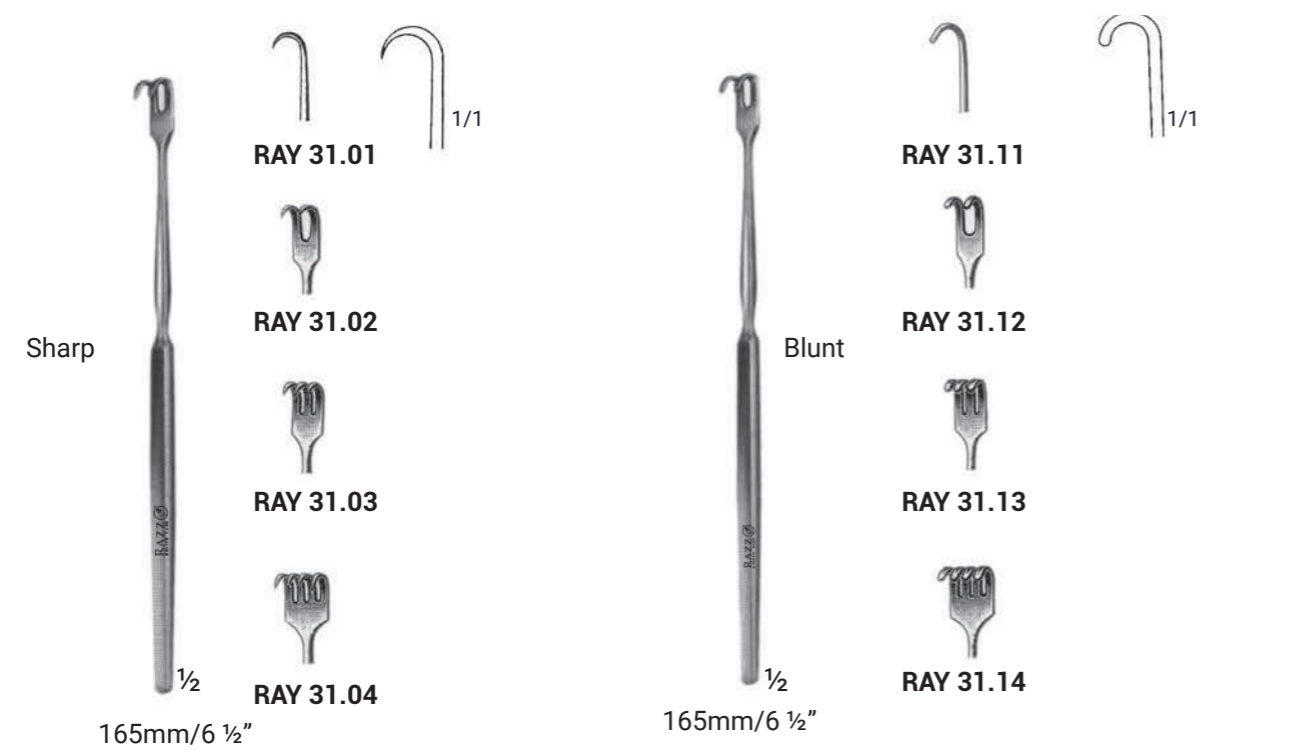



FARABEUZ
Set of 2
120mm/4 3/4"

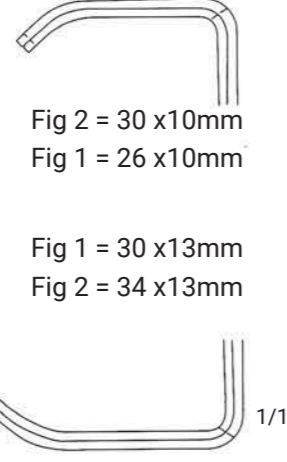

Fig 2 = 30 x 10mm
Fig 1 = 26 x 10mm

Fig 1 = 30 x 13mm
Fig 2 = 34 x 13mm

RAY 46 .12



FARABEUZ
Set of 2
150mm/6"

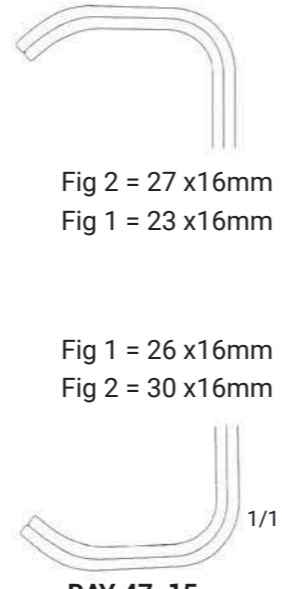

Fig 2 = 27 x 16mm
Fig 1 = 23 x 16mm

Fig 1 = 26 x 16mm
Fig 2 = 30 x 16mm

RAY 47 .15



PARKER
18 x 15mm, 18 x 15mm
150mm/6"
RAY 48.30

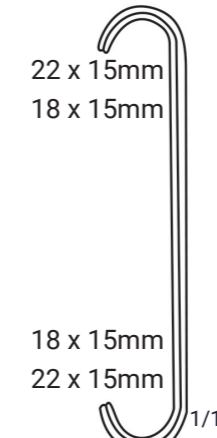

22 x 15mm
18 x 15mm

18 x 15mm
22 x 15mm

RAY 48.32
(Set of 2)

22 x 15mm, 22 x 15mm
150mm/6"
RAY 48.31



PARKER - LANGENBECK
Set of 2
210mm/8 1/4"

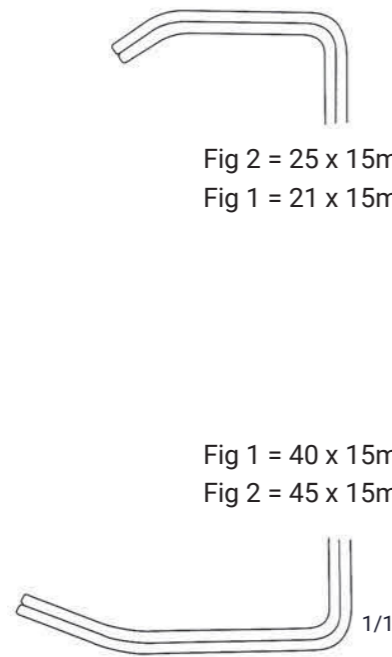

Fig 2 = 25 x 15mm
Fig 1 = 21 x 15mm

Fig 1 = 40 x 15mm
Fig 2 = 45 x 15mm

RAY 48 .21



RAY 49 .01 - Fig 1 = 150mm/6"
RAY 49 .02 - Fig 2 = 160mm/6 1/4"
RAY 49 .03 - Fig 3 = 170mm/6 3/4"
(RAY 49 .10 Set of 3)

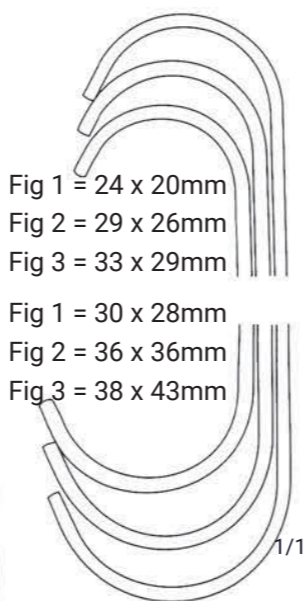
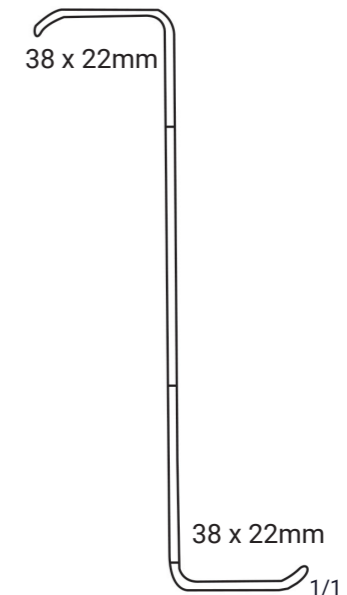

Fig 1 = 24 x 20mm
Fig 2 = 29 x 26mm
Fig 3 = 33 x 29mm

Fig 1 = 30 x 28mm
Fig 2 = 36 x 36mm
Fig 3 = 38 x 43mm



CZERNY
180mm/7"
RAY 48.25



38 x 22mm

38 x 22mm

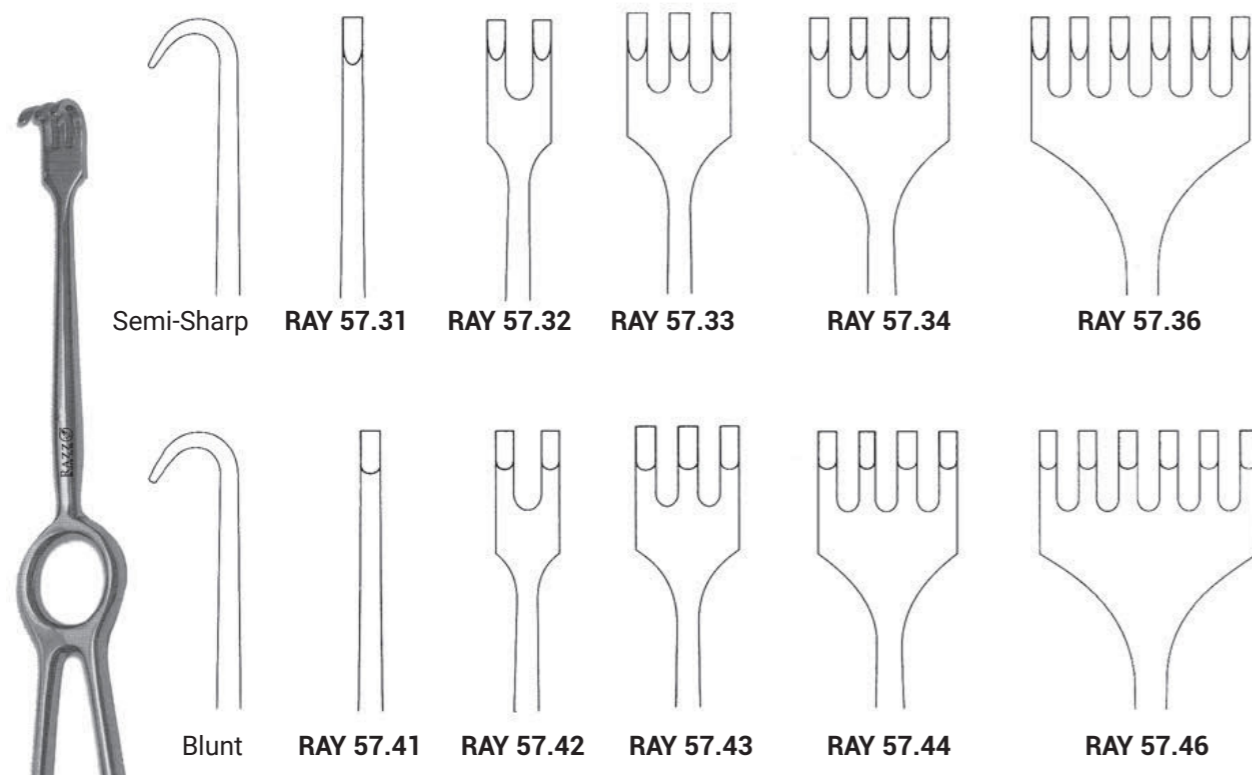
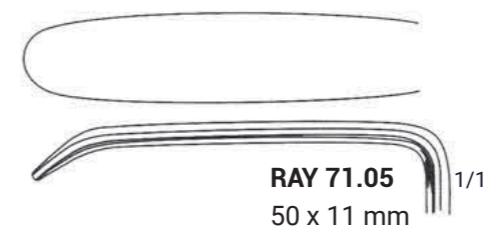
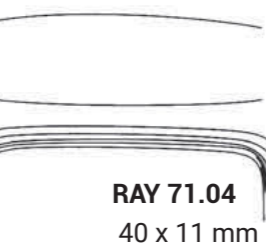
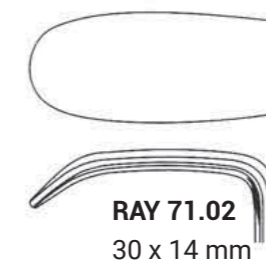
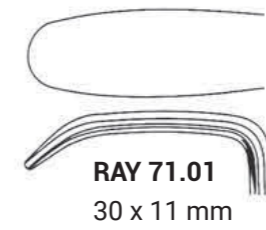
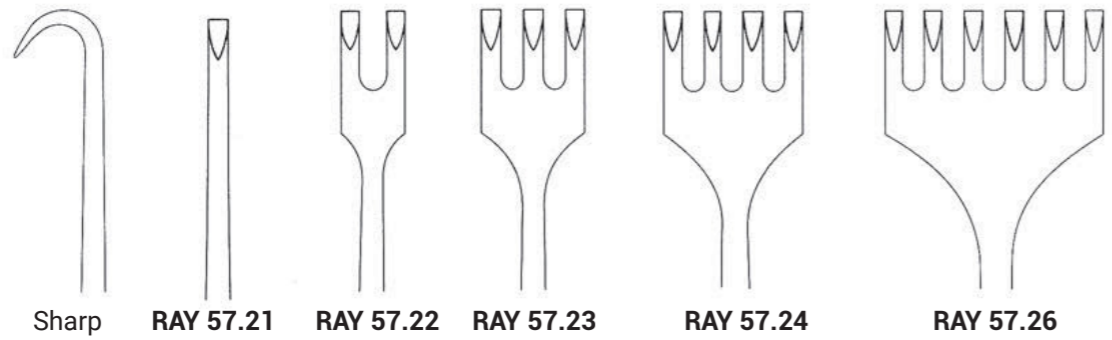

VOLKMANN
(KOCHER)
Bone Hook



RETRACTORS

RETRACTORS



LANGENBECK - KOCHER
210mm/8 1/4"

1/1

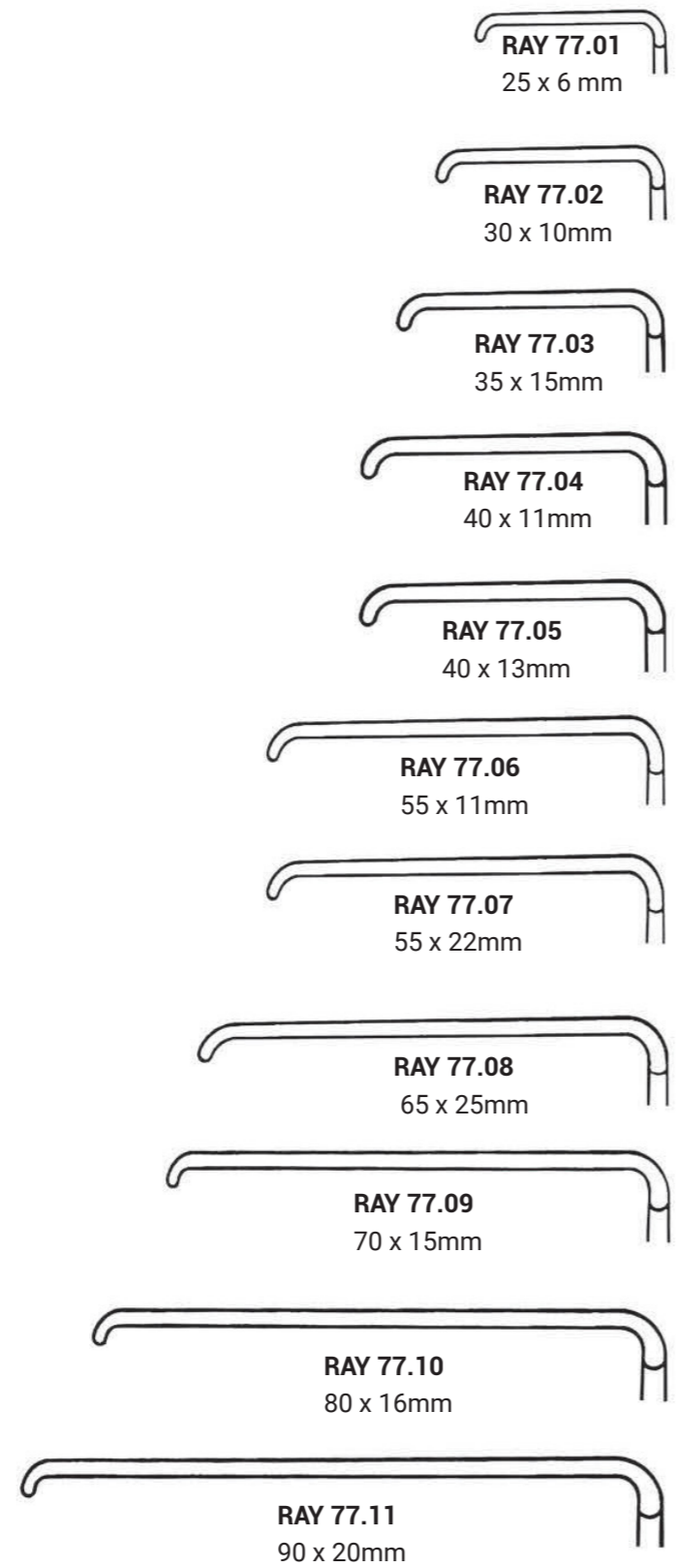

RAY 77.01
25 x 6 mm

RAY 77.02
30 x 10mm

RAY 77.03
35 x 15mm

RAY 77.04
40 x 11mm

RAY 77.05
40 x 13mm

RAY 77.06
55 x 11mm

RAY 77.07
55 x 22mm

RAY 77.08
65 x 25mm

RAY 77.09
70 x 15mm

RAY 77.10
80 x 16mm

RAY 77.11
90 x 20mm



JOLLSTHYROID
230mm/9"
RAY 48.40



LANDONS VAGINAL
200mm/8"
RAY 48.50

1/2



JOLLSTWINCLAMP
(FRIEDMAN)
155mm/6 1/4"
RAY 48.60

1/2



MORRIS
230mm/9"
RAY 48.40-48.65

30 x 40mm
RAY 48.70

35 x 50mm
RAY 48.75

65 x 65mm
RAY 48.80

1/2

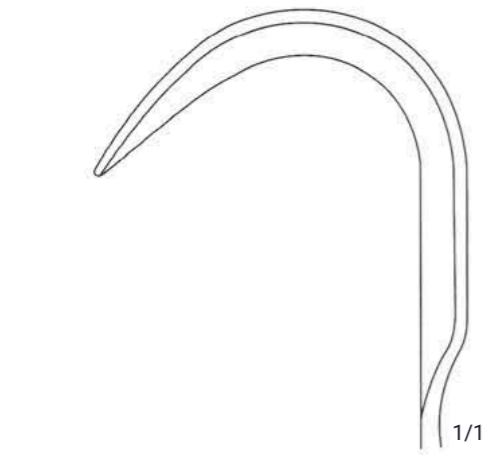

1/1



DOYEN'S
230mm/9"
1/2

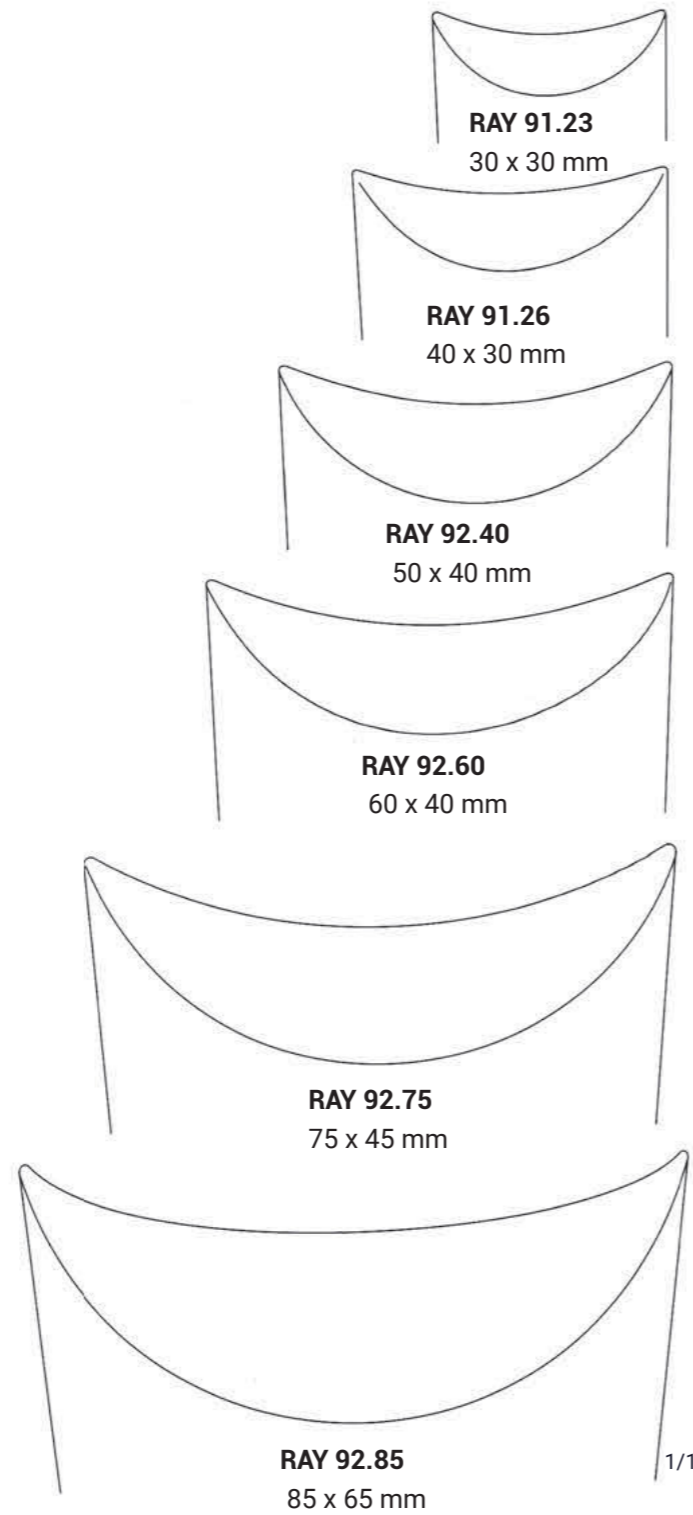

RAY 91.23
30 x 30 mm

RAY 91.26
40 x 30 mm

RAY 92.40
50 x 40 mm

RAY 92.60
60 x 40 mm

RAY 92.75
75 x 45 mm

RAY 92.85
85 x 65 mm

1/1



ISRAEL
250mm/10"
1/2

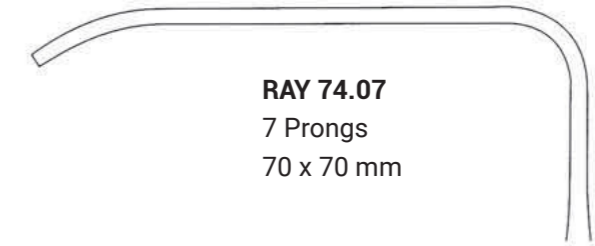

RAY 74.07
7 Prongs
70 x 70 mm

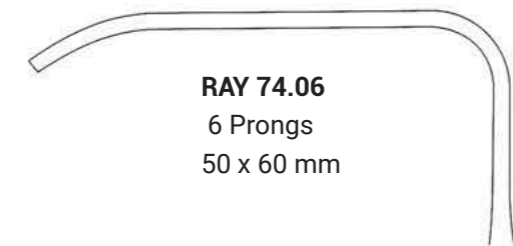

RAY 74.06
6 Prongs
50 x 60 mm

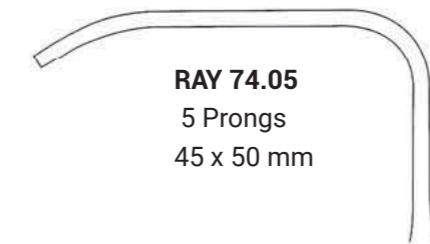

RAY 74.05
5 Prongs
45 x 50 mm



RAY 74.22
4 Prongs
40 x 40 mm

1/1

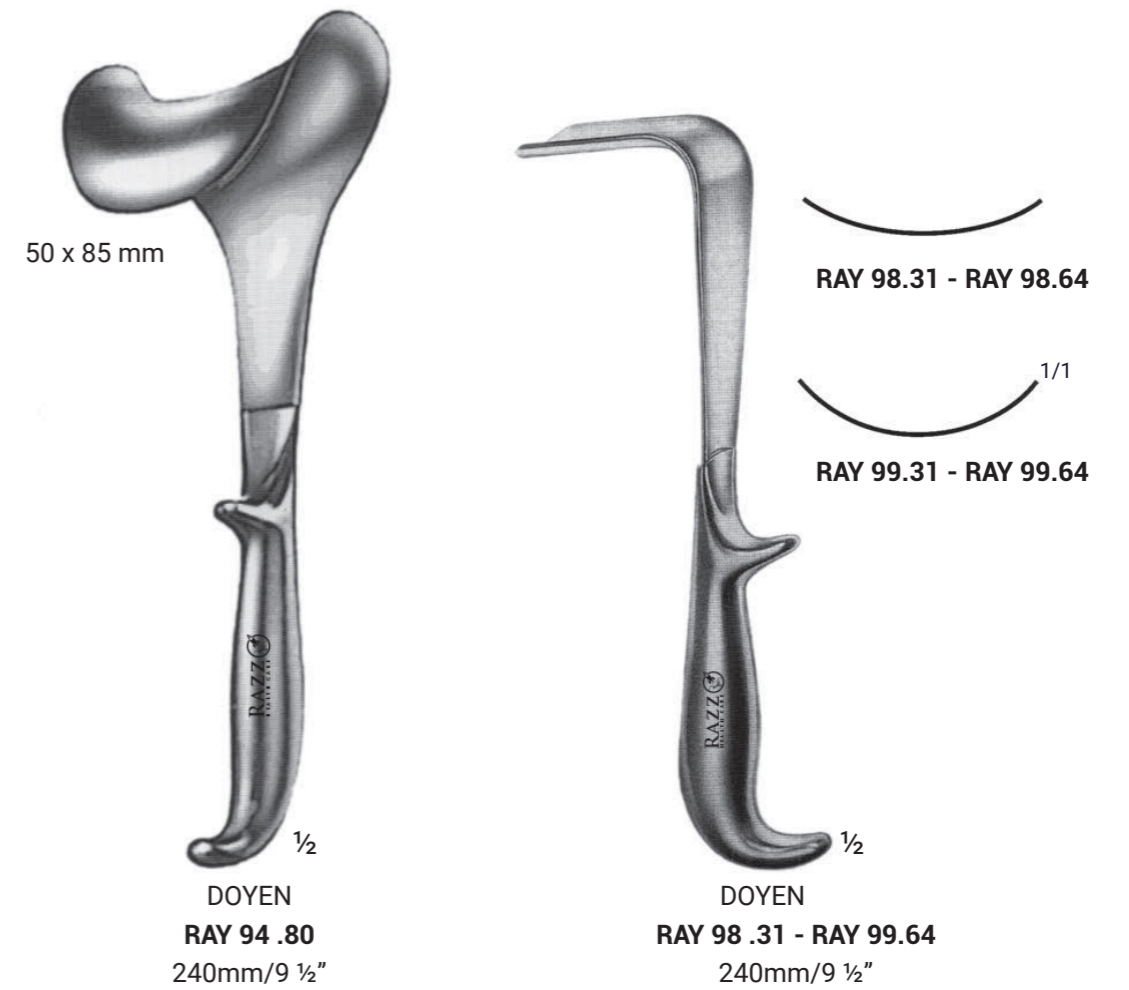
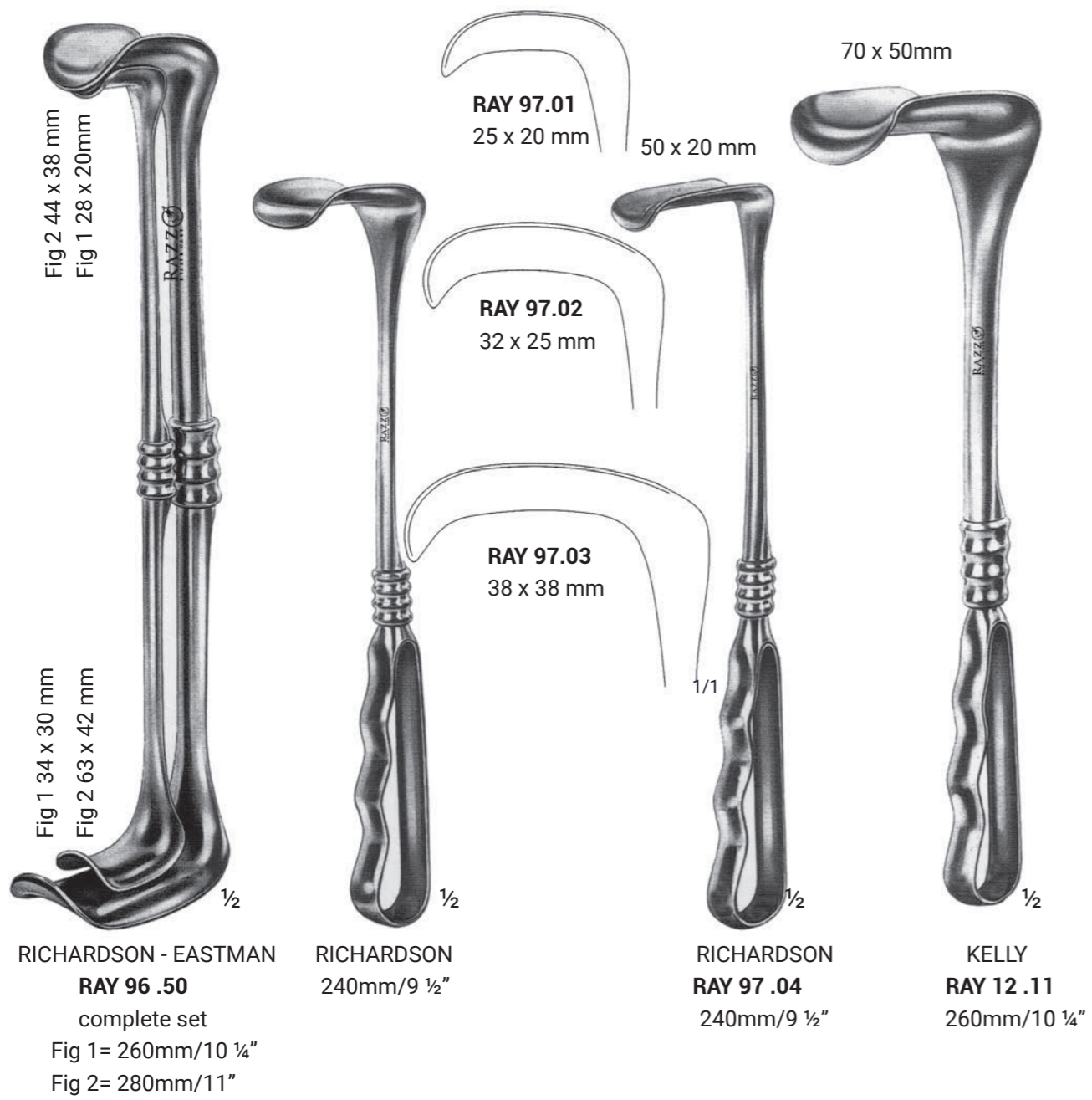

A mm	B mm	Slightly Concave	Medium Hollow
55	35	RAY 98.31	RAY 99.31
85	35	RAY 98.32	RAY 99.32
115	35	RAY 98.33	RAY 99.33
55	45	RAY 98.41	RAY 99.41
85	45	RAY 98.42	RAY 99.42
115	45	RAY 98.43	RAY 99.43
160	45	RAY 98.44	RAY 99.44
55	60	RAY 98.61	RAY 99.61
85	60	RAY 98.62	RAY 99.62
115	60	RAY 98.63	RAY 99.63
160	60	RAY 98.64	RAY 99.64

RETRACTORS

DEAVER RETRACTORS

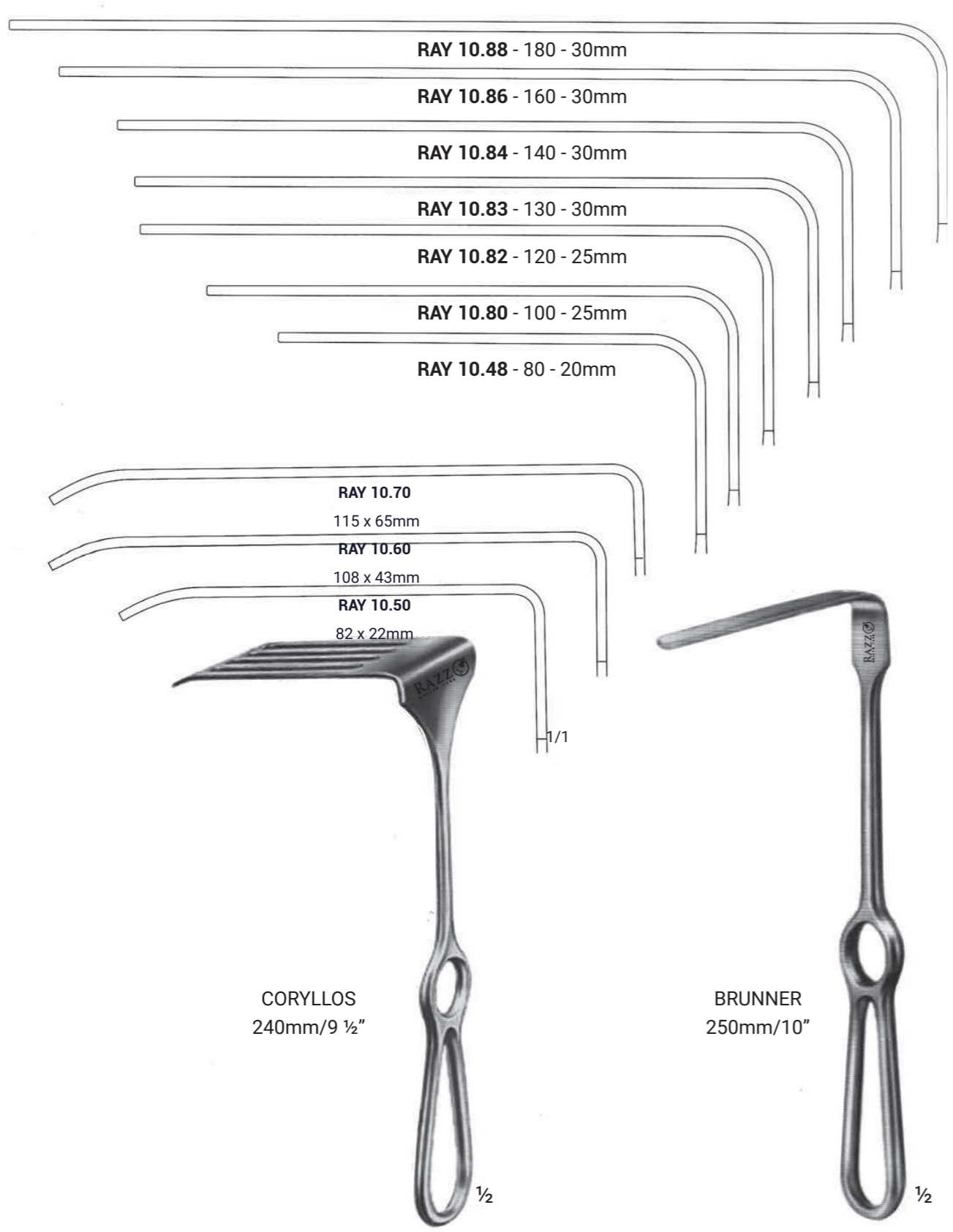

DEAVER RETRACTORS



RAY 11 .83
300mm/12"

RAY 11 .84
300mm/12"

RAY 11 .85 - 75mm
300mm/12"

RAY 11 .86 - 100mm
300mm/12"

SELF-RETAINING RETRACTORS

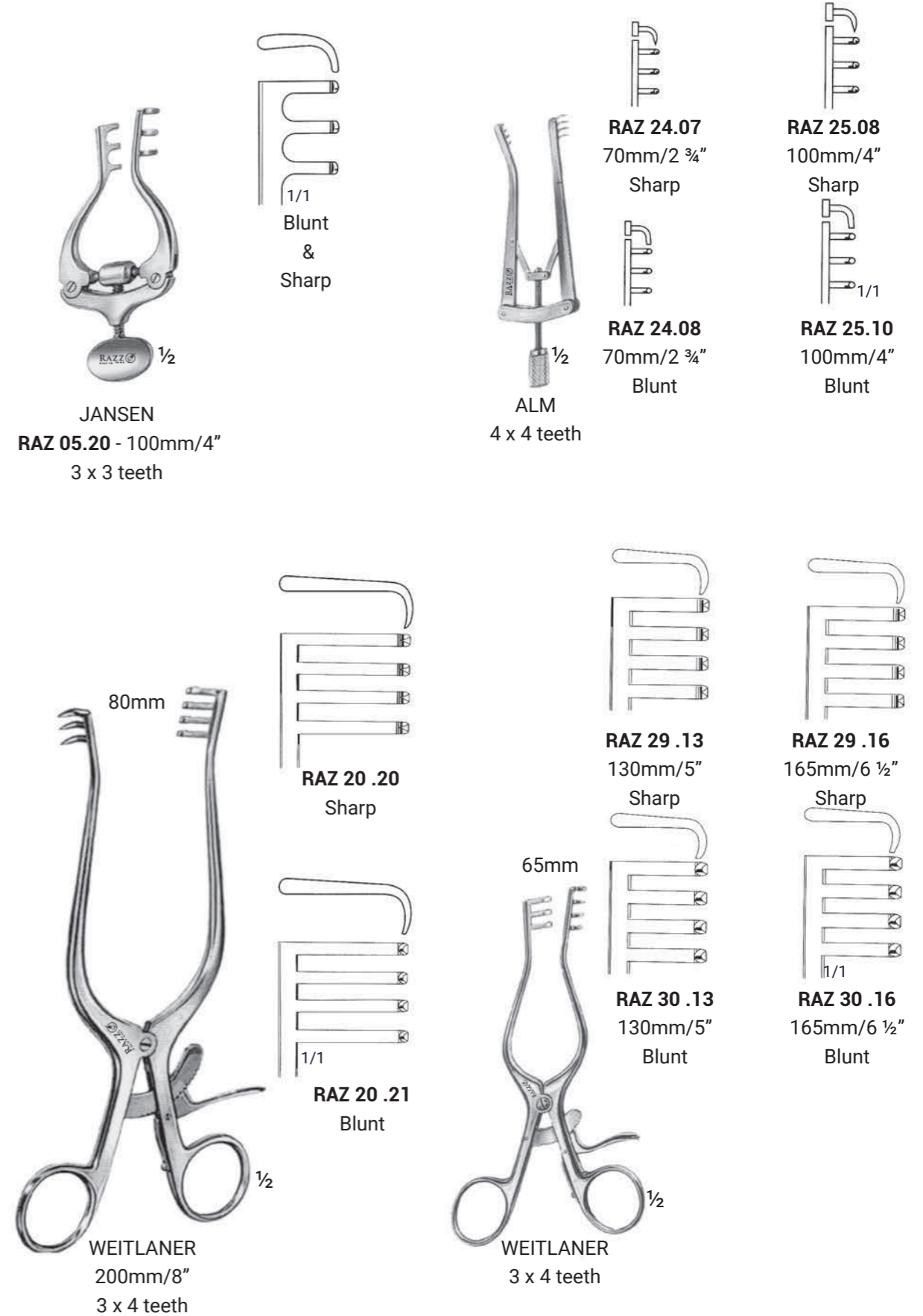

JANSEN
RAY 05.20 - 100mm/4"
3 x 3 teeth

WEITLANER
200mm/8"
3 x 4 teeth

ALM
4 x 4 teeth

RAZ 24.07
70mm/2 3/4"
Sharp

RAZ 24.08
70mm/2 3/4"
Blunt

RAZ 25.08
100mm/4"
Sharp

RAZ 25.10
100mm/4"
Blunt

RAZ 29.13
130mm/5"
Sharp

RAZ 30.13
130mm/5"
Blunt

RAZ 29.16
165mm/6 1/2"
Sharp

RAZ 30.16
165mm/6 1/2"
Blunt

RAZ 20 .20
Sharp

RAZ 20 .21
Blunt

SELF-RETAINING RETRACTORS

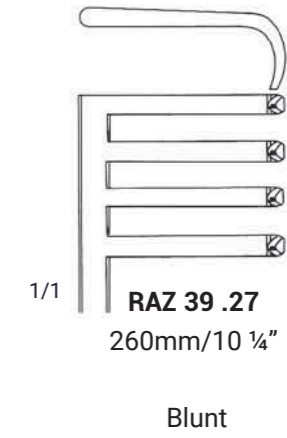
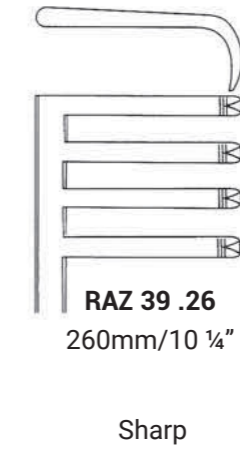
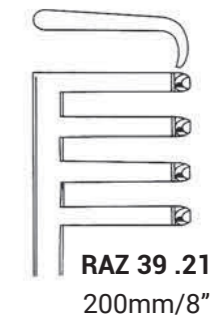
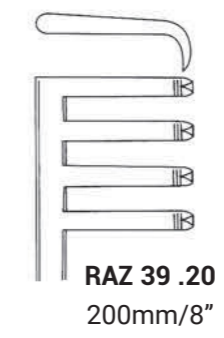
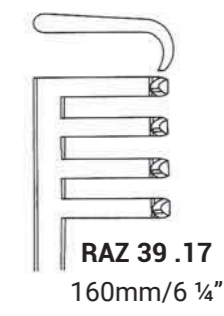
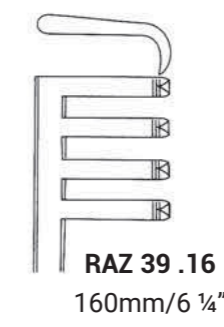
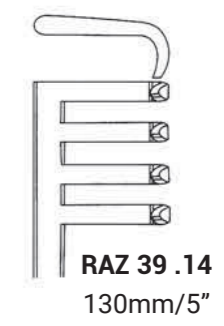
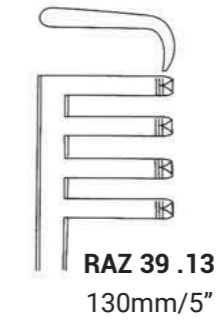
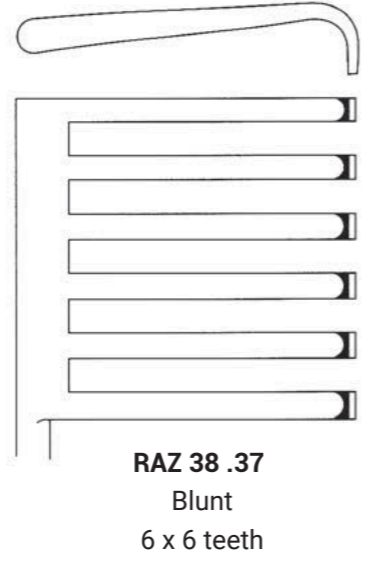
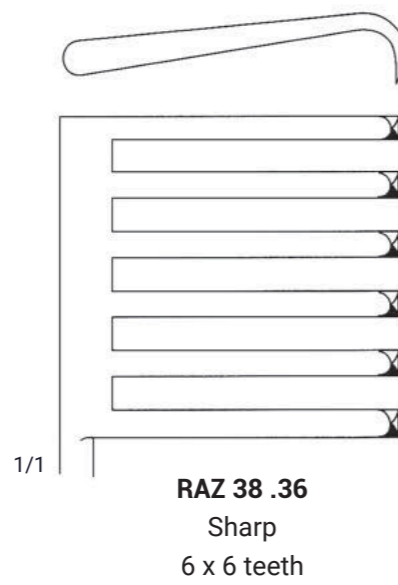
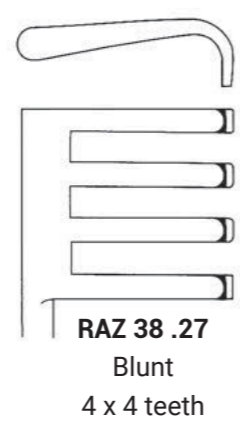
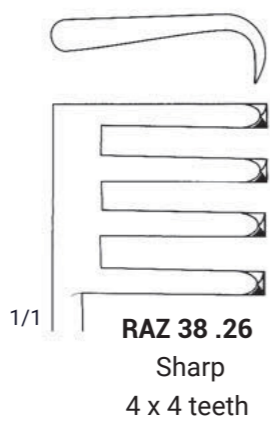

SELF-RETAINING RETRACTORS

SELF-RETAINING RETRACTORS

SELF-RETAINING RETRACTORS

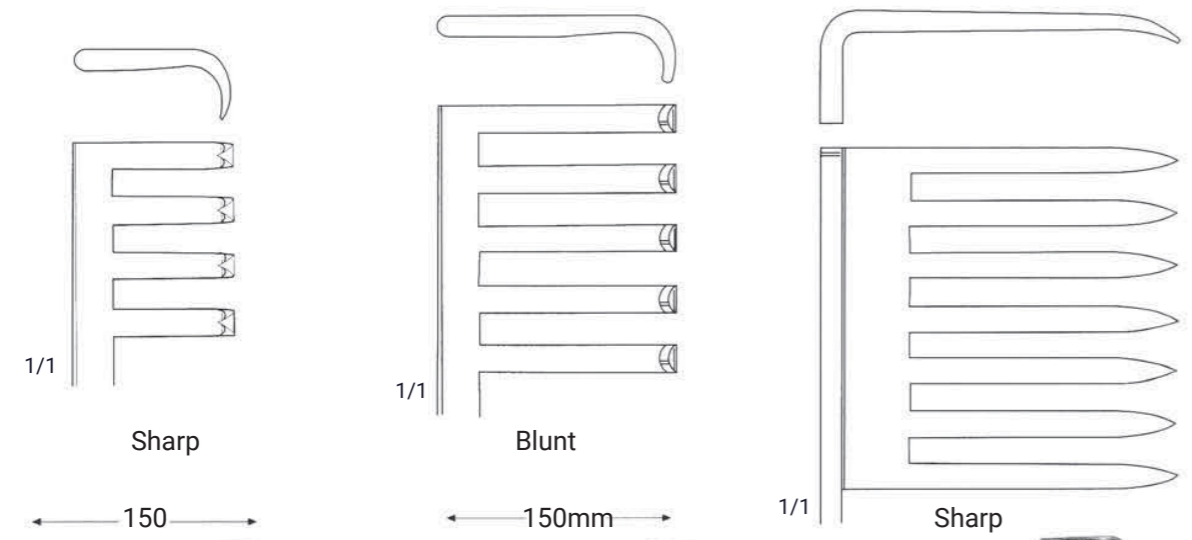

BECKMANN
RAZ 40 .31 - 310mm/12 1/2"
4 x 4 teeth



ADSON
RAZ 40 .32 - 320mm/12 1/2"
4 x 5 teeth



BECKMANN - EATON
RAZ 40 .35 - 320mm/12 1/2"
7 x 7 teeth



BECKMANN - ADSON
310mm/12 1/4"
4 x 4 teeth

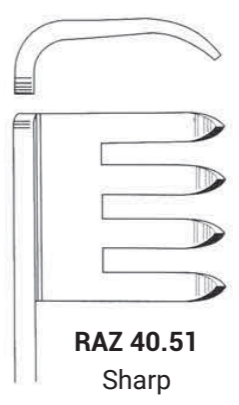

RAZ 40.51
Sharp

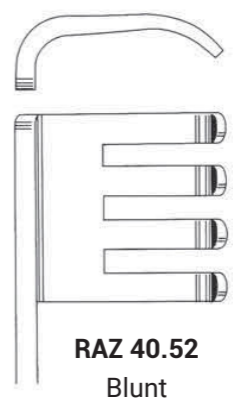

RAZ 40.52
Blunt

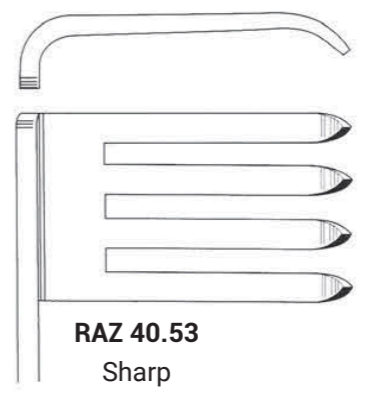

RAZ 40.53
Sharp

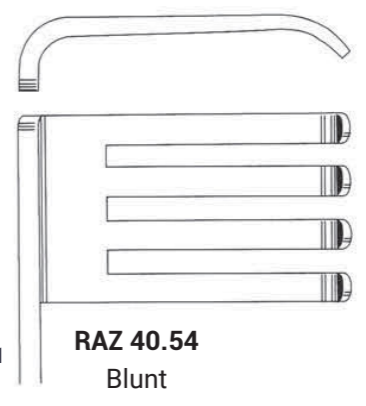

RAZ 40.54
Blunt

ABDOMINAL RETRACTORS

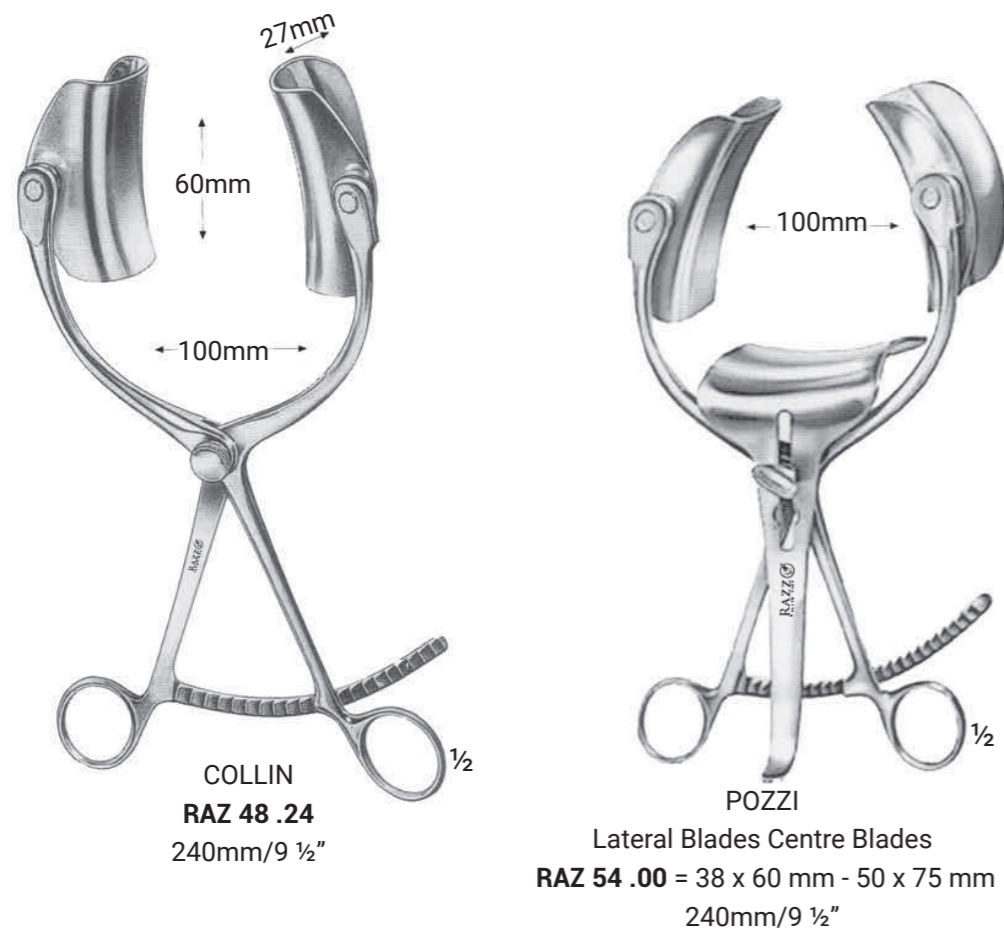
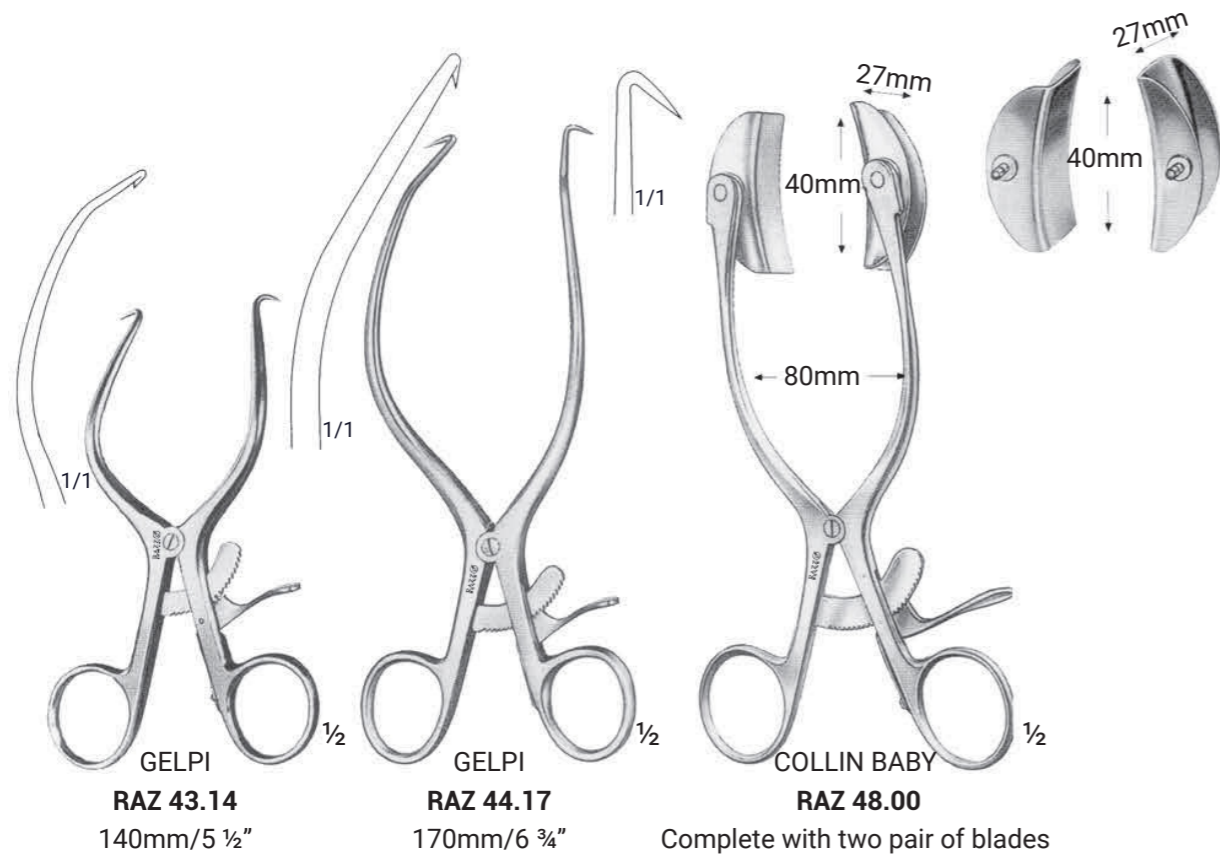

ABDOMINAL RETRACTORS

DENIS BROWNE
Universal Child
2 Valve Bades 40 x 30mm
2 Valve Bades 40 x 40mm
Frame 180 x 140mm



DENIS BROWNE
Universal Adult
2 Valve Bades 40 x 30mm
2 Valve Bades 40 x 40mm
Frame 250 x 180mm

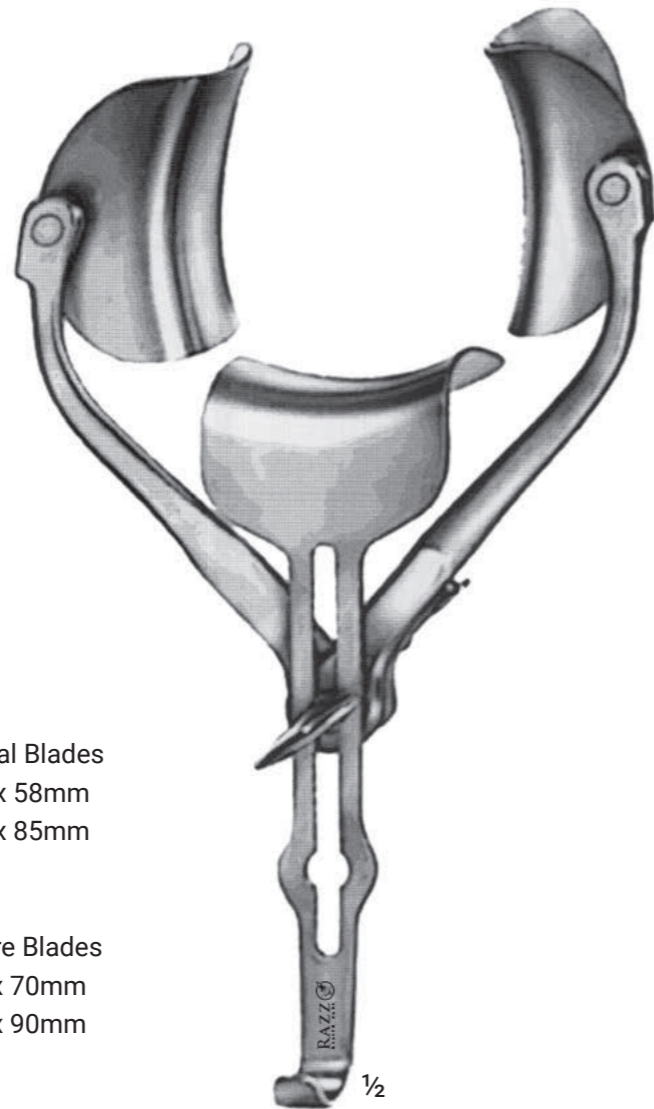

Lateral Blades
50 x 58mm
72 x 85mm

Centre Blades
55 x 70mm
80 x 90mm

RICARD
RAZ 59 .00 - 280mm/11"
RAZ 59 .01 - 300mm/12"



GOSSET - BABY
RAZ 60 .01

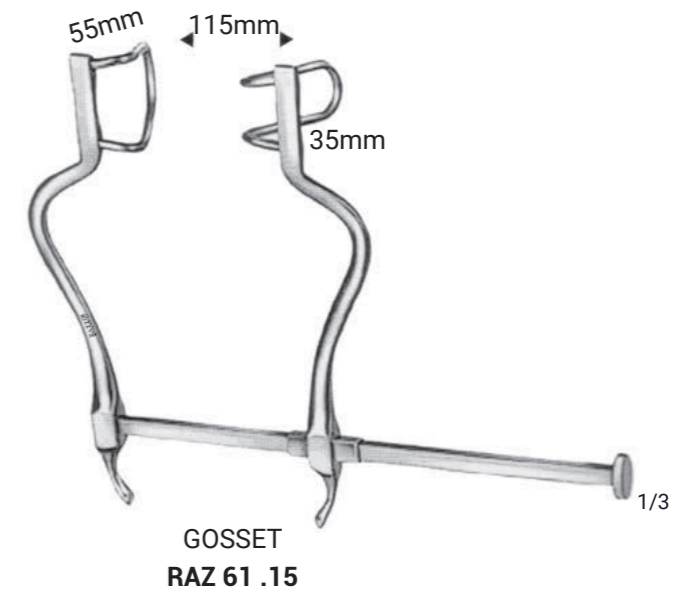

GOSSET
RAZ 61 .15

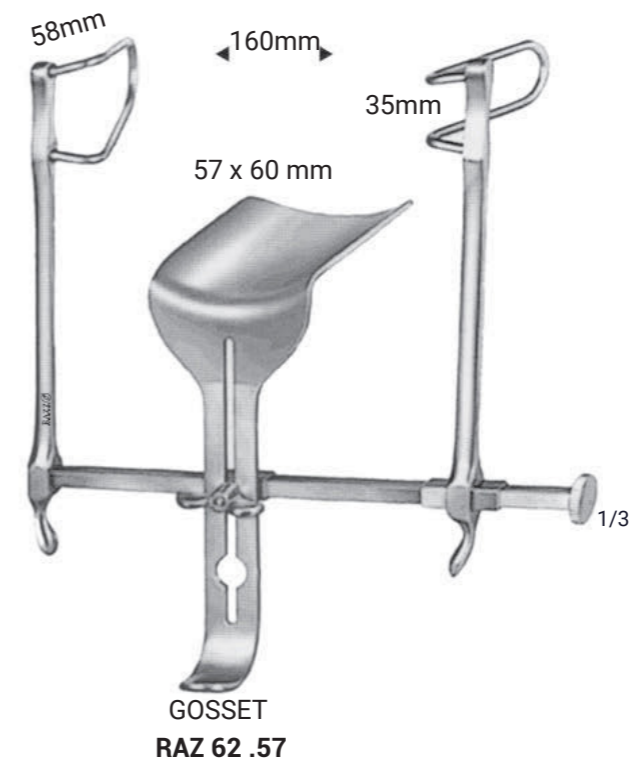

GOSSET
RAZ 62 .57

ABDOMINAL RETRACTORS

ABDOMINAL RETRACTORS



BALFOUR BABY
RAZ 66 .01

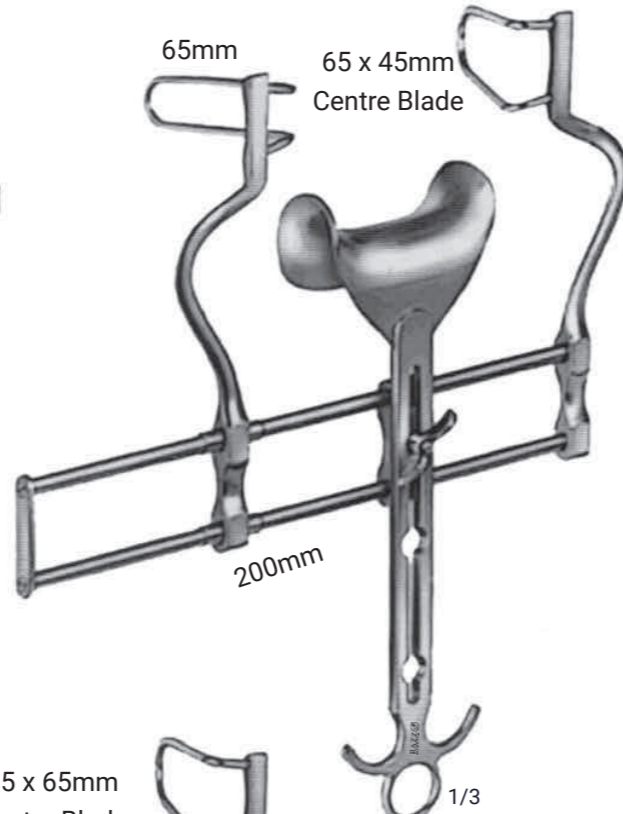

BALFOUR
RAZ 69 .10

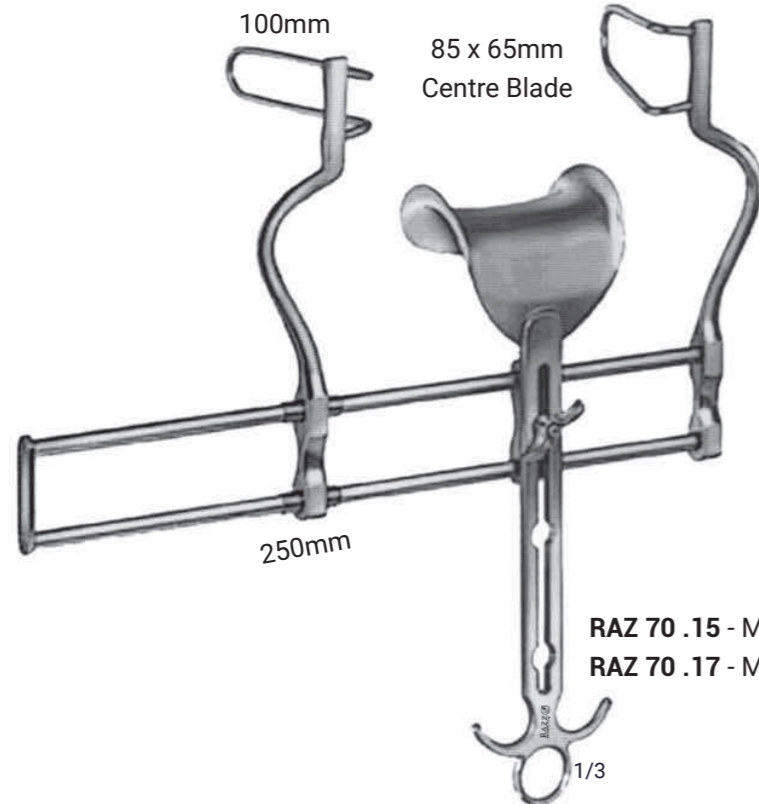

BALFOUR
RAZ 70 .15 - Maximum Spread 200 mm
RAZ 70 .17 - Maximum Spread 250 mm

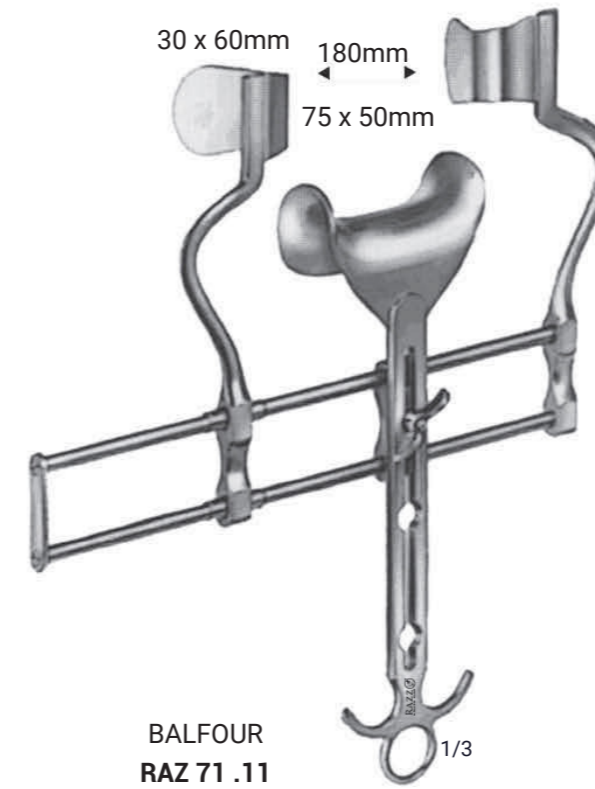

BALFOUR
RAZ 71 .11

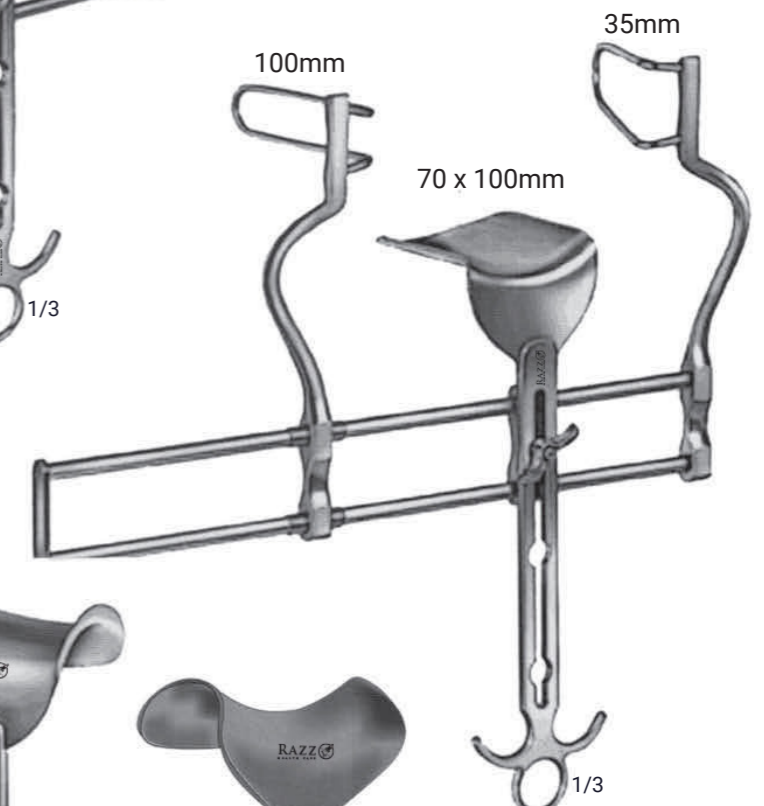

BALFOUR
RAZ 72 .11 - Maximum Spread 200 mm
RAZ 72 .12 - Maximum Spread 250 mm



BALFOUR
RAZ 75 .20 - 63 x 38mm
RAZ 75 .30 - 75 x 50mm



RAZ 76 .40 - 85 x 65mm
RAZ 76 .41 - 80 x 80mm

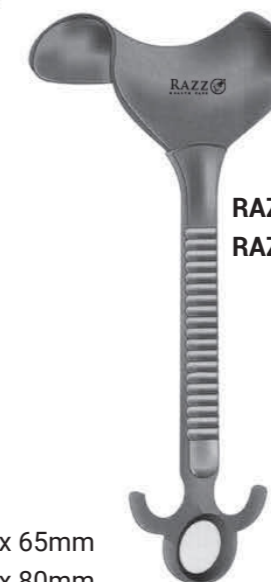

DOYEN
RAZ 87 .01 - 95 x 60 mm
RAZ 87 .02 - 105 x 65 mm
RAZ 87 .03 - 115 x 65 mm
RAZ 87 .04 - 125 x 65 mm

ABDOMINAL RETRACTORS

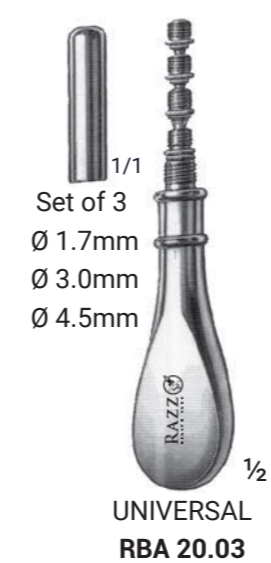
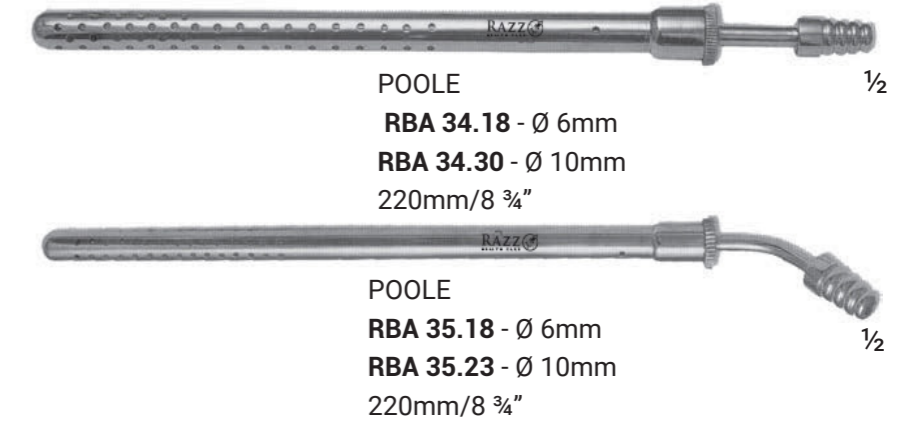
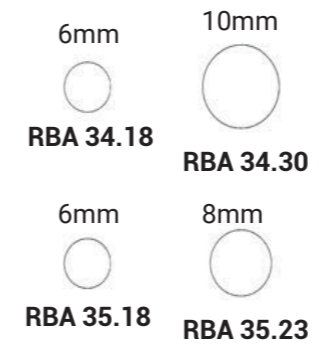
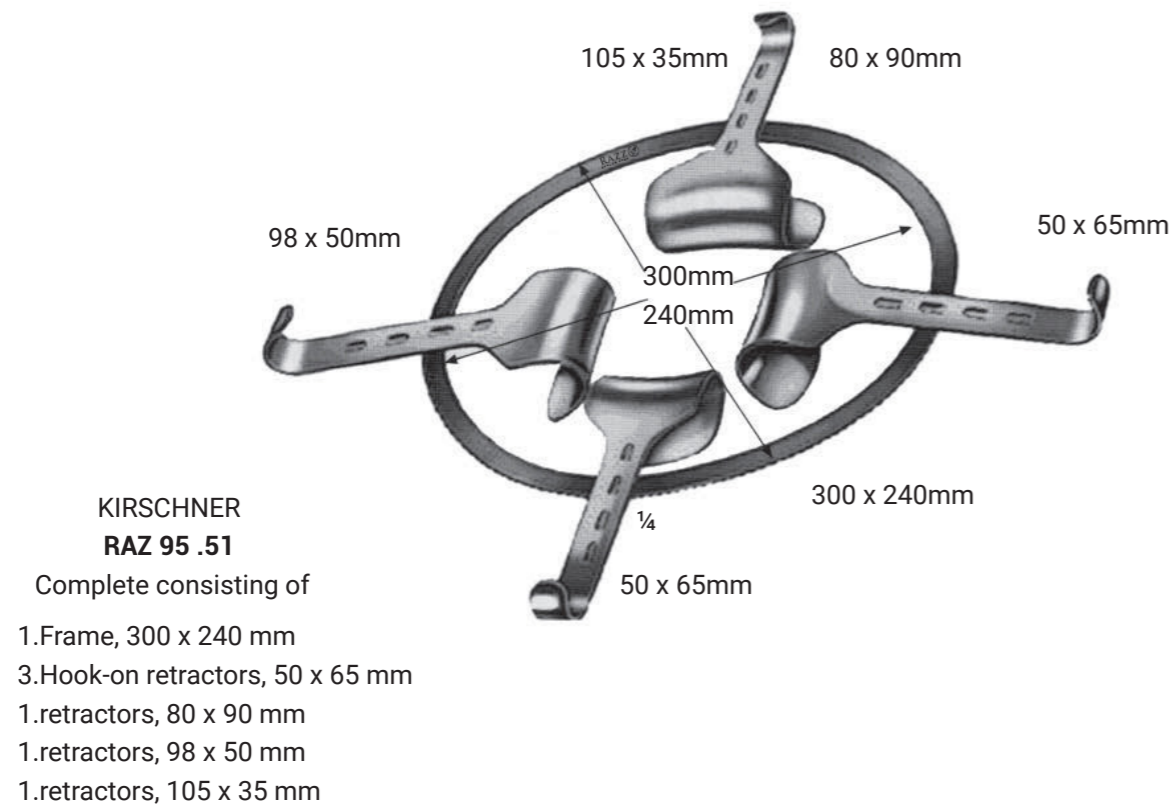
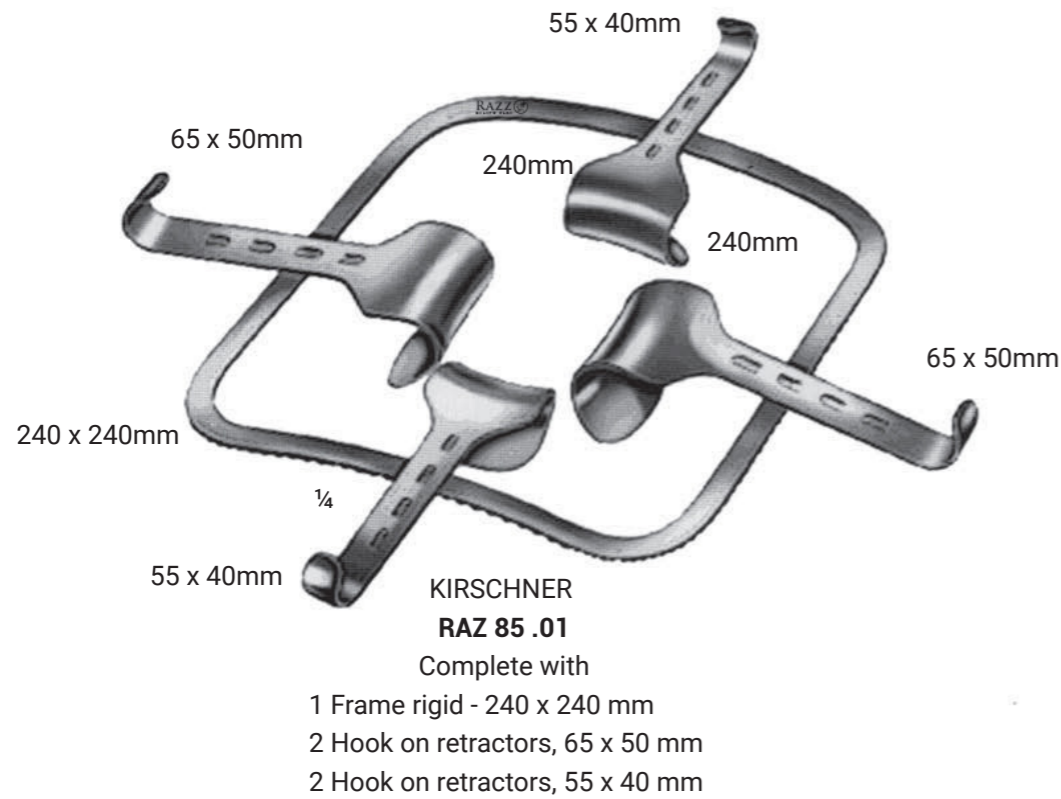

FRAZIER

125mm/5"	180mm/7"	125mm/5"	180mm/7"
RBA 36.06	RBA 36.56	RBA 36.36	RBA 36.86
RBA 36.08	RBA 36.58	RBA 36.38	RBA 36.88
RBA 36.10	RBA 36.60	RBA 36.40	RBA 36.90
RBA 36.12	RBA 36.62	RBA 36.42	RBA 36.92

TROCARS & SUCTION TUBES

PROBES & COTTON APPLICATORS

TUBING CLAMPS

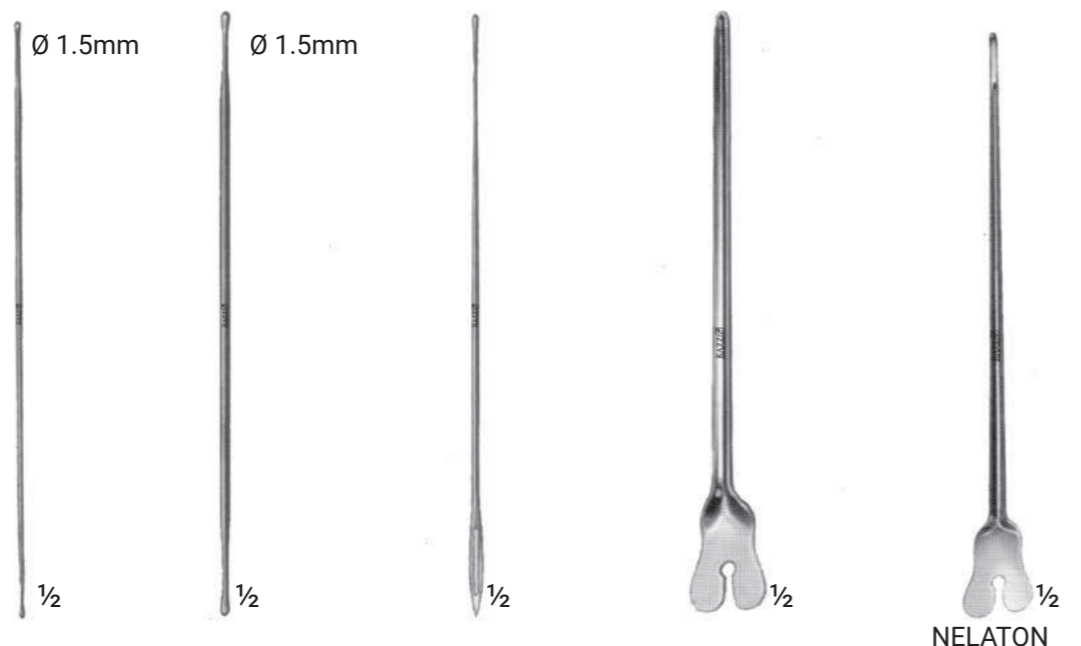

145mm/5 1/2"	RBA 01.14	RBA 02.14	RBA 05.14	RBA 07.14	-
160mm/6 1/4"	RBA 01.16	RBA 02.16	RBA 05.16	RBA 07.16	RBA 10.66
180mm/7"	RBA 01.18	RBA 02.18	RBA 05.18	RBA 07.18	-
200mm/8"	RBA 01.20	RBA 02.20	RBA 05.20	RBA 07.20	-



STACKE
RBA 12.10
105mm/4 1/4"



MARTYLE
RBA 13.14 - 145mm/5 1/2"
RBA 13.16 - 160mm/6 1/4"

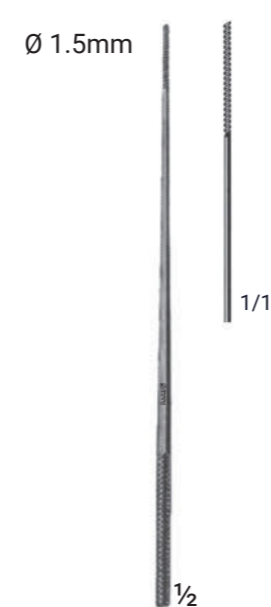

FARREL (FROHN)
RBA 16.12 - 120mm/4 3/4" Ø 0.9mm
RBA 16.14 - 145mm/5 1/2" Ø 0.9mm
RBA 16.16 - 160mm/6 1/4" Ø 1.1mm

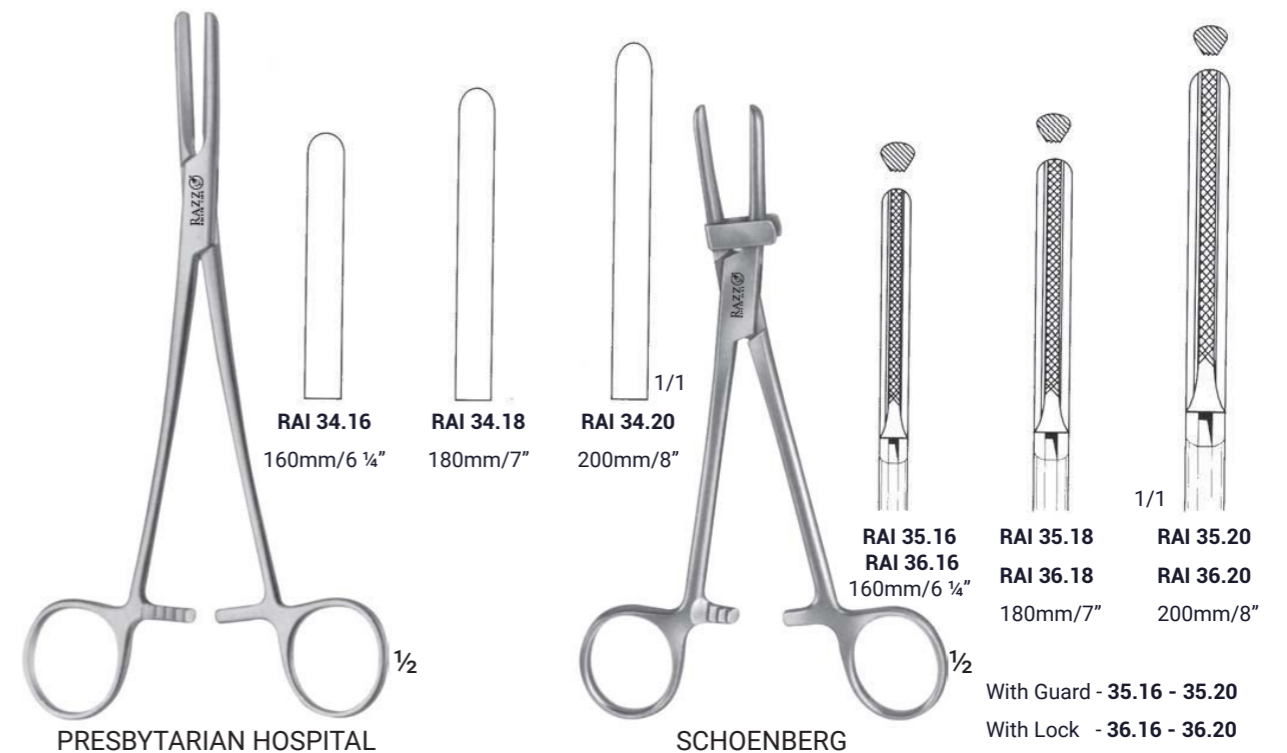

PRESBYTARIAN HOSPITAL

SCHOENBERG

With Guard - 35.16 - 35.20
With Lock - 36.16 - 36.20



CHEATTLE
RAI 03.27 - 270mm/10 1/2"



RAI 19.20 - 200mm/8"
RAI 19.30 - 300mm/12"

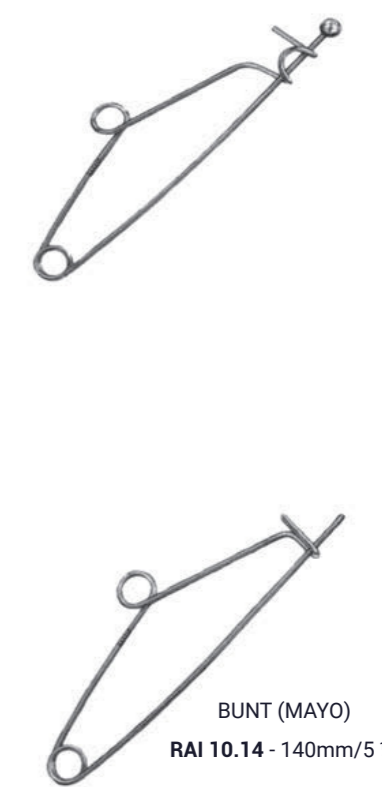

BUNT (MAYO)
RAI 10.14 - 140mm/5 1/2"

SKIN GRAFTING KNIFE



SILVER
Skin Graft Knife
without Blade
190mm/7 1/2"
RSG 10.01



HUMBY
Skin Graft Knife
without Blade
300mm/12"
RSG 10.00



COBBETT
Skin Graft Knife
without Blade
315mm/12 1/2"
RSG 10.02



GYNECOLOGY

VAGINAL SPECULA

VAGINAL RETRACTORS

KRISTELLER
Specula

Fig 1. **RAO 14.27** - 70 x 27mm
Fig 2. **RAO 14.30** - 75 x 30mm
Fig 3. **RAO 14.36** - 90 x 36mm



KRISTELLER
Retractors

Fig 1. **RAO 16.24** - 75 x 23mm
Fig 2. **RAO 16.26** - 80 x 26mm
Fig 3. **RAO 16.33** - 100 x 32mm



KRISTELLER
Set of 1 Speculum and
1 Retractor

Fig 1. **RAO 17.12**
Fig 2. **RAO 17.20**
Fig 3. **RAO 17.30**



KRISTELLER
Specula

Fig 1. **RAO 18.20** - 110x18mm
Fig 2. **RAO 18.21** - 110 x 21mm



KRISTELLER
Retractors

Fig 1. **RAO 18.25** - 115 x 14mm
Fig 2. **RAO 18.26** - 115 x 17mm



KRISTELLER
Set of 1 Speculum
and 1 Retractor each

Fig 1. **RAO 18.30**
Fig 2. **RAO 18.31**



MATHIEU
RAO 09.10 - 95 x 16 - 26mm
RAO 09.15 - 95 x 16 - 30mm
Vaginal Specula

MATHIEU
RAO 09.25 - 100 x 11 - 20mm
RAO 09.35 - 100 x 14 - 26mm
Vaginal Retractor



KRISTELLER

Fig 1. **RAO 11.27** - 110 x 27mm
Fig 2. **RAO 11.30** - 110 x 30mm
Fig 3. **RAO 11.36** - 110 x 36mm

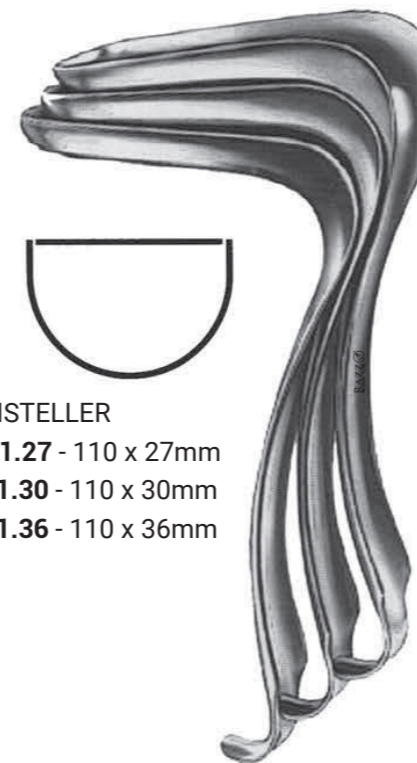

KRISTELLER
Fig 1. **RAO 10.27** -110 x 27mm
Fig 2. **RAO 10.30** -110 x 30mm
Fig 3. **RAO 10.36** -110 x 36mm



KRISTELLER
Retractors
Fig 1. **RAO 12.23** - 115 x 23
Fig 2. **RAO 12.36** - 115 x 26
Fig 3. **RAO 12.32** - 115 x 32

VAGINAL SPECULA



SIMS
RAO 21.10 - Small
RAO 21.20 - Medium
RAO 21.30 - Large



KALLMORGAN
 Fig 1. 70 x 33mm -**RAO 22.07**
 Fig 2. 90 x 33mm -**RAO 22.09**

KALLMORGAN
 Set of 1 Speculum and Retractor
 Fig 1 **RAO 22.70**
 Fig 2 **RAO 22.90**



KALLMORGAN
 Specula
 Fig 1 **RAO 22.40** - 70 x 40 mm
 Fig 2 **RAO 22.55** - 90 x 40 mm

VAGINAL RETRACTORS



COLLIN
RAO 23.25 - 90 x 25mm
RAO 23.29 - 90 x 29mm
RAO 23.35 - 100 x 35mm
RAO 23.40 - 100 x 40mm
RAO 23.36 - 110 x 36mm
RAO 23.41 - 110 x 40mm

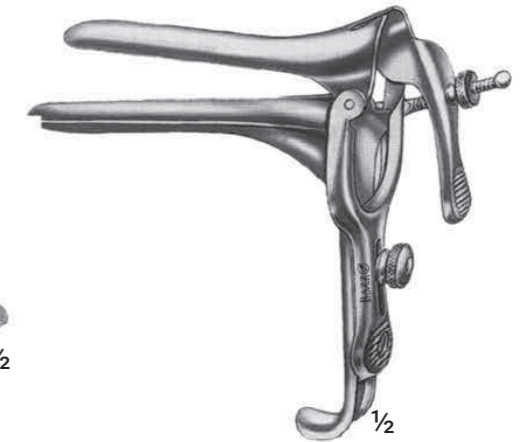

PEDERSON
RAO 29.13 - 76 x 13mm
RAO 29.22 - 100 x 22mm
RAO 29.25 - 120 x 25mm

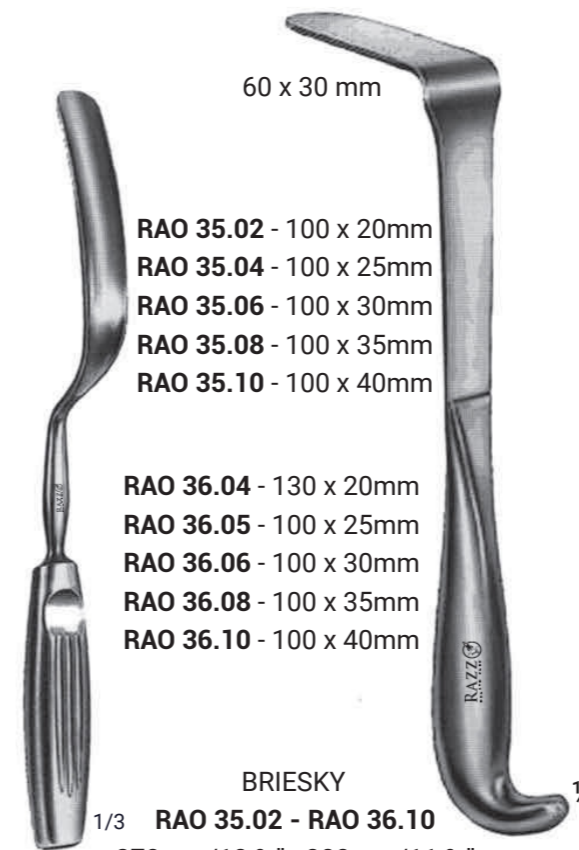

RAO 35.02 - 100 x 20mm
RAO 35.04 - 100 x 25mm
RAO 35.06 - 100 x 30mm
RAO 35.08 - 100 x 35mm
RAO 35.10 - 100 x 40mm

RAO 36.04 - 130 x 20mm
RAO 36.05 - 100 x 25mm
RAO 36.06 - 100 x 30mm
RAO 36.08 - 100 x 35mm
RAO 36.10 - 100 x 40mm

BRIESKY
RAO 35.02 - RAO 36.10
 270mm/10 3/4" - 300mm/11 3/4"

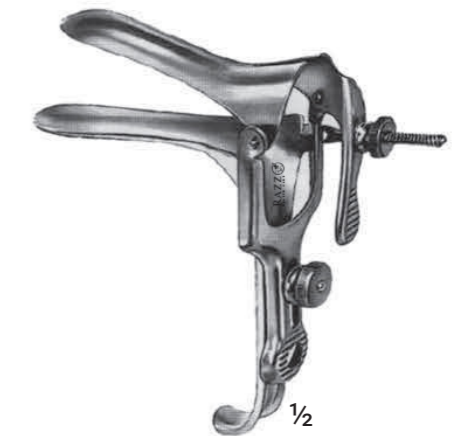

GRAVES
RAO 30.20 - 75 x 20mm
RAO 30.30 - 100 x 30mm
RAO 30.35 - 115 x 35mm

DOYEN
RAO 06.23
 230mm/9"

VAGINAL SPECULA

VAGINAL SPECULA AND RETRACTORS

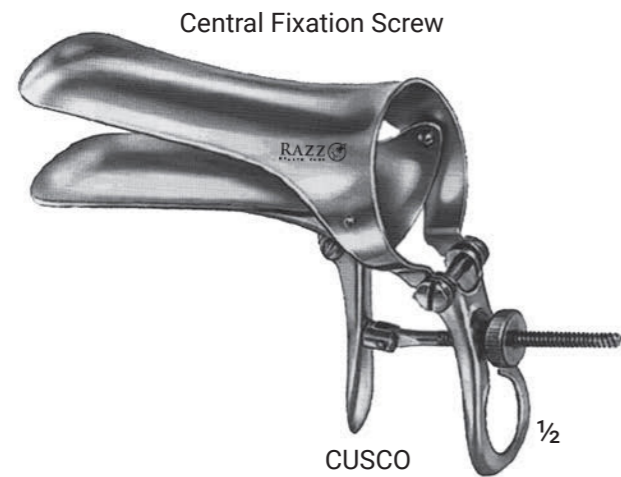

RAO 32.32 - 75 x 32mm
 RAO 32.36 - 85 x 36mm
 RAO 32.37 - 95 x 37mm
 RAO 32.38 - 100 x 37mm



RAO 34.75 - 75 x 17mm

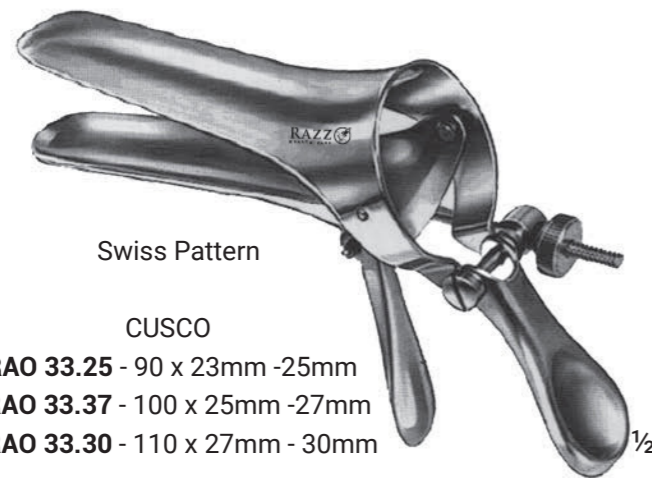

RAO 33.25 - 90 x 23mm -25mm
 RAO 33.37 - 100 x 25mm -27mm
 RAO 33.30 - 110 x 27mm - 30mm



RAO 34.32 - 75 x 32mm - Small
 RAO 34.36 - 85 x 36mm - Medium
 RAO 34.37 - 95 x 37mm - Large
 RAO 34.38 - 100 x 35mm -Extra Large

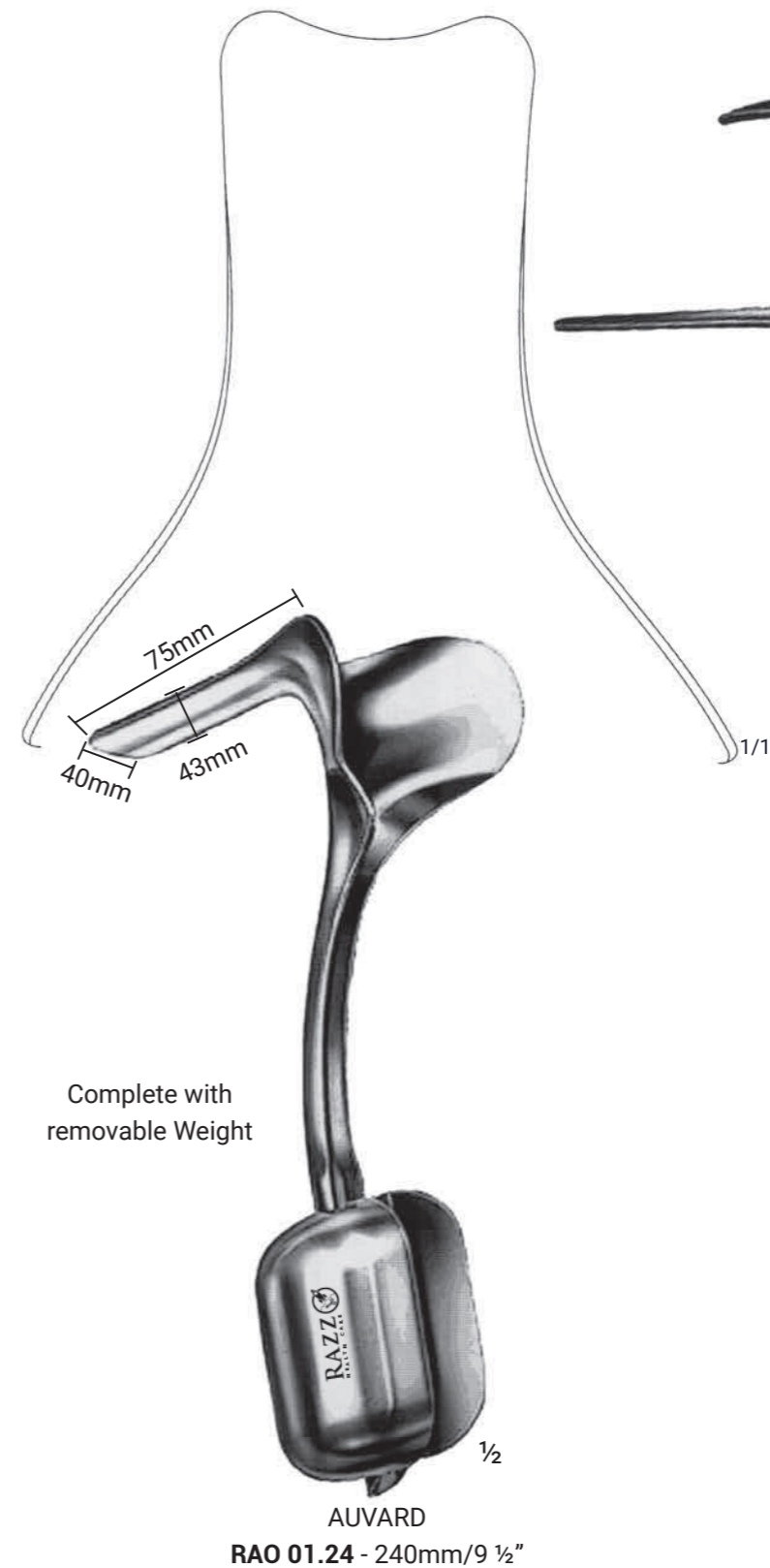

SINUS & DRESSING FORCEPS

SWAB FORCEPS & SPONGE HOLDING FORCEPS

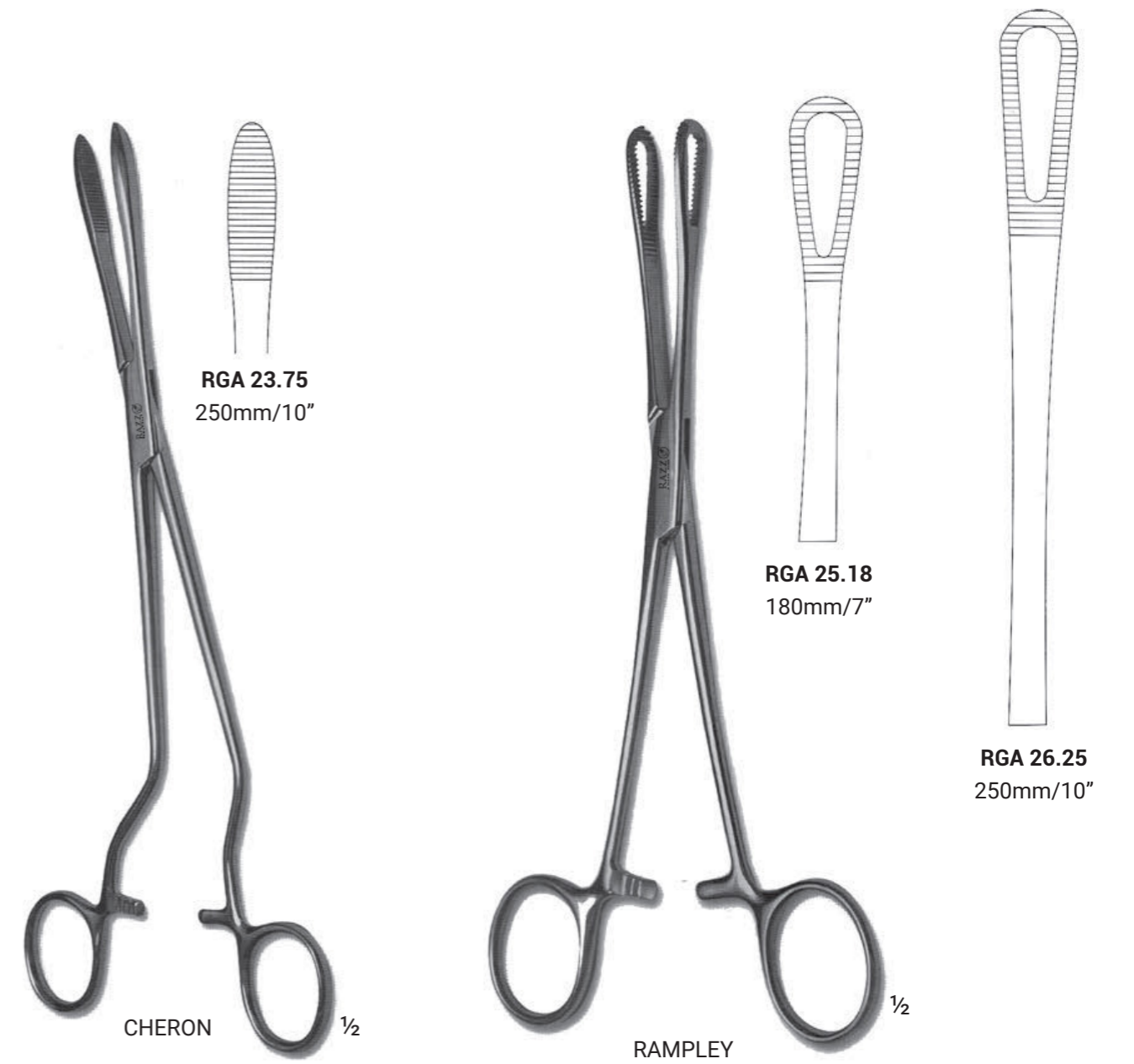
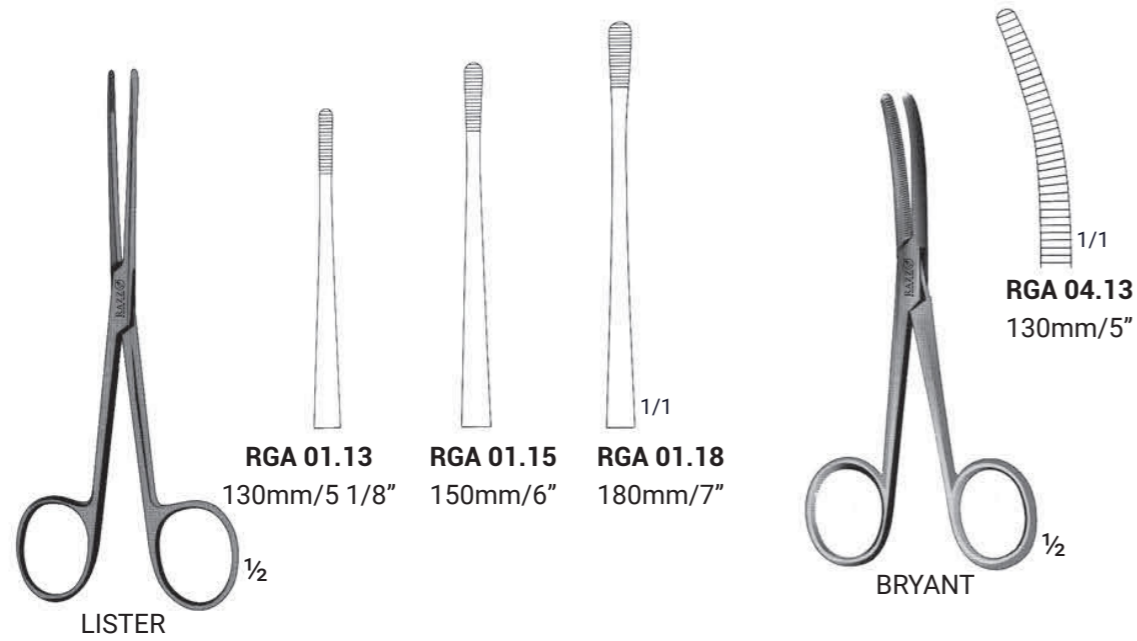

DRESSING FORCEPS

DRESSING FORCEPS



150mm/6"
RAO 16.60

180mm/7"
RAO 16.62

200mm/8"
RAO 16.64

250mm/10"
RAO 16.66

300mm/12"
RAO 16.68



RAMPLEY
SPONGE FORCEPS
250mm/10"
RAO 16.70



RAO 16.70



OVUM
FORCEPS
200mm/8"
RAO 16.50

6mm

RAO 16.51

8mm

RAO 16.52

10mm

1/1

RAO 16.53

OVUM
FORCEPS
250mm/10"
RAO 16.51 - RAO 16.53

DRESSING FORCEPS & SPONGE FORCEPS

HYSTERECTOMY FORCEPS

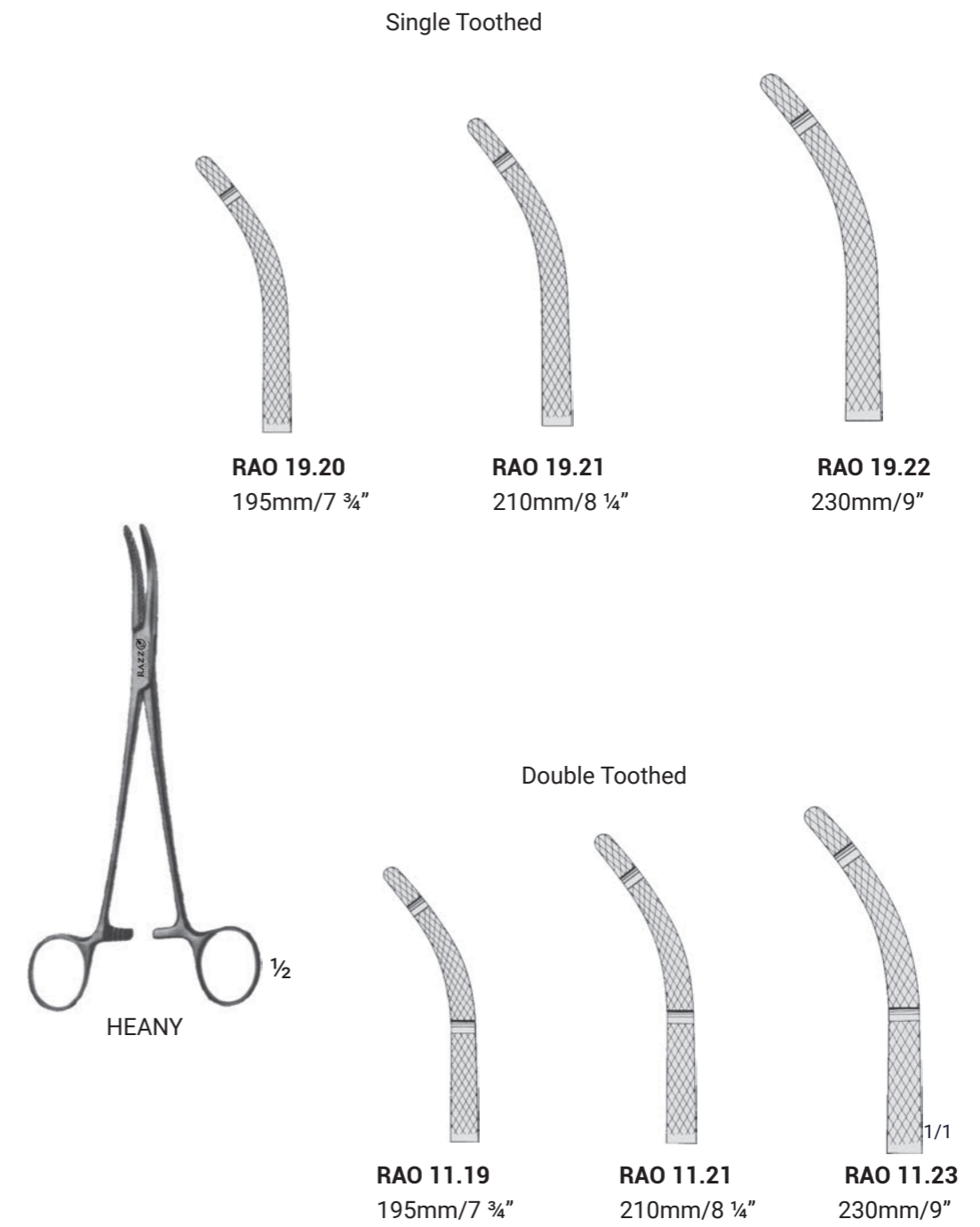
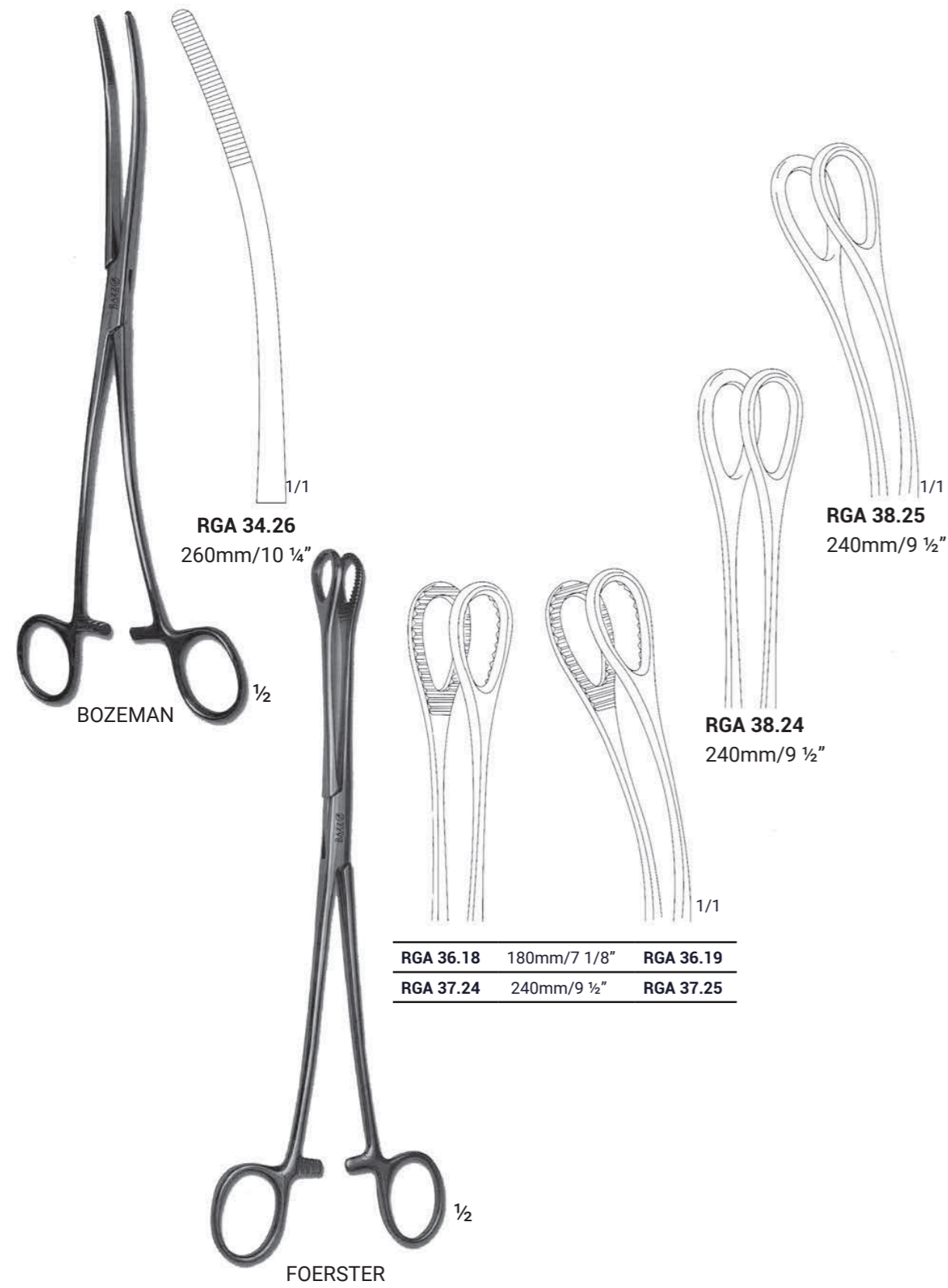

ARTERY FORCEPS, HYSTERECTOMY & VAGINAL CLAMP FORCEPS

PERITONEAL CLAMP FORCEPS

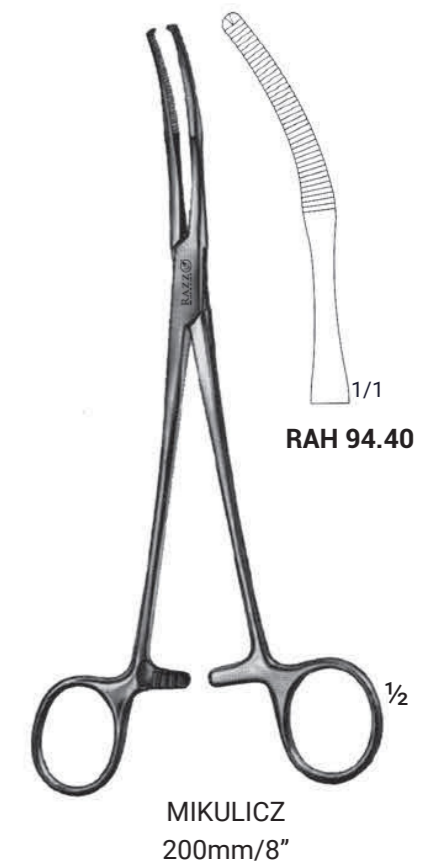
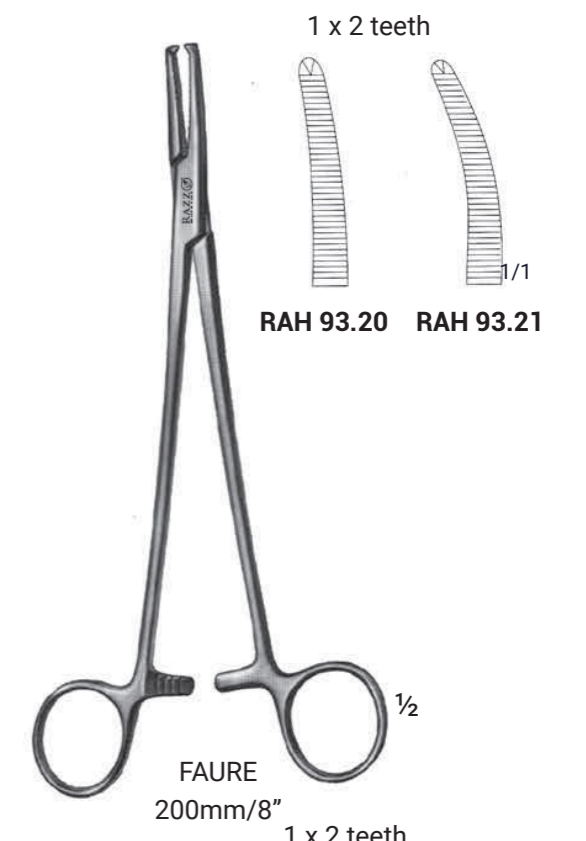

TENACULUM FORCEPS

VULSELLUM FORCEPS

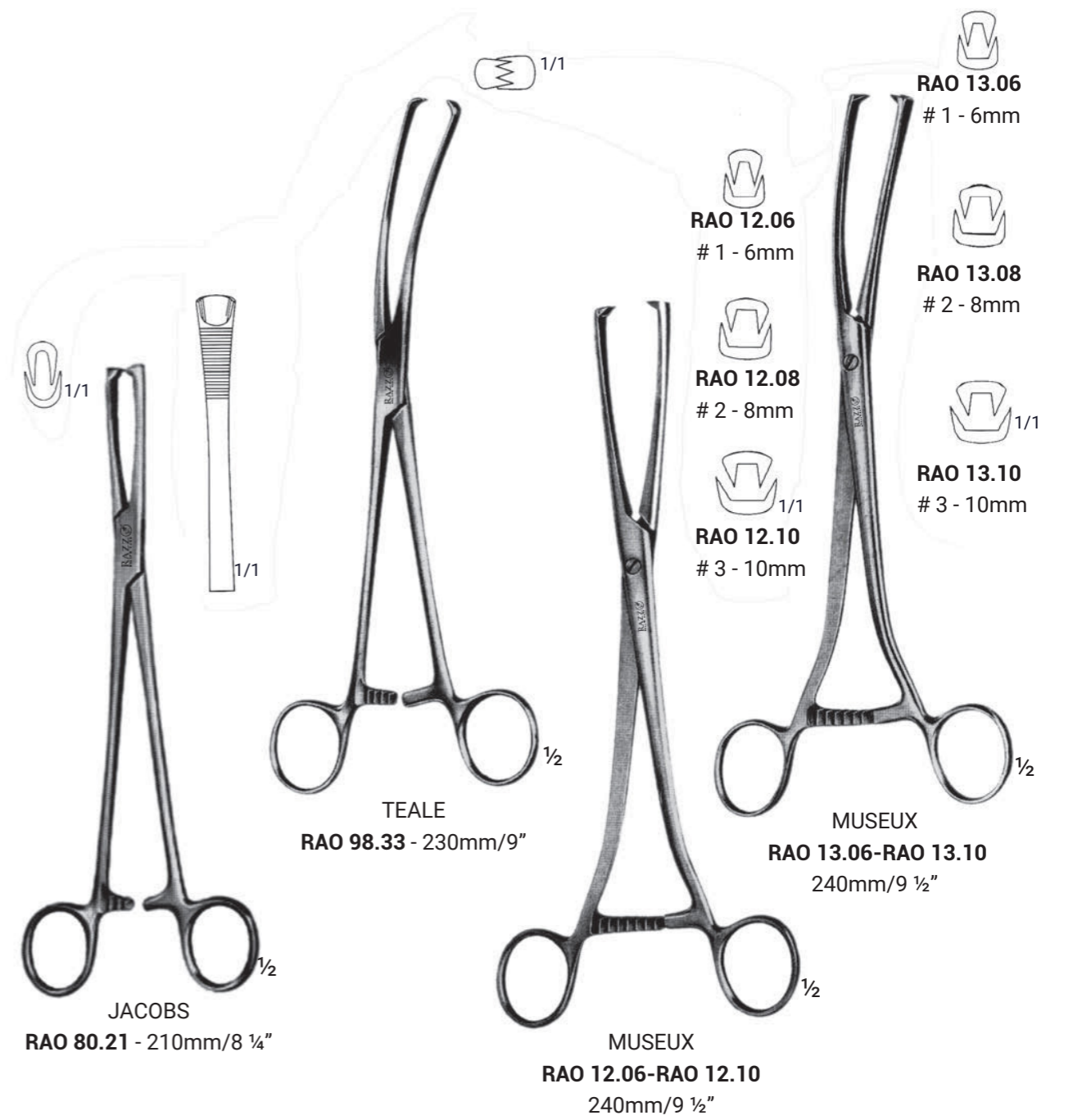
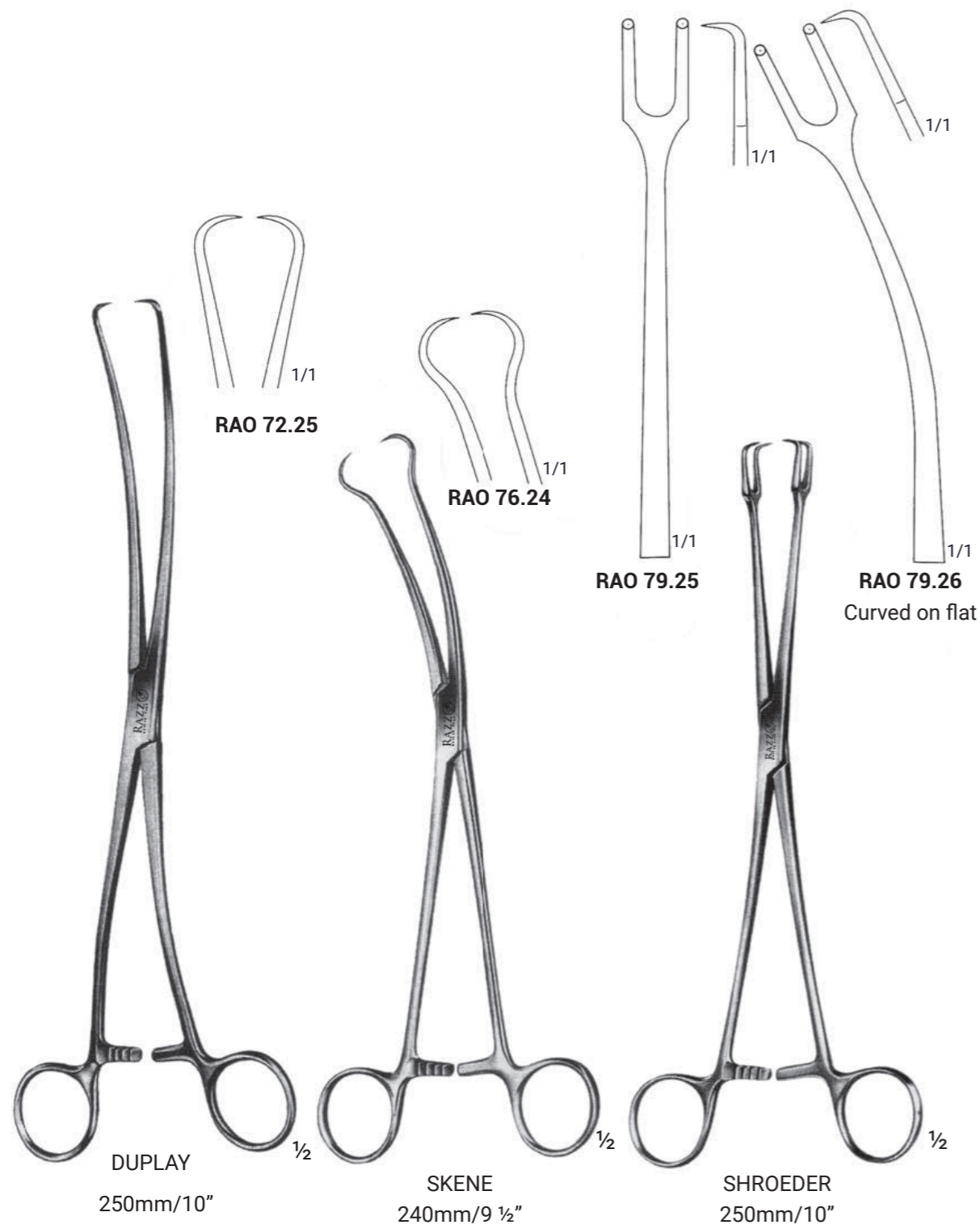

UTERINE MANIPULATOR

UTERINE MYOMETOMY CLAMP & TENACULUM FORCEPS

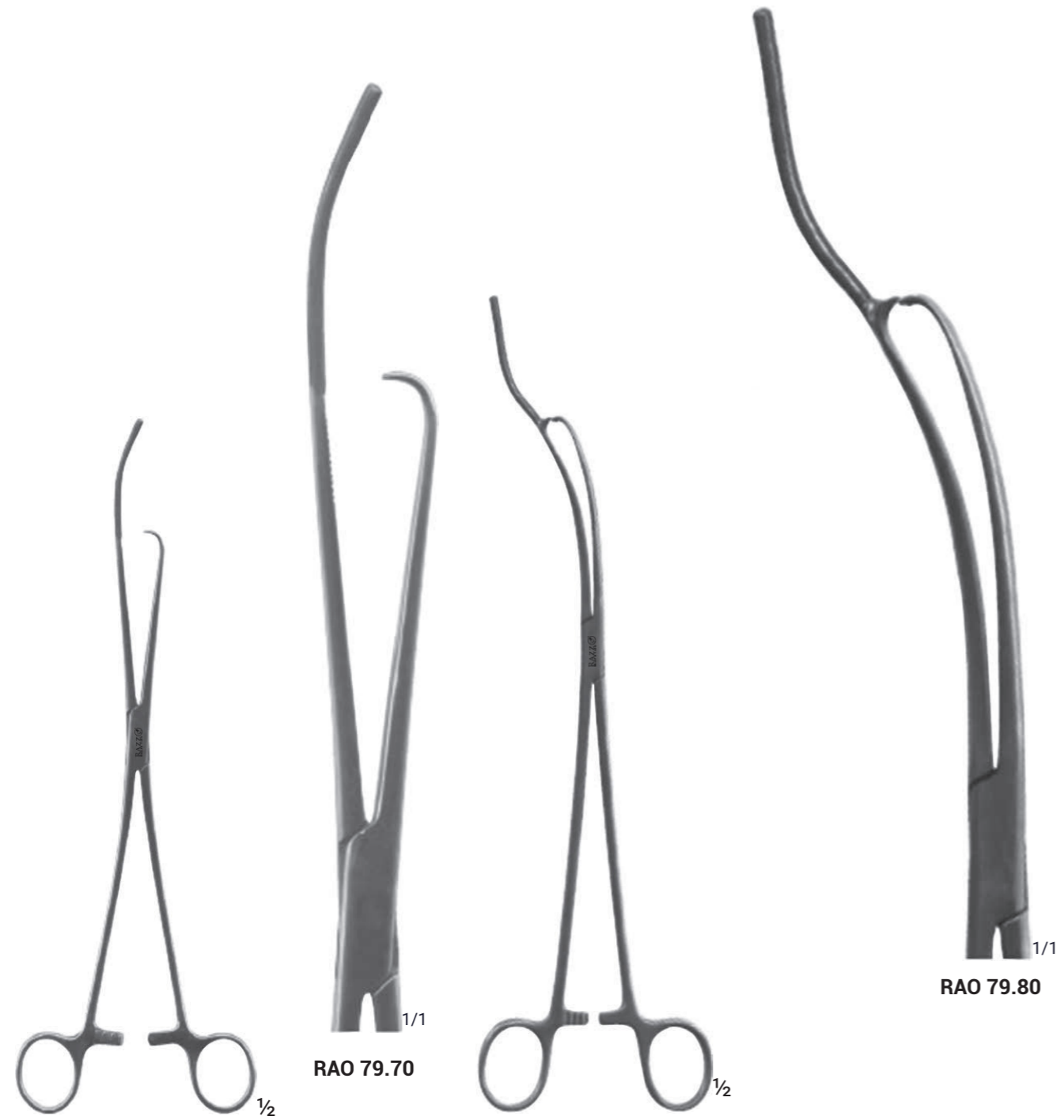

RAZZO
UTERINE TANACULUM
MANIPULATOR WITH
COPPER PROBE END
280mm/11"

RAO 79.70

RAZZO
UTERINE TANACULUM
MANIPULATOR WITH
COPPER PROBE END
300mm/12"

RAO 79.80



BONNEYS
MYOMETOMY CLAMP
ANGLED ON FLAT
SCREW JOINT
250mm/10"
(RAO 13.25)



RAZZO
UTERINE VULSELLUM FORCEPS
WITH PROBE END
300mm/12"
(RAO 79.50)



RAZZO
UTERINE TENACULUM FORCEPS
'S' SHAPED
1 x 1 TEETH
250mm/10"
(RAO 79.60)

TENACULUM FORCEPS

OVARY AND POLYPUS FORCEPS

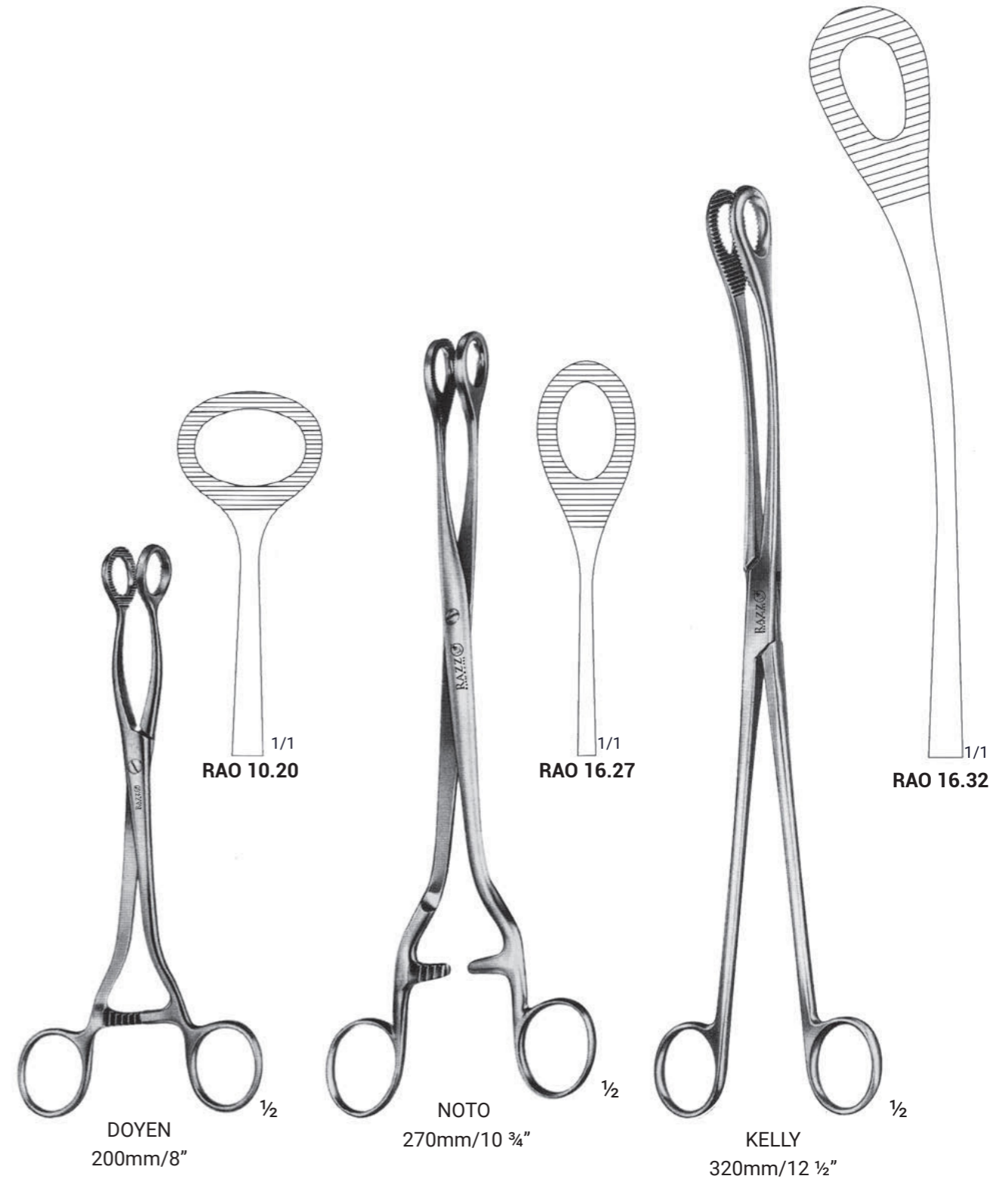
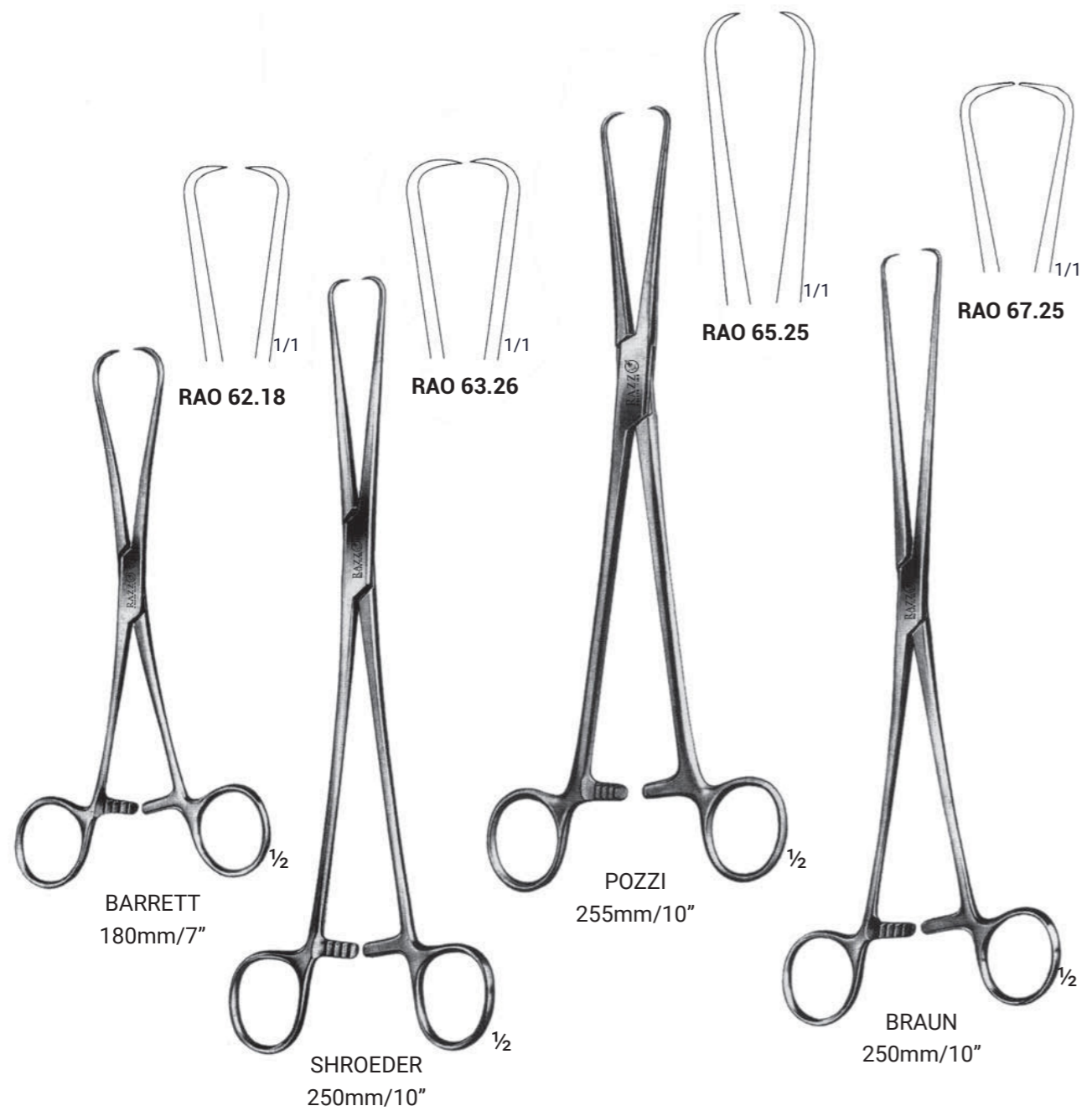

UTERINE ELEVATING FORCEPS

ELEVATING SPOON, CORD CLAMPS & PLACENTA FORCEPS

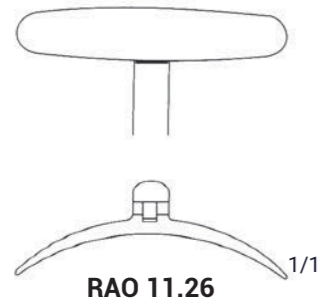

RAO 11.26 1/1

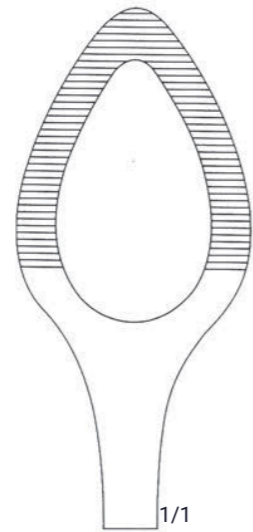

RAO 11.24 1/1

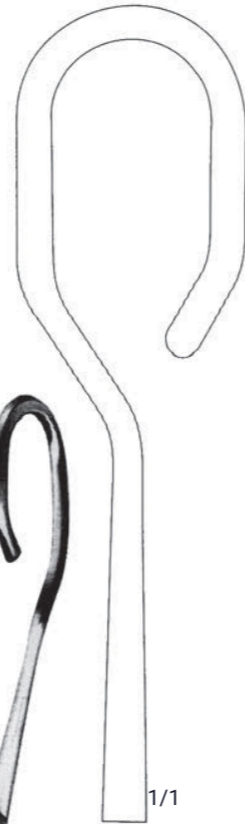

RAO 11.32 1/1



COLLIN 260mm/10 1/4" 1/2



SOMER 240mm/9 1/2" 1/2



DARTIGUES 260mm/10 1/4" 1/2



SELHEIM RAP 25.28 280mm/11" 1/4



KANE RAP 35.09 85mm/3 1/2" 1/2



COLLIN RAP 36.09 90mm/3 1/2" 1/2



WINTER 280mm/11" 1/3

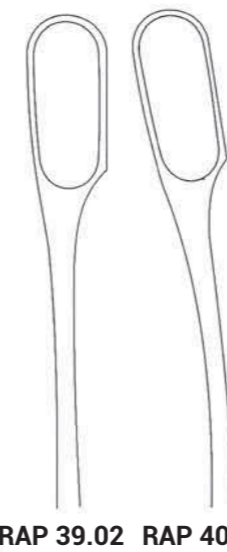

RAP 39.02



RAP 40.12

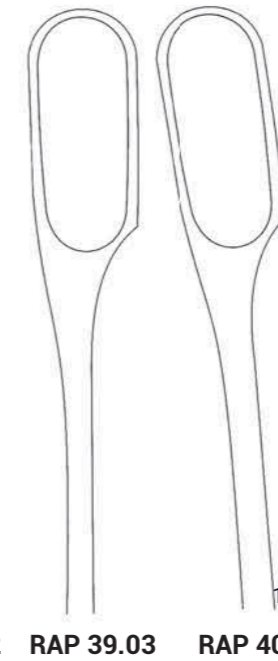

RAP 39.03



RAP 40.15 1/1

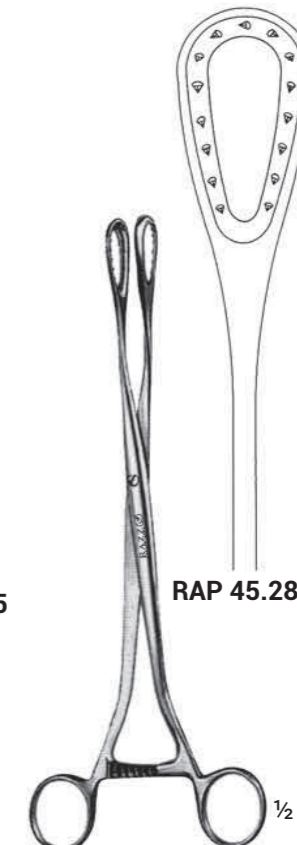

SAENGER 290mm/11 1/2" 1/2

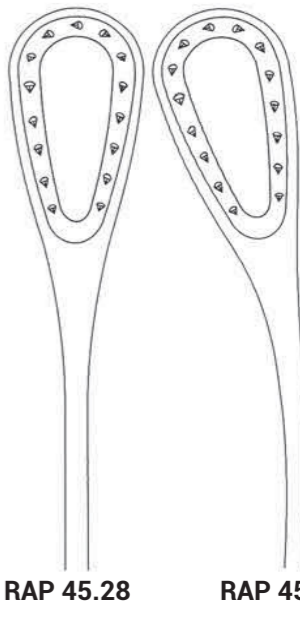

RAP 45.28



RAP 45.29 1/1

CERVICAL PUNCH BIOPSY FORCEPS

CERVICAL PUNCH BIOPSY FORCEPS



FAURE
230mm/9"
RAO 20.23



SCHUBERT
240mm/9 1/2"
RAO 21.24



VAN DOREN
240mm/9 1/2"
RAO 22.24



VAN DOREN
CERVICAL PUNCH
WITHOUT RATCHAT
250mm/10"
RAO 20.24



CERVICAL PUNCH
BIOPSY FORCEPS
TOTAL LENGTH 200mm
RAO 20.60 - RAO 20.80

- 6mm
○
RAO 20.60
- 7mm
○
RAO 20.70
- 8mm
○
RAO 20.80

SHAFT LENGTH 125mm



CERVICAL BIOPSY FORCEPS

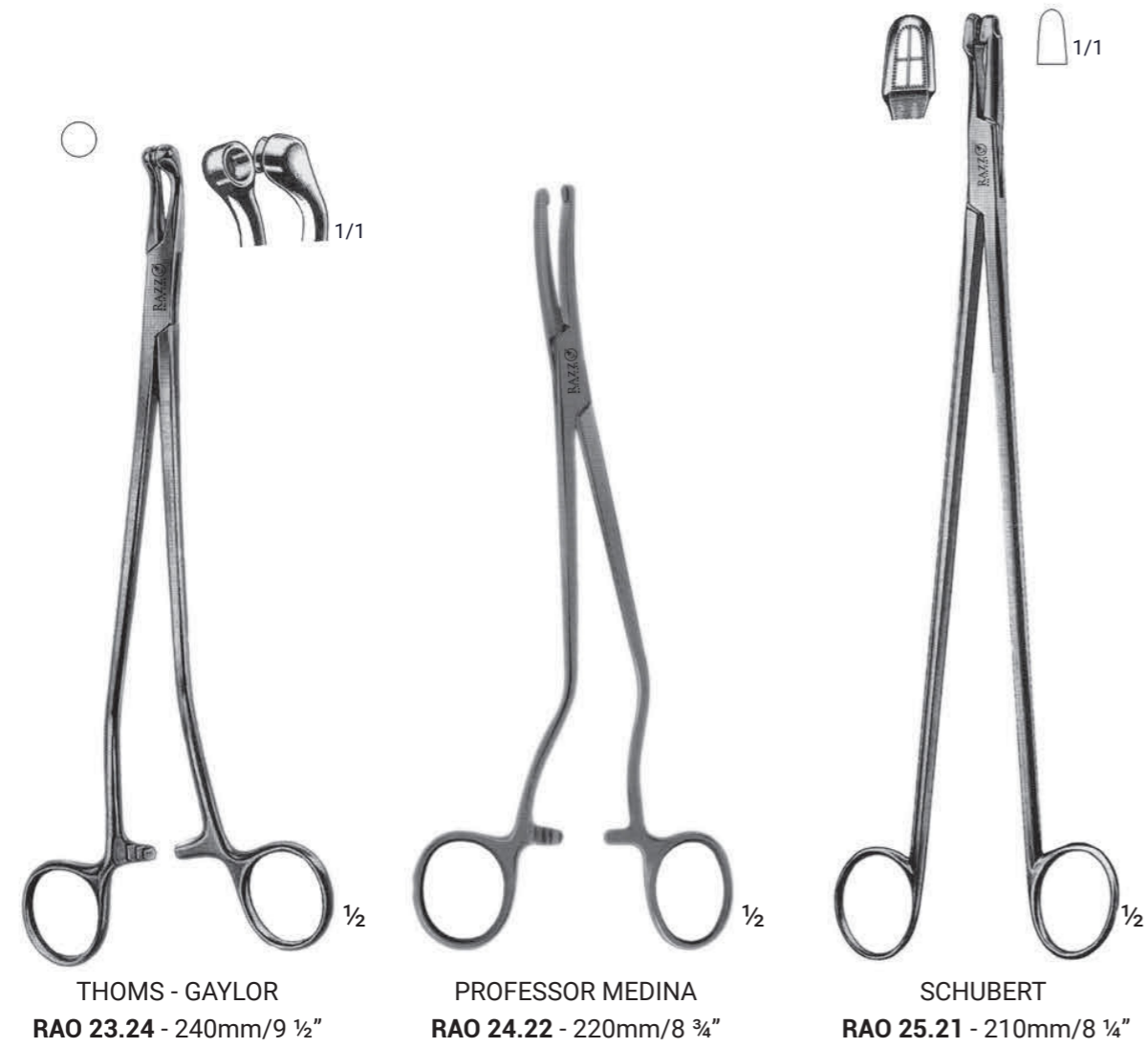

CERVICAL BIOPSY FORCEPS

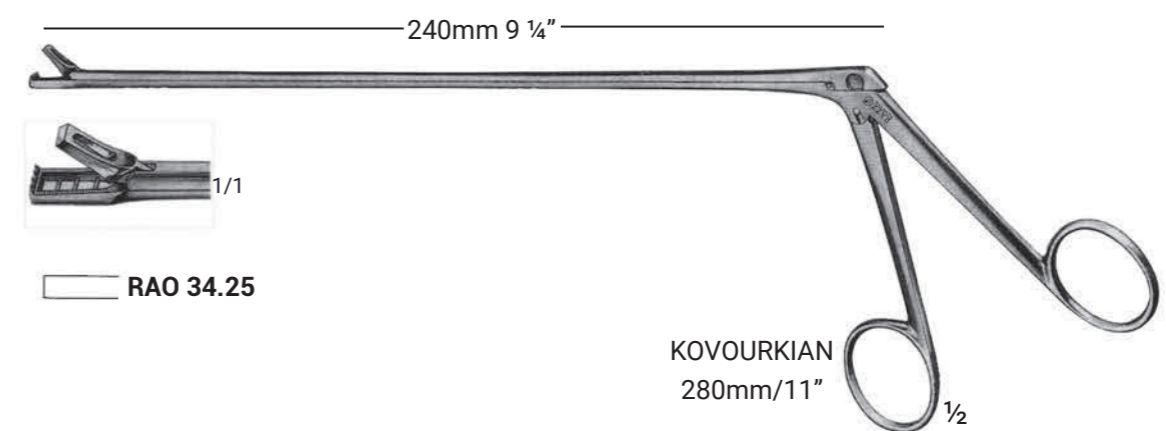
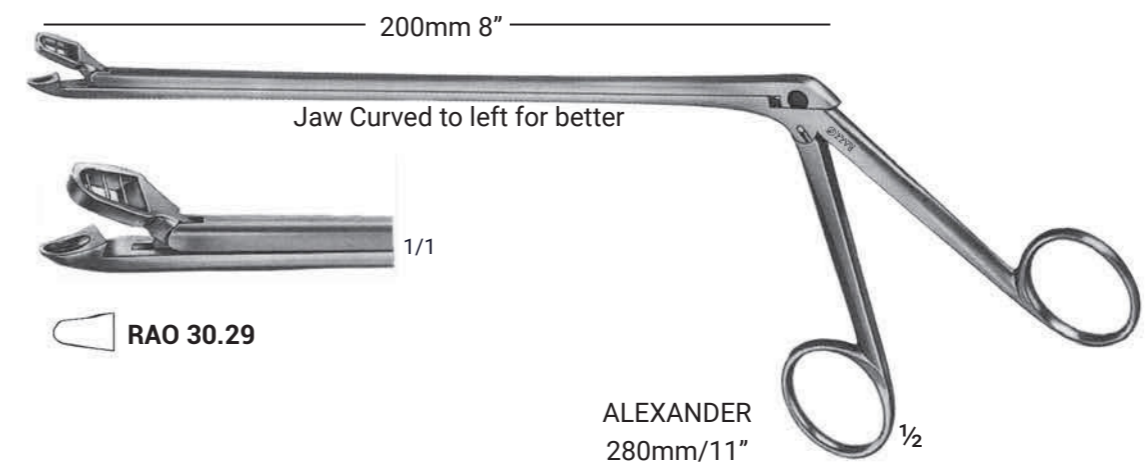
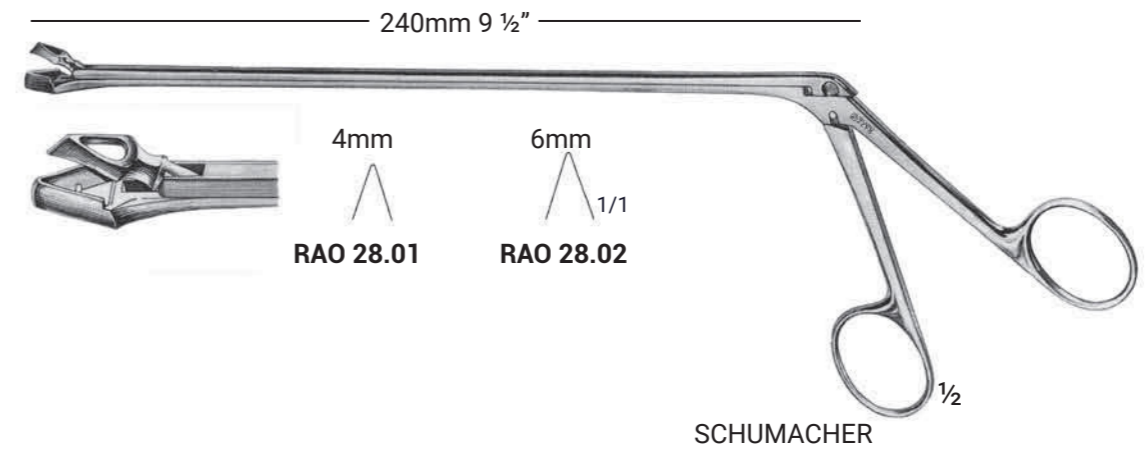

ENDOCERVICAL SPECULA

MYOMA SCREWS & SUCTION BIOPSY CURETTES



KOGAN
RAO 47.40 - 240mm/9 1/2"



KOGAN
RAO 47.24 - 240mm/9 1/2"



DOYEN
MYOMA SCREW
RING HANDLE
FOUR SPIRAL
180mm/7"
RAO 35.20



DOYEN
MYOMA SCREW
RING HANDLE
TWO SPIRAL
150mm/6"
RAO 35.29



DOYEN
RAO 36.20
170mm/6 3/4" - Ø 20mm



DOYEN
RAO 36.29
140mm/5 1/2" - Ø 29mm



NOVAK
RAO 13.23
230mm/9"



KOVOURKIAN - YOUNG
RAO 39.30 - 300mm/12"

UTERINE CURETTES/ CANNULAE

UTERINE DEPRESSOR



SIMS
UTERINE CURETTES
275mm/10 3/4"
RAO 39.50 - RAO 39.52



LEECH - WILKINSON
250mm/10"
RAO 39.70 - 39.90



Small
RAO 39.70



Medium
RAO 39.80



Large
RAO 39.90



SIMS
Uterine Depressor
Double Ended Toothed
260mm/10 1/2"
RAO 57.27



20mm



25mm

3/4



24mm

BRAUN
Uterine Depressor
Double Ended Plain
270mm/10 3/4"
RAO 58.27

3/4

UTERINE SCOOPS

UTERINE CURETTE

SIMON
290mm/11 1/2"
Rigid, Sharp

RAO 14.07
#1 - 7mm

RAO 14.08
#2 - 8mm

RAO 14.10
#3 - 10mm

RAO 14.11
#4 - 11mm

RAO 14.12
#5 - 12mm

RAO 14.15
#6 - 15mm

SCHROEDER
300mm/12"
Rigid, Sharp

RAO 14.01
#1 - 7mm

RAO 14.02
#2 - 8mm

RAO 14.03
#3 - 10mm

RAO 14.04
#4 - 11mm

RAO 14.05
#5 - 12mm

RAO 14.06
#6 - 15mm

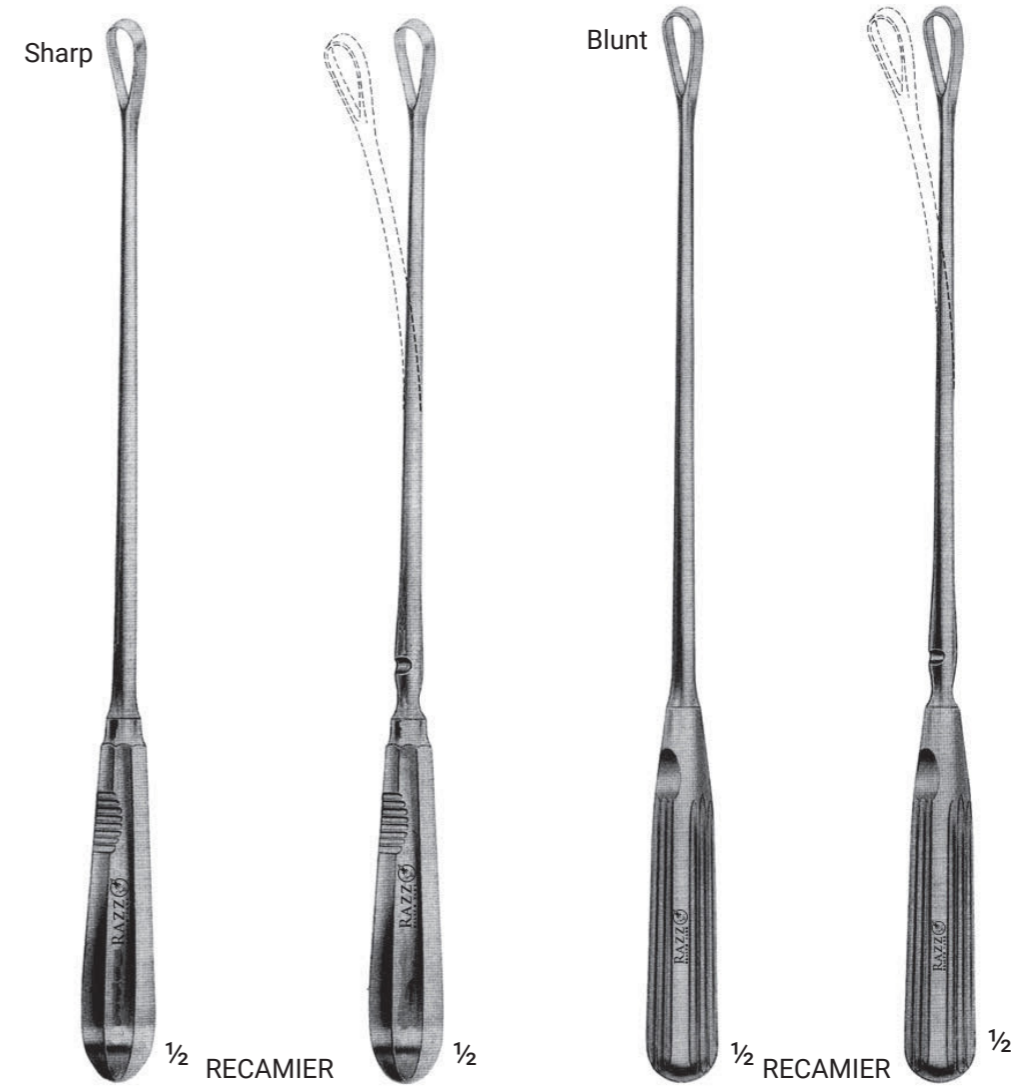

Rigid		Malleable		Rigid		Malleable	
RAO 15.00	- Fig 00 - 5mm	-	-	RAO 16.00	- Fig 00 - 5mm	-	-
RAO 15.10	- Fig 0 - 6mm	-	RAO 15.26	RAO 16.10	- Fig 0 - 6mm	-	RAO 17.26
RAO 15.11	- Fig 1 - 7mm	-	RAO 15.27	RAO 16.11	- Fig 1 - 7mm	-	RAO 17.27
RAO 15.12	- Fig 2 - 8mm	-	RAO 15.28	RAO 16.12	- Fig 2 - 8mm	-	RAO 17.28
RAO 15.13	Fig 3 - 9mm	-	RAO 15.29	RAO 16.13	Fig 3 - 9mm	-	RAO 17.29
RAO 15.14	Fig 4 - 11mm	-	RAO 15.31	RAO 16.14	- Fig 4 - 11mm	-	RAO 17.31
RAO 15.15	- Fig 5 - 12mm	-	RAO 15.32	RAO 16.15	- Fig 5 - 12mm	-	RAO 17.32
RAO 15.16	- Fig 6 - 14mm	-	RAO 15.34	RAO 16.16	- Fig 6 - 14mm	-	RAO 17.34
RAO 15.17	- Fig 7 - 15mm	-	RAO 15.35	RAO 16.17	- Fig 7 - 15mm	-	RAO 17.35
RAO 15.18	- Fig 8 - 16mm	-	RAO 15.36	RAO 16.18	- Fig 8 - 16mm	-	RAO 17.36
RAO 15.19	- Fig 9 - 19mm	-	RAO 15.39	RAO 16.19	- Fig 9 - 19mm	-	RAO 17.39
RAO 15.20	- Fig 10 - 20mm	-	RAO 15.40	RAO 16.20	- Fig 10 - 20mm	-	RAO 17.40
RAO 15.21	- Fig 11 - 21mm	-	RAO 15.41	RAO 16.21	- Fig 11 - 21mm	-	RAO 17.41
RAO 15.23	- Fig 12 - 23mm	-	RAO 15.43	RAO 16.23	- Fig 12 - 23mm	-	RAO 17.43
RAO 15.25	- Fig 13 - 25mm	-	RAO 15.45	RAO 16.25	- Fig 13 - 25mm	-	RAO 17.45
RAO 60.30	- Fig 14 - 30mm	-	RAO 61.50	RAO 62.30	- Fig 14 - 30mm	-	RAO 63.50
RAO 60.35	- Fig 15 - 35mm	-	RAO 61.55	RAO 62.35	- Fig 15 - 35mm	-	RAO 63.55
RAO 60.40	- Fig 16 - 40mm	-	RAO 61.60	RAO 62.40	- Fig 16 - 40mm	-	RAO 63.60

UTERINE CURETTES

UTERINE PROBES

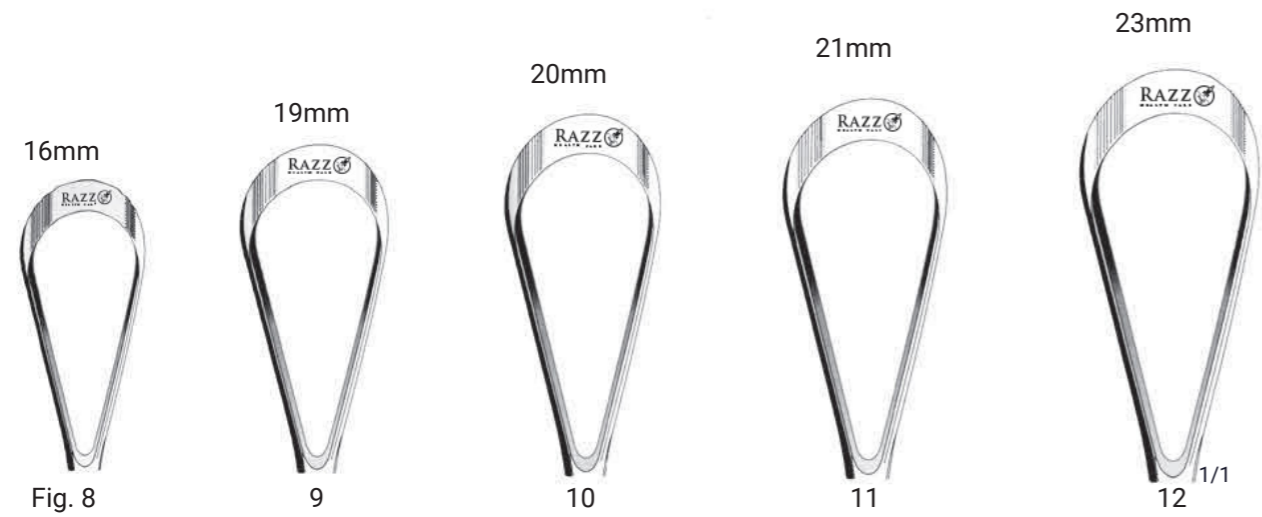
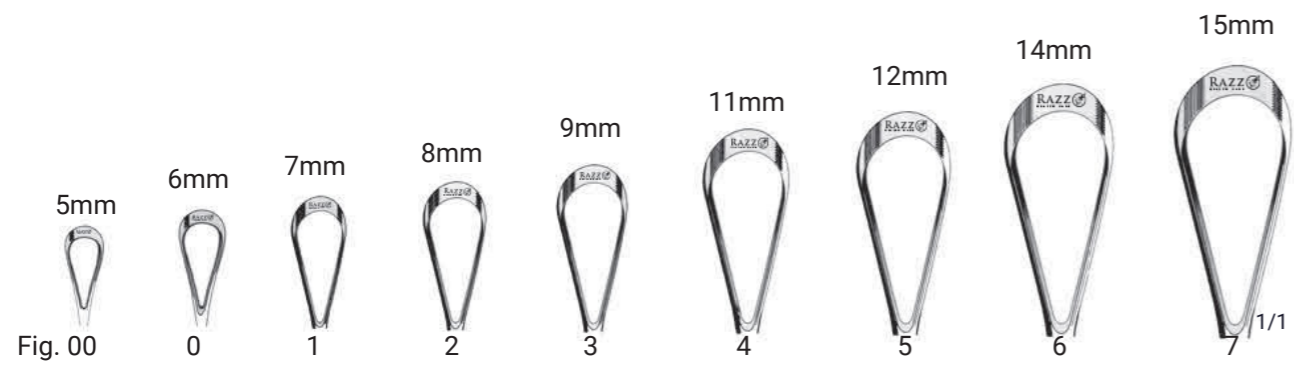

RECAMIER - SIMS



MAYO UTERINE PROBE MALLEABLE STRAIGHT 330mm/13 1/4" RAO 49.33	SIMS UTERINE PROBE MALLEABLE CURVED 330mm/13 1/4" RAO 49.31	MARTIN UTERINE PROBE MALLEABLE CURVED 300mm/12" RAO 49.35	SIMSPSON UTERINE PROBE MALLEABLE ANGLED 330mm/13 1/4" RAO 49.37	SIMSPSON UTERINE PROBE MALLEABLE SLIGHTLY CURVED 290mm/11 3/4" RAO 49.39
--	--	--	--	---

UTERINE DILATORS

UTERINE DILATORS



HEGAR
200mm / 8"
RAO 38.00 - Set of 26
RAO 39.00 - Set of 20

With Sloped Handle	
mm ø	
1	RAO 38.01
2	RAO 38.02
3	RAO 38.03
4	RAO 38.04
5	RAO 38.05
6	RAO 38.06
7	RAO 38.07
8	RAO 38.08
9	RAO 38.09
10	RAO 38.10
11	RAO 38.11
12	RAO 38.12
13	RAO 38.13
14	RAO 38.14
15	RAO 38.15
16	RAO 38.16
17	RAO 38.17
18	RAO 38.18
19	RAO 38.19
20	RAO 38.20
21	RAO 38.21
22	RAO 38.22
23	RAO 38.23
24	RAO 38.24
25	RAO 38.25
26	RAO 38.26

RAO 38.01 - RAO 38.26

With Sloped Handle	
mm ø	
1.5	RAO 39.01
2.5	RAO 39.02
3.5	RAO 39.03
4.5	RAO 39.04
5.5	RAO 39.05
6.5	RAO 39.06
7.5	RAO 39.07
8.5	RAO 39.08
9.5	RAO 39.09
10.5	RAO 39.10
11.5	RAO 39.11
12.5	RAO 39.12
13.5	RAO 39.13
14.5	RAO 39.14
15.5	RAO 39.15
16.5	RAO 39.16
17.5	RAO 39.17
18.5	RAO 39.18
19.5	RAO 39.19
20.5	RAO 39.20

RAO 39.01 - RAO 39.20

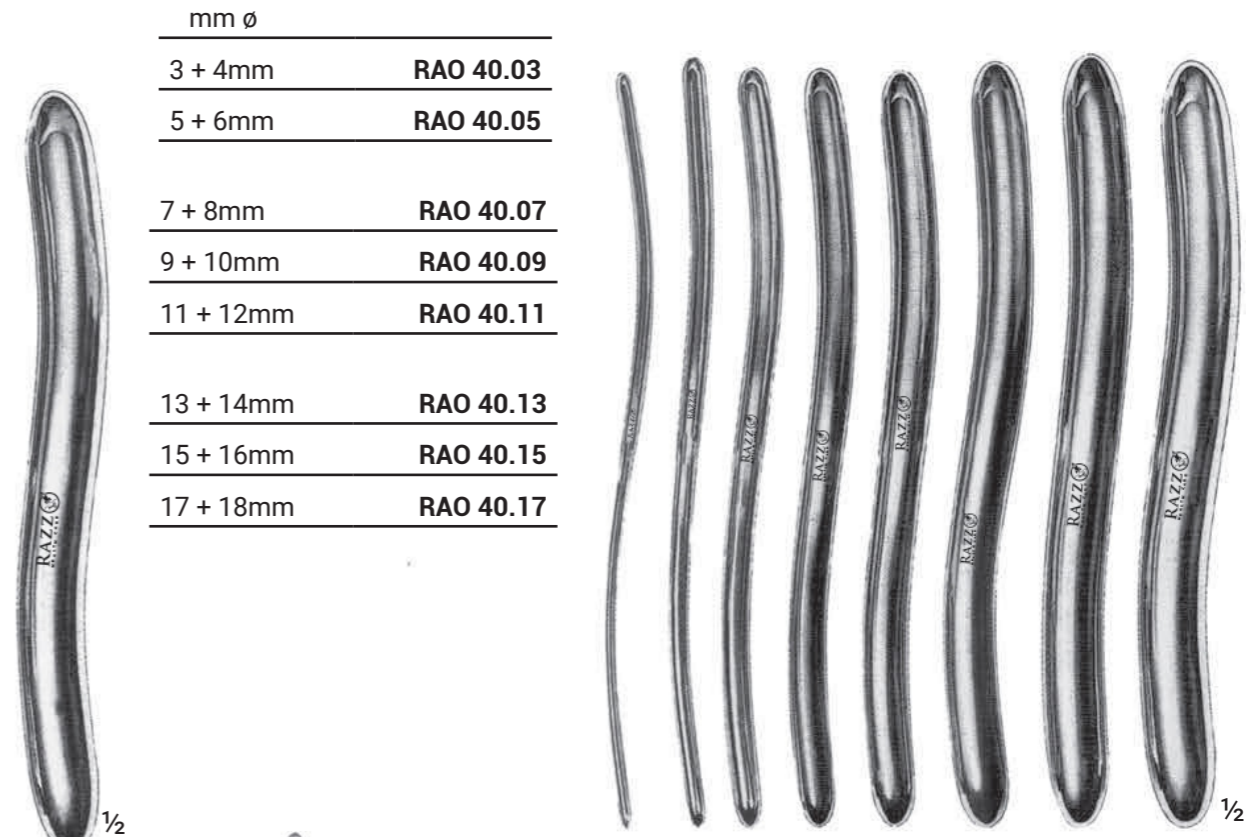

HEGAR
DOUBLE ENDED
SET OF 8 DILATORS
RAO 40.00
200MM/8"

mm ø	
3 + 4mm	RAO 40.03
5 + 6mm	RAO 40.05
7 + 8mm	RAO 40.07
9 + 10mm	RAO 40.09
11 + 12mm	RAO 40.11
13 + 14mm	RAO 40.13
15 + 16mm	RAO 40.15
17 + 18mm	RAO 40.17

HEGAR
DOUBLE ENDED
SLENDER TYPE
205mm / 8"
RAO 41.01

RAO 41.03
1.0 x 1.5mm
RAO 41.04
2.0 x 2.5mm
RAO 41.05
3.0 x 3.5mm
RAO 41.06
4.0 x 4.5mm
RAO 41.07
5.0 x 5.5mm
RAO 41.08
6.0 x 6.5mm
RAO 41.09
7.0 x 7.5mm
RAO 41.10
8.0 x 8.5mm
RAO 41.11
9.0 x 9.5mm
RAO 41.12
10.0 x 10.5mm

RAO 40.03 - RAO 40.17

RAO 41.03 - RAO 41.12

EPISIOTOMY & UMBILICAL CORD SCISSORS

PELVIMETRE, AMNIOTOME, SCALP FLAP & OBSTETRICAL FORCEPS

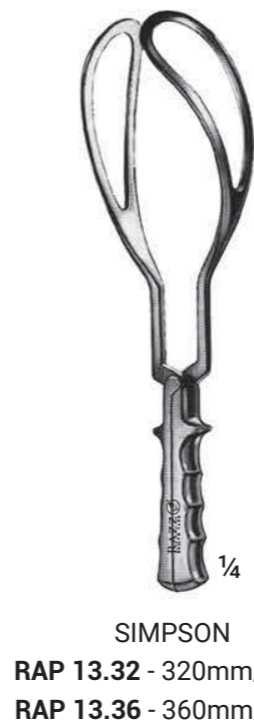
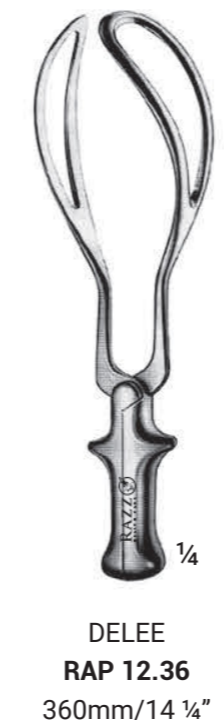
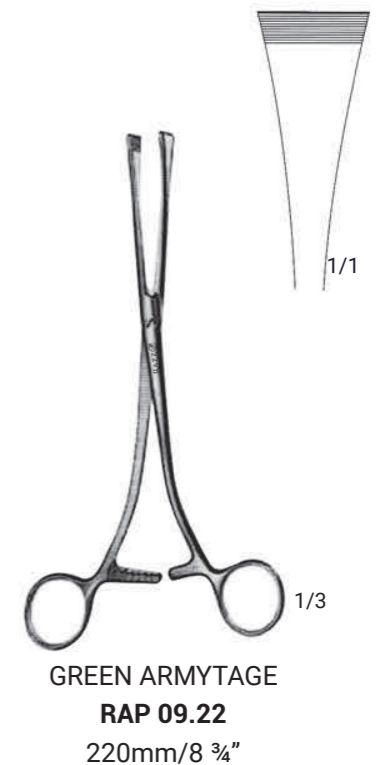
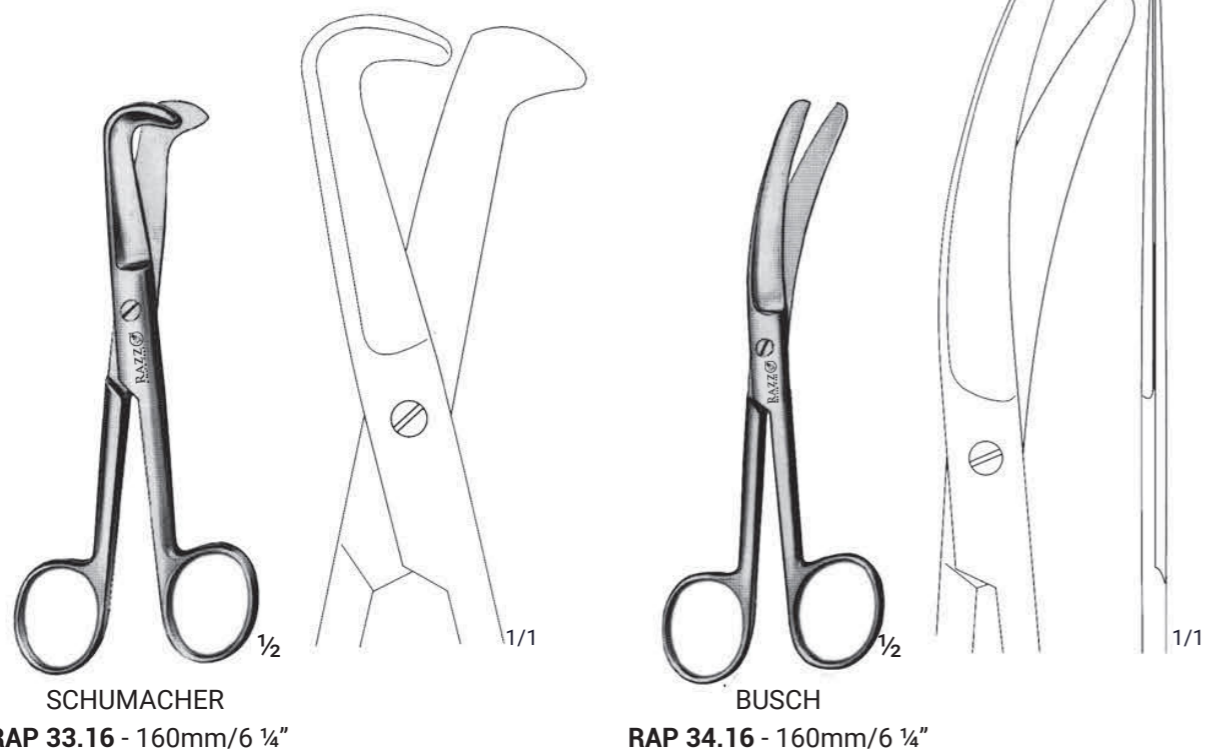
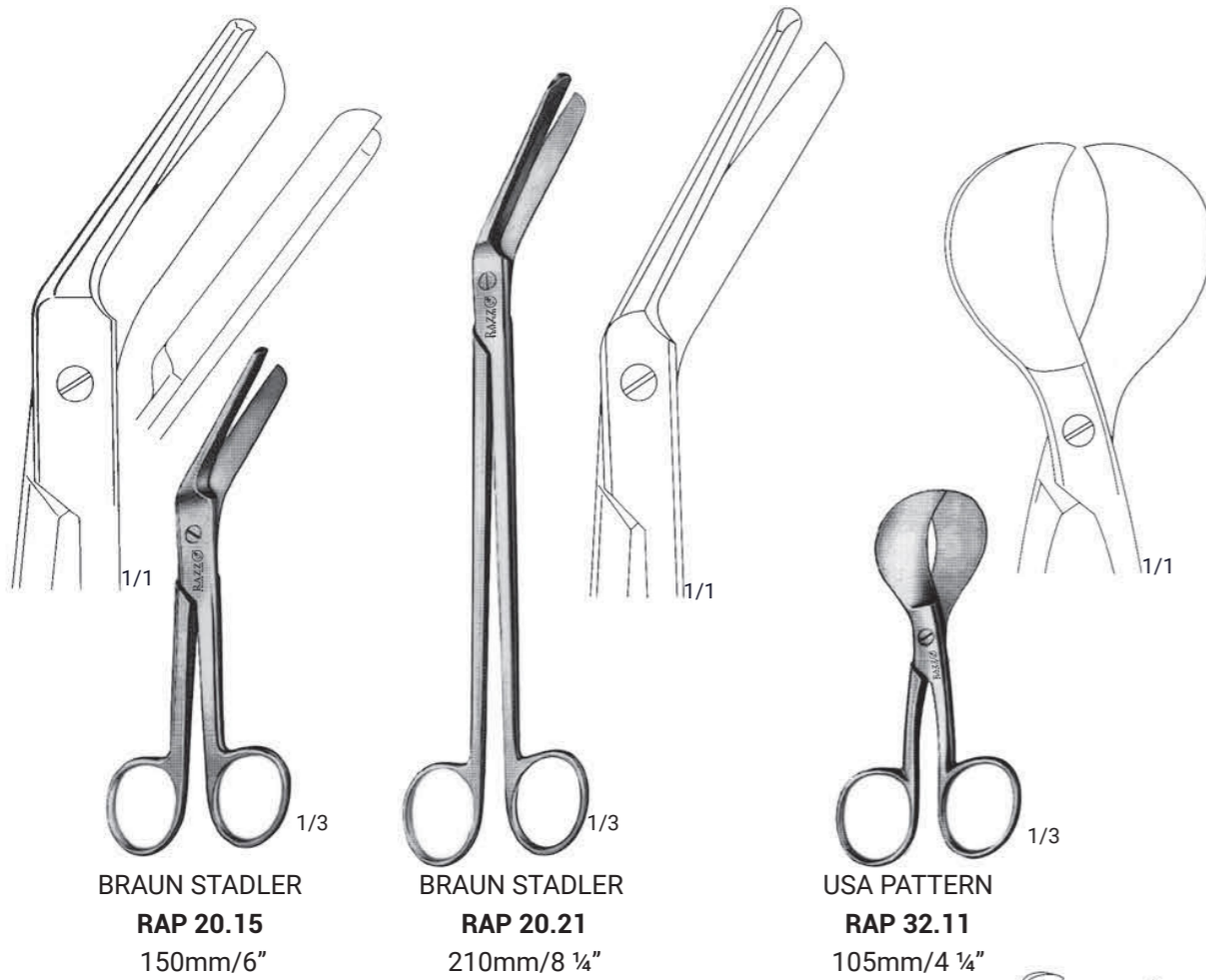

OBSTETRICAL FORCEPS



MILNE MURRAY
MIDWIFERY FORCEPS
DETACHABLE AXIS TRACTION
RODS & HANDLE
380mm/15"
RAP 23.50



WRIGLEY
OBSTETRICAL FORCEPS
250mm/10"
RAP 23.60



BRAUN
OBSTETRICAL FORCEPS
305mm/12"
RAP 23.70



UROLOGY INSTRUMENTS

BOOKWALTER RETRACTOR

Ring Sizes

Small
203mm x 311
RAJ 60.25

Medium
267mm x 368
RAJ 60.26

Large
300mm x 470
RAJ 60.27

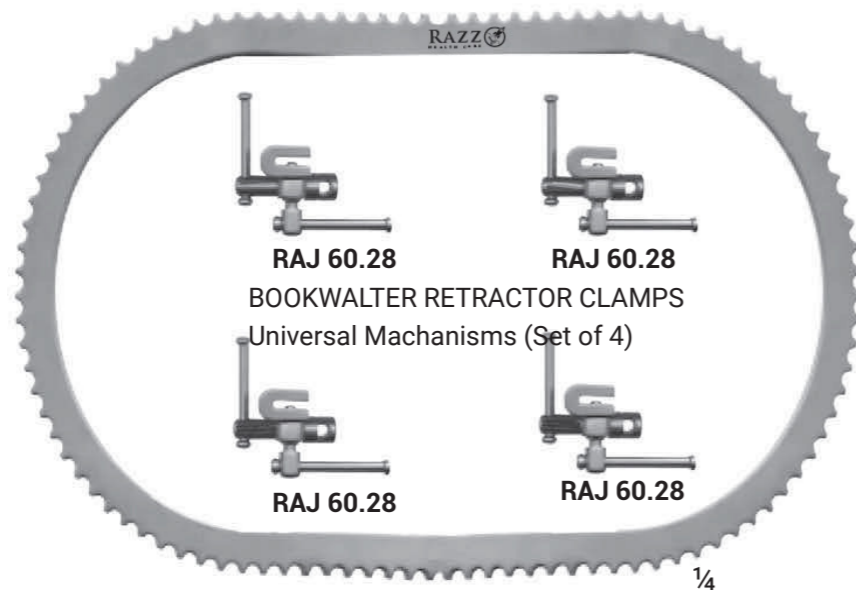

BOOKWALTER RETRACTOR (Oval Ring)

BOOKWALTER RETRACTOR



BOOKWALTER
Malleable Retractor
Blade Width - 38mm
Blade Height - 150mm
Total Length - 310mm

RAJ 60.34



MALLEABLE
RETRACTOR
Blade Width - 50mm
Blade Height - 150mm
Total Length - 310mm

RAJ 60.36



MALLEABLE
RETRACTOR
Blade Width - 75mm
Blade Height - 150mm
Total Length - 310mm

RAJ 60.38



RAJ 60.30-Horizontal Flex Bar



RAJ 60.31 -Table Post



RAJ 60.32 - Post Coupling



BALFOUR
RETRACTOR
Blade Width - 70mm
Blade Depth - 85mm

RAJ 60.40



HARRINGTON
RETRACTOR
Blade Width - 68mm
Blade Depth - 145mm

RAJ 60.42

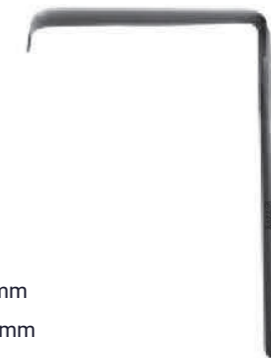

KELLY
RETRACTOR
50mm X 75

RAJ 60.44

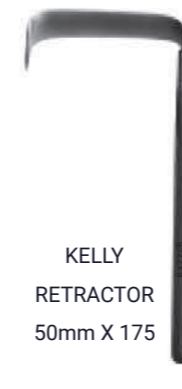

KELLY
RETRACTOR
50mm X 175

RAJ 60.52



KELLY
RETRACTOR
50mm X 150

RAJ 60.50

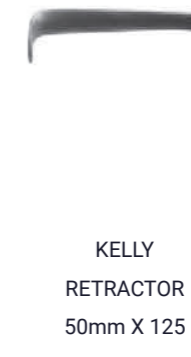

KELLY
RETRACTOR
50mm X 125

RAJ 60.48



KELLY
RETRACTOR
50mm X 100

RAJ 60.46



French

6/10

8/12

10/14

12/16

14/18

16/20

18/22

20/24

22/26

24/28

26/30

28/32

1/2

CLUTTON
270mm/10 1/2"
RAJ 07.10



English
0/2 - STD

1 - CVD

1/2 / 3 -

1 / 4 -

2 / 5 -

3 / 6 -

4 / 7 -

5 / 8 -

6 / 9 -

7 / 10 -

8 / 11 -

9 / 12 -

1/3

LISTERS
280mm/10 3/4"
RAJ 07.30



GUYON
RAJ 08.20
360mm/14 1/4"



GUYON
RAJ 09.30
360mm/14 1/4"



DITTEL
RAJ 10.60
390mm/15 1/2"



RAJ 11.70
390mm/15 1/2"

BLADDER RETRACTORS



MILLIN
BLADDER
210mm/8 1/4"
RAJ 20.80

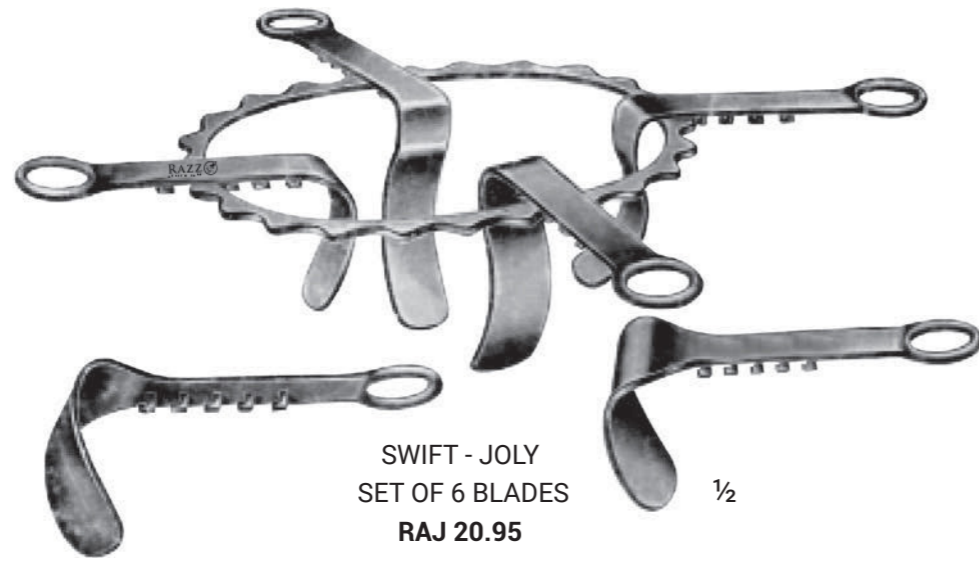

SWIFT - JOLY
SET OF 6 BLADES
RAJ 20.95



LEGUEU
RAJ 16.16
270mm/10 1/2"

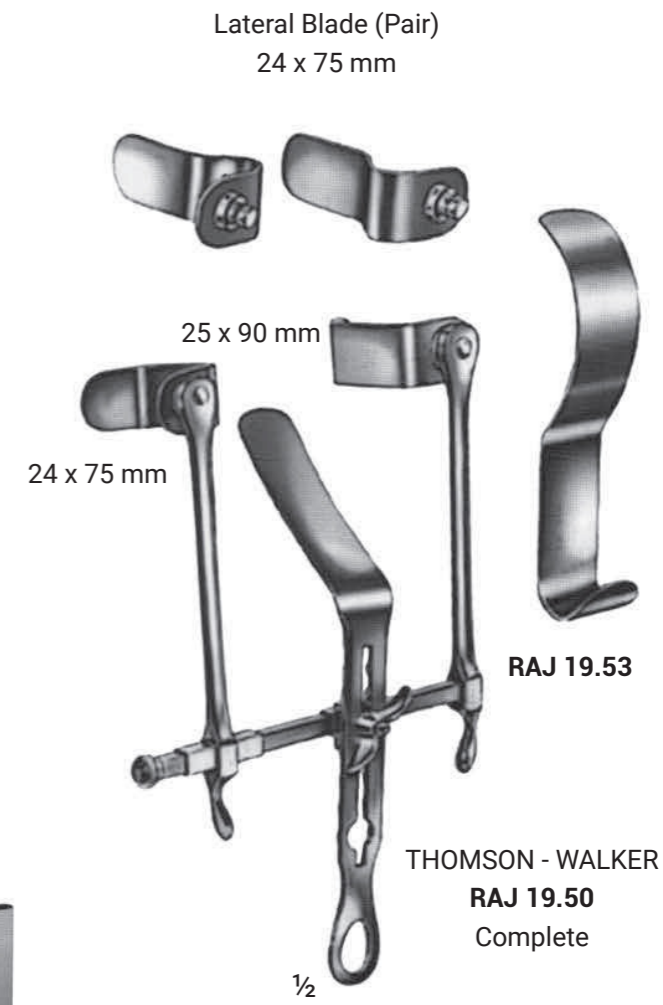

THOMSON - WALKER
RAJ 19.50
Complete

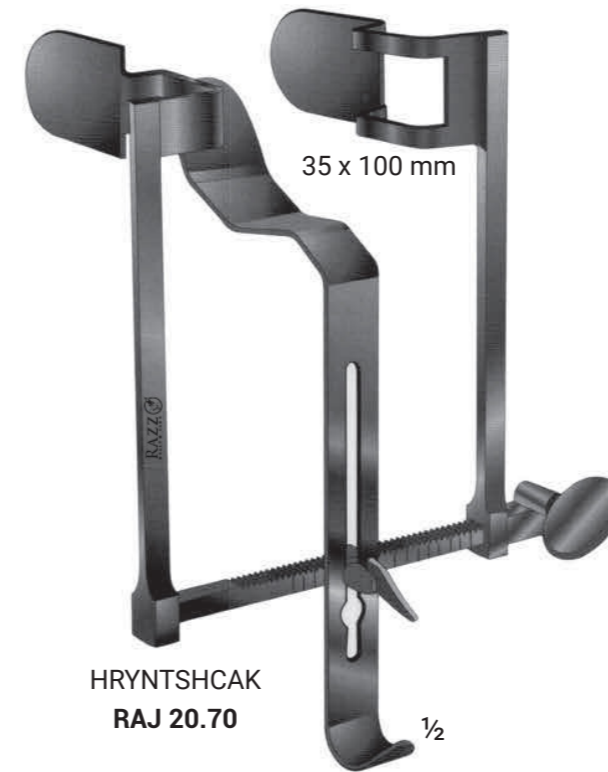

HRYNTSHCAK
RAJ 20.70

BLADDER SPATULA & RETRACTORS

PROSTATIC RETRACTORS & INSTRUMENTS

KIDNEY PEDICLE CLAMPS

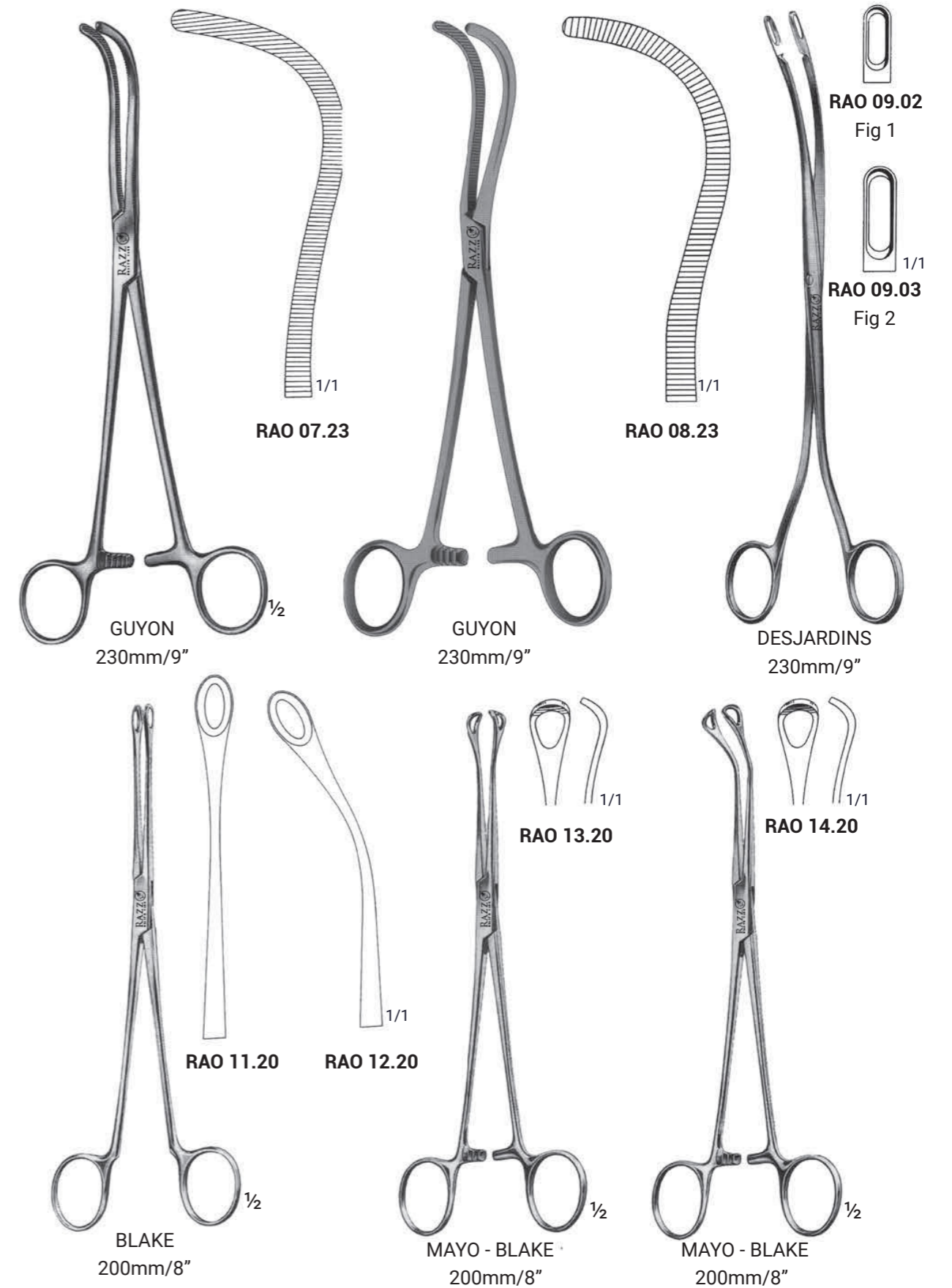
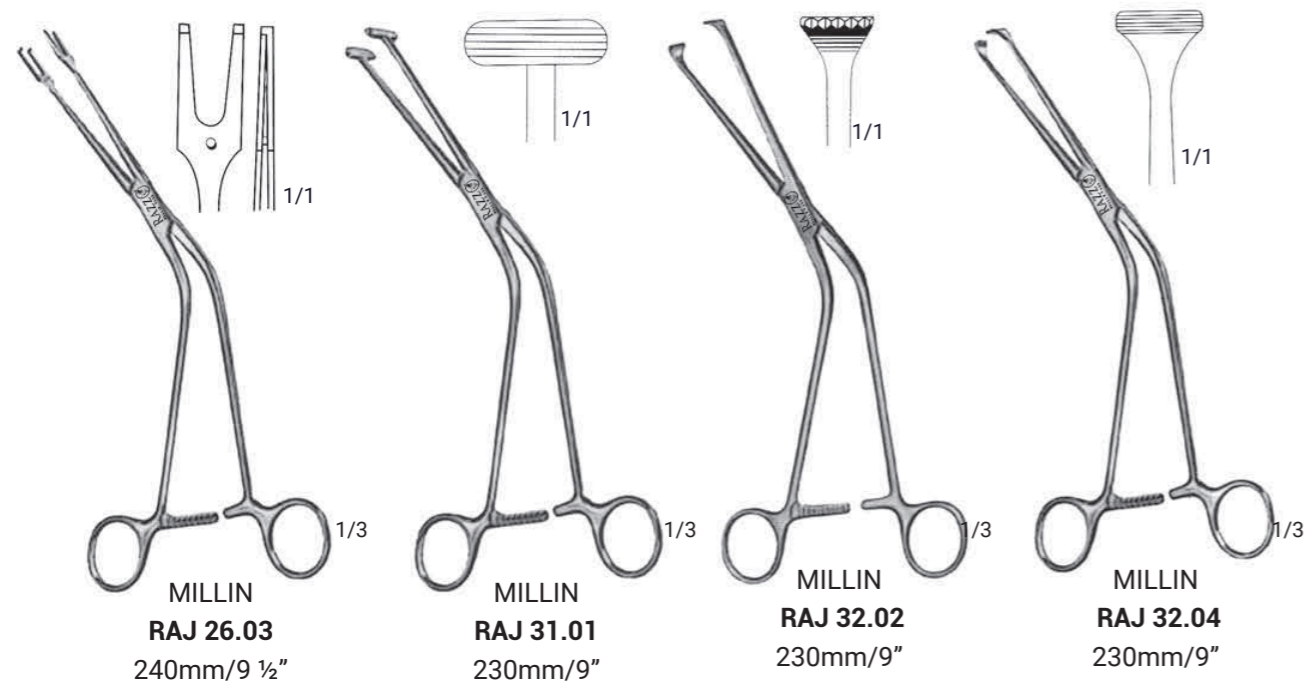
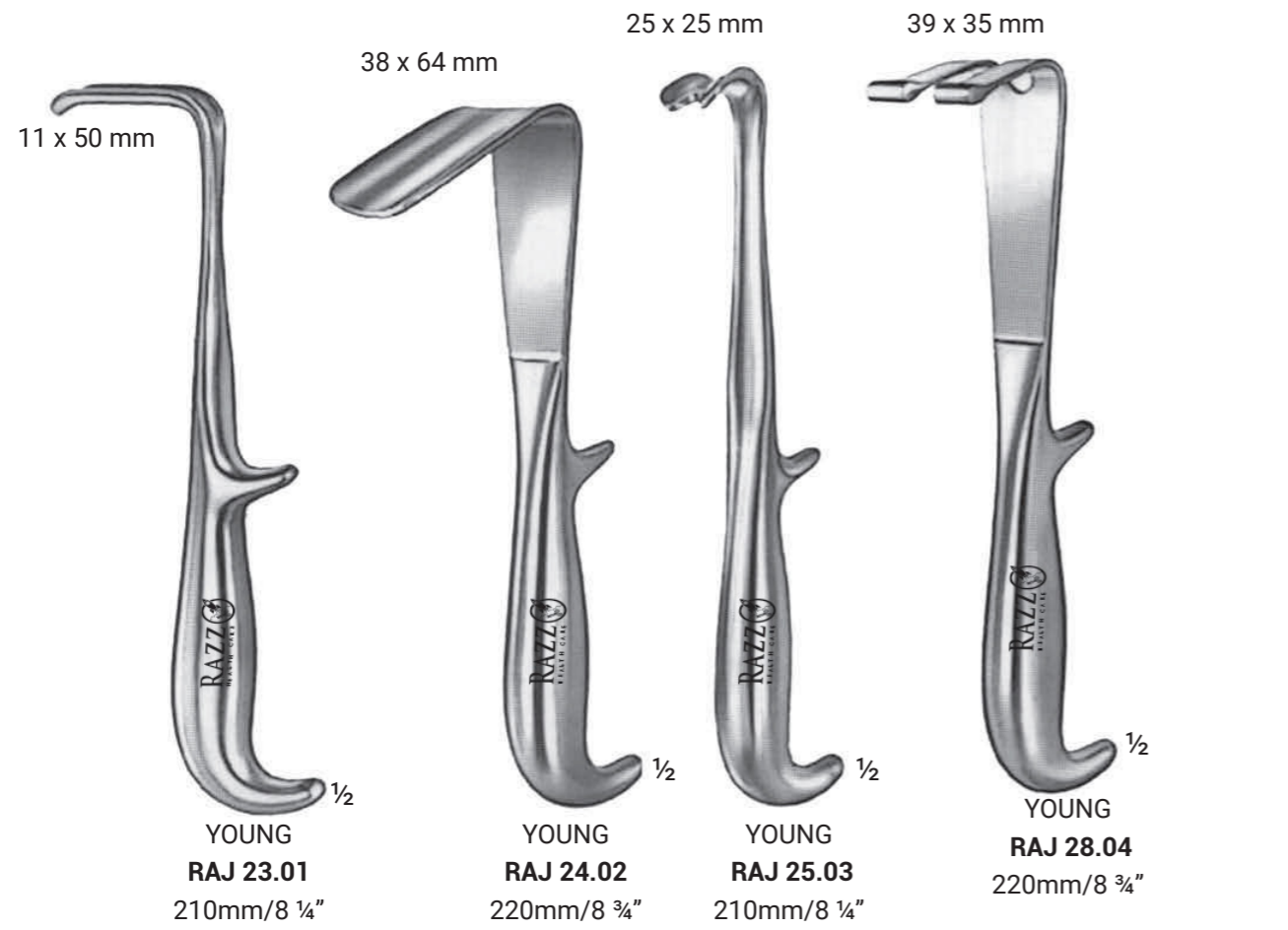

KIDNEY PEDICLE CLAMPS & VAGINAL FORCEPS

GALL BLADDER SCISSORS, PROBES & DILATORS

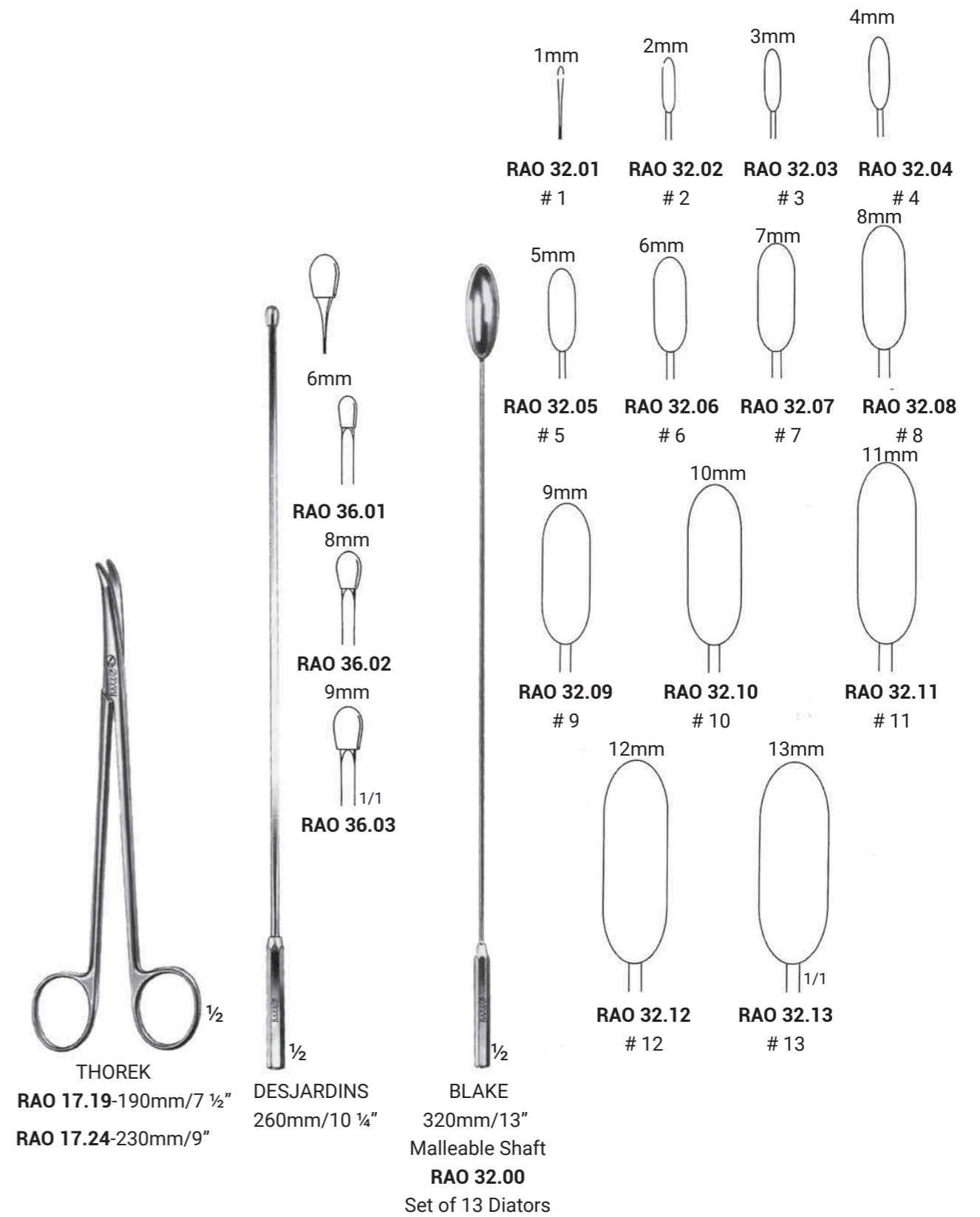

BLADDER NECK SPREADER, MEATUS CLAMPS & FOREIGN BODY FORCEPS

TROCARS / DILATOR



MILLIN
RAJ 33.50
280mm/11"



STRAUSS
RAJ 04.10
120mm/4 3/4"



STOCKMANN
RAJ 05.05
80mm 3/1/8"

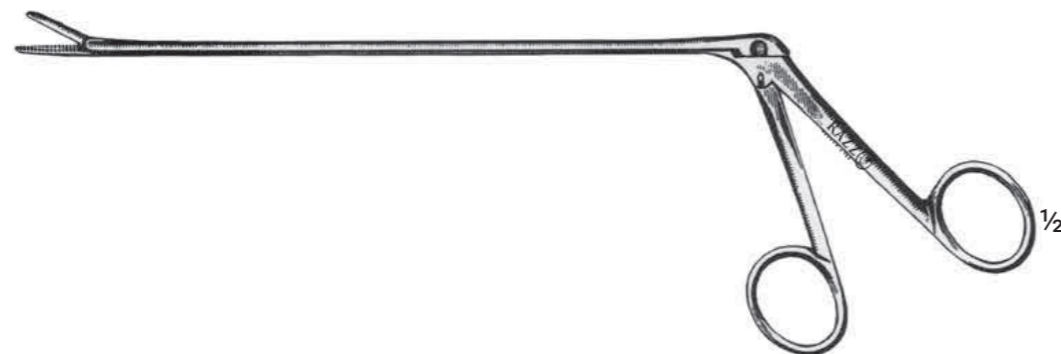

MATHIEU
RAJ 21.27 - 200mm/8"
RAJ 21.28 - 280mm/11"



SUPRAPUBIC
TROCAR & CANNULA
WITHOUT GROOVE
210mm/8 1/4"
RAO 20.61 - RAO 20.64

SUPRAPUBIC
TROCAR & CANNULA
WITH GROOVE
210mm/8 1/4"
RAO 21.61 - RAO 21.64



TURNER WARWICK
RETROGRADE BOEGIE
180mm/7"
RAO 21.70

KIDNEY STONE FORCEPS

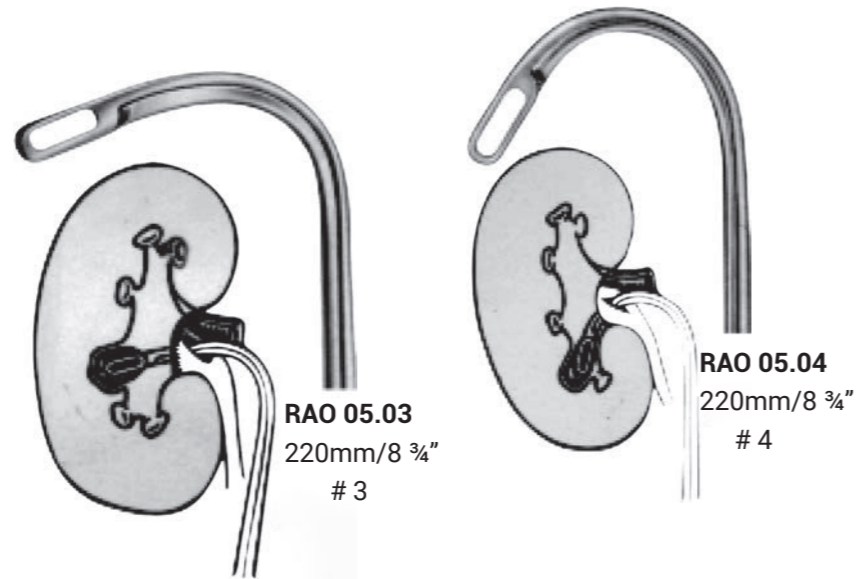
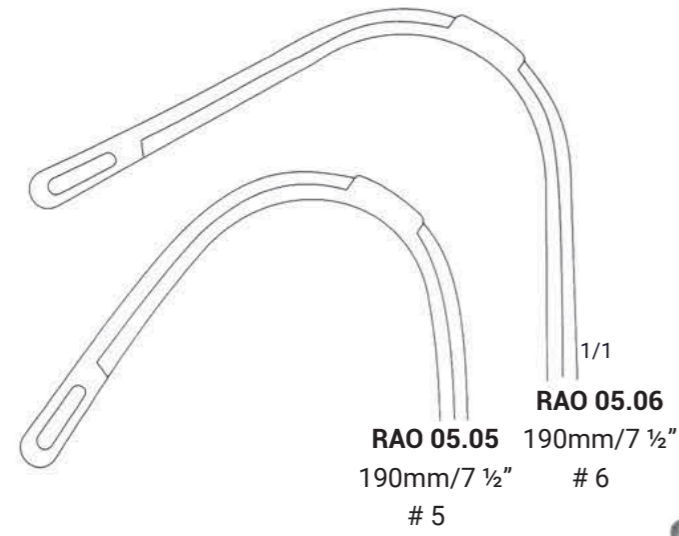

RANDALL
 RAO 05.01 - RAO 05.06 1/2

REVERDIN NEEDLES

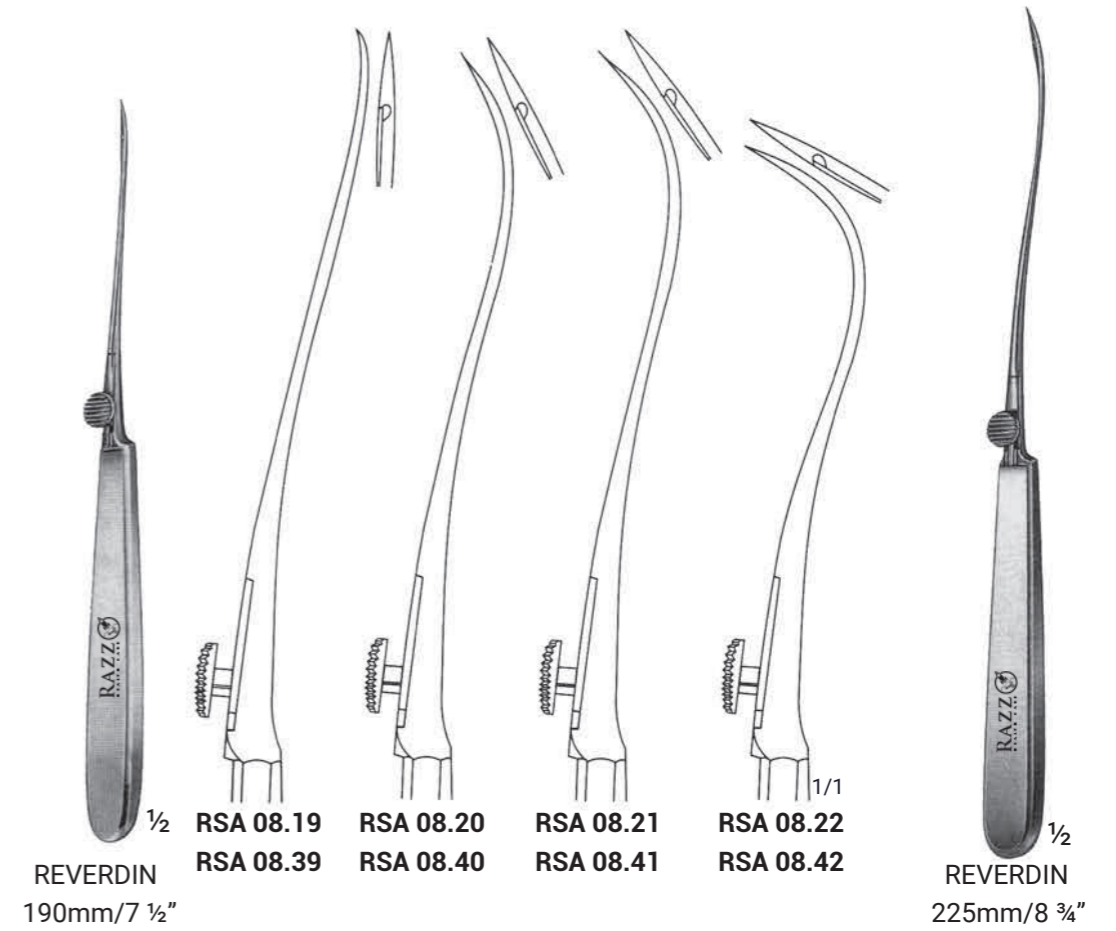
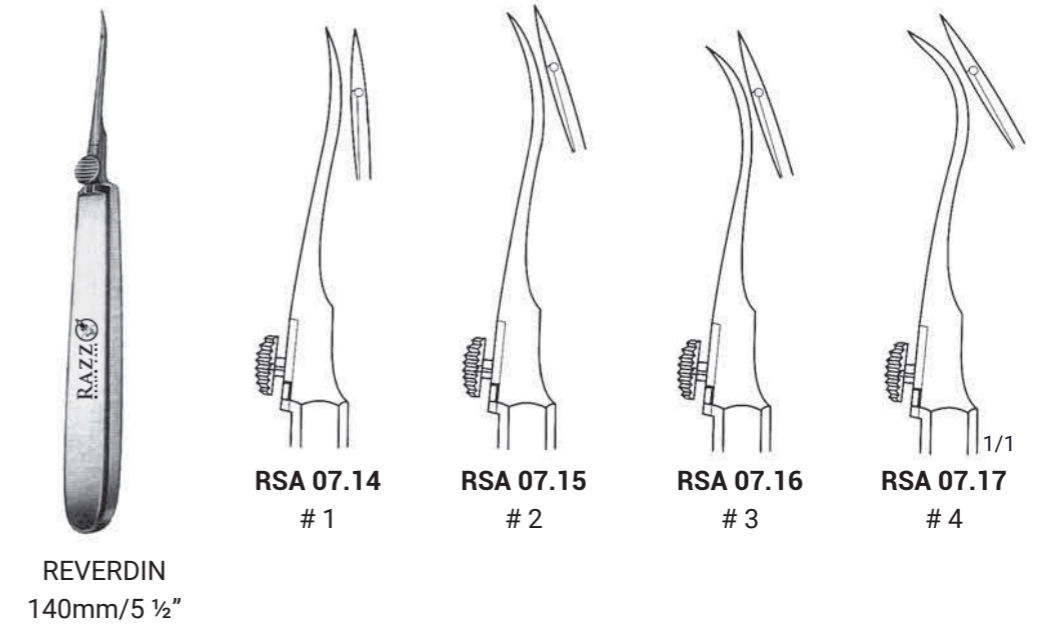

BLADDER RETRACTOR / LIGATURE NEEDLES

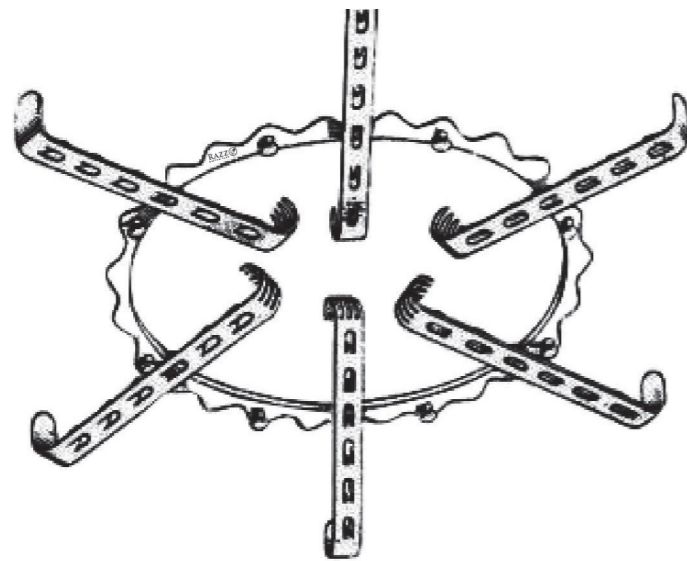

TURNER-WARWICK
BLADDER RETRACTOR
OVAL FRAME 180mm x 140mm
WITH 6 BLADES 4 PRONGS
RSA 08.60

TURNER-WARWICK
URETHROPLASTY NEEDLES
RSA 08.50 - RSA 08.52
195mm/7 3/4"

RSA 08.53
SET OF 3



RSA 08.50



RSA 08.51



RSA 08.52

VASECTOMY / GALL BLADDER FORCEPS



VASECTOMY
DISSECTION
125mm/5"
RAO 14.40



VASECTOMY
FIXATION
RING Ø 4.8mm
140mm/5 1/2"
RAO 14.45



HERNIA RING FORCEP
150mm/6"
RAO 14.50



HERNIA BISTOURY
180mm/7"
RAO 14.55

PROCTOSCOPES, ANOSCOPES & SPHINCTEROSCOPES

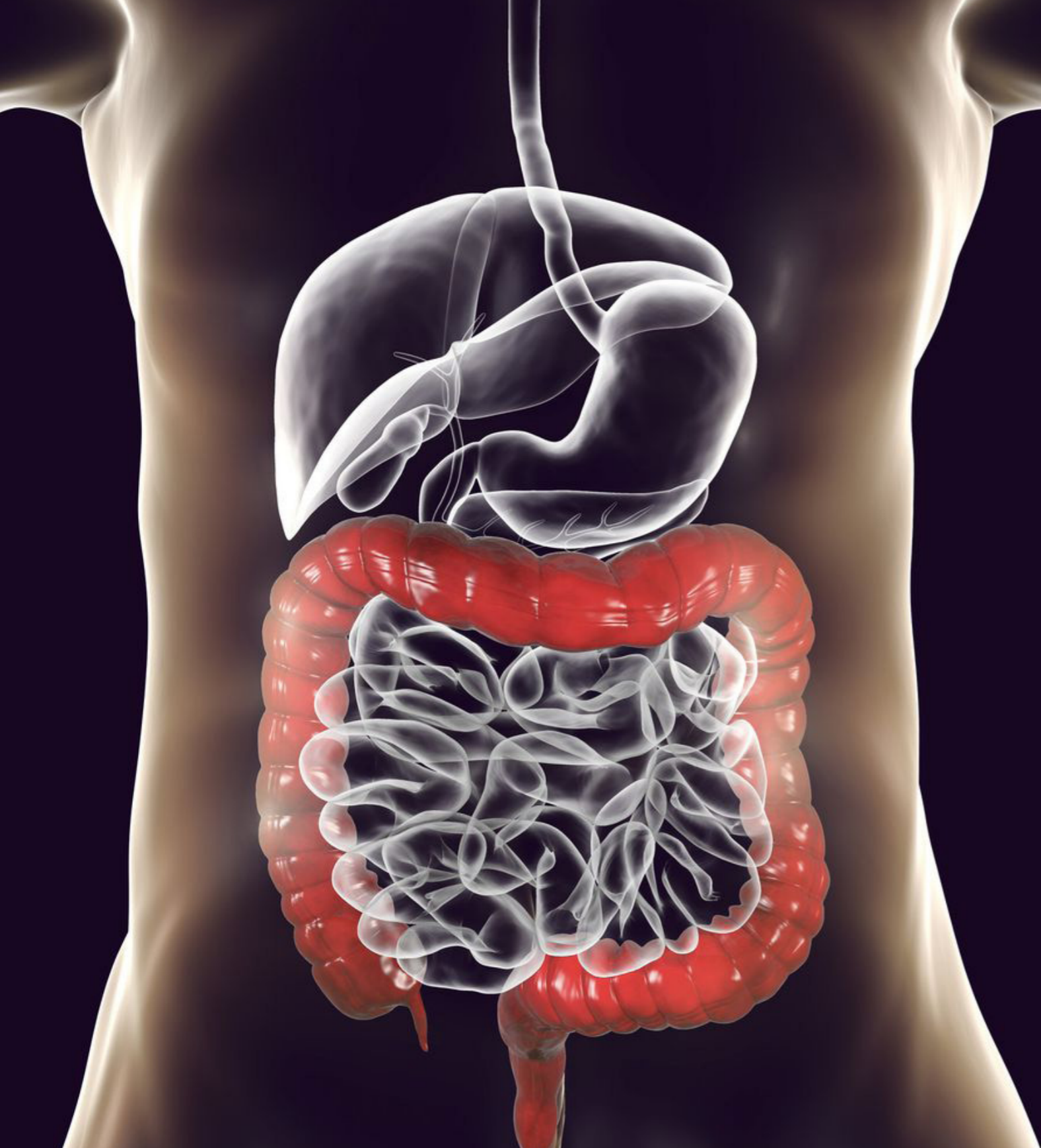

INTESTINAL & RECTAL



HIRSCHMANN
RAN 64.16 - Ø 16mm x 60mm
RAN 64.19 - Ø 19mm x 70mm
RAN 64.22 - Ø 22mm x 90mm



KELLY
RAN 61.21 - Ø 21mm x 50mm
RAN 61.25 - Ø 25mm x 50mm

RAN 62.23 - Ø 23mm x 145mm
RAN 62.24 - Ø 23mm x 205mm



NEWMAN
RAN 63.01 - Ø 16mm x 63mm
RAN 63.02 - Ø 19mm x 63mm
RAN 63.03 - Ø 23mm x 63mm

RECTAL SPECULA



SIMS
RAN 52.16 - 160mm/6 1/4"



SIMS
RAN 53.16 - 160mm/6 1/4"



3 Blades
MATHIEU
RAN 58.21 - 210mm/8 1/4"

BIOPSY FORCEPS

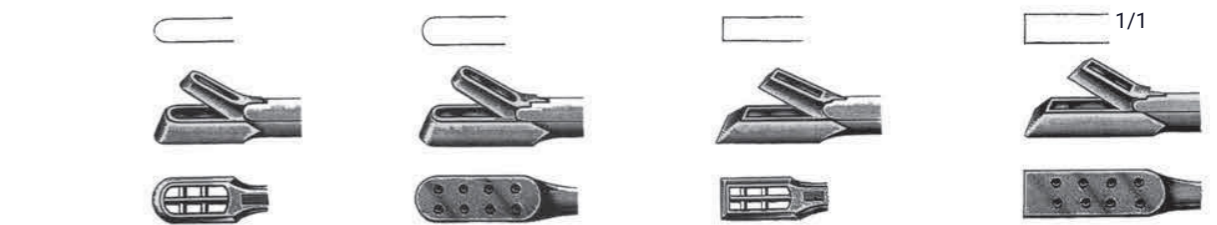
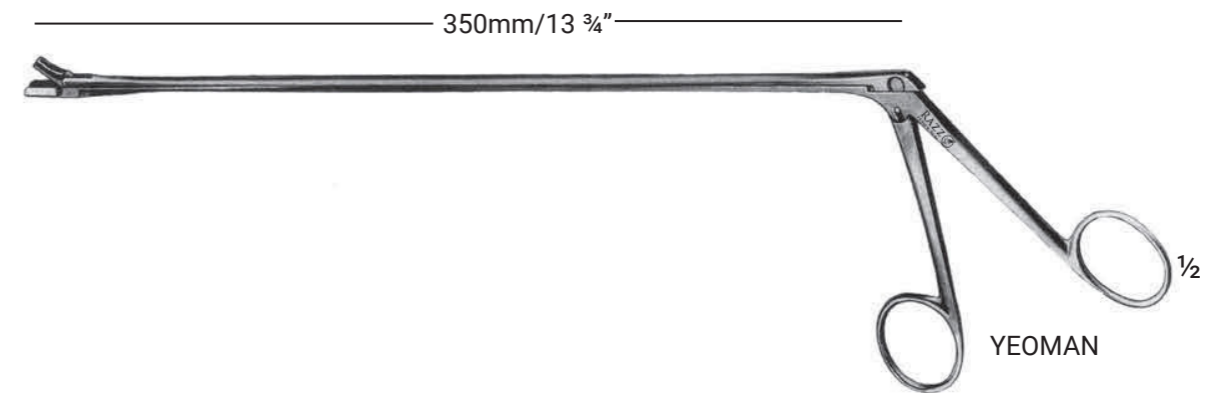
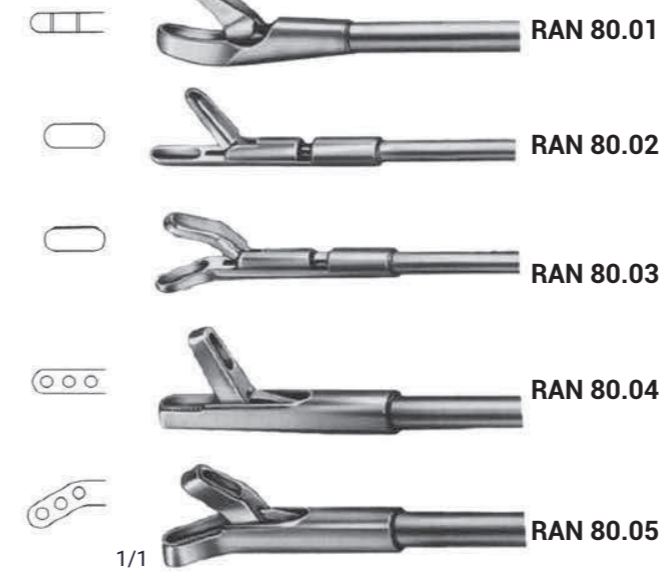
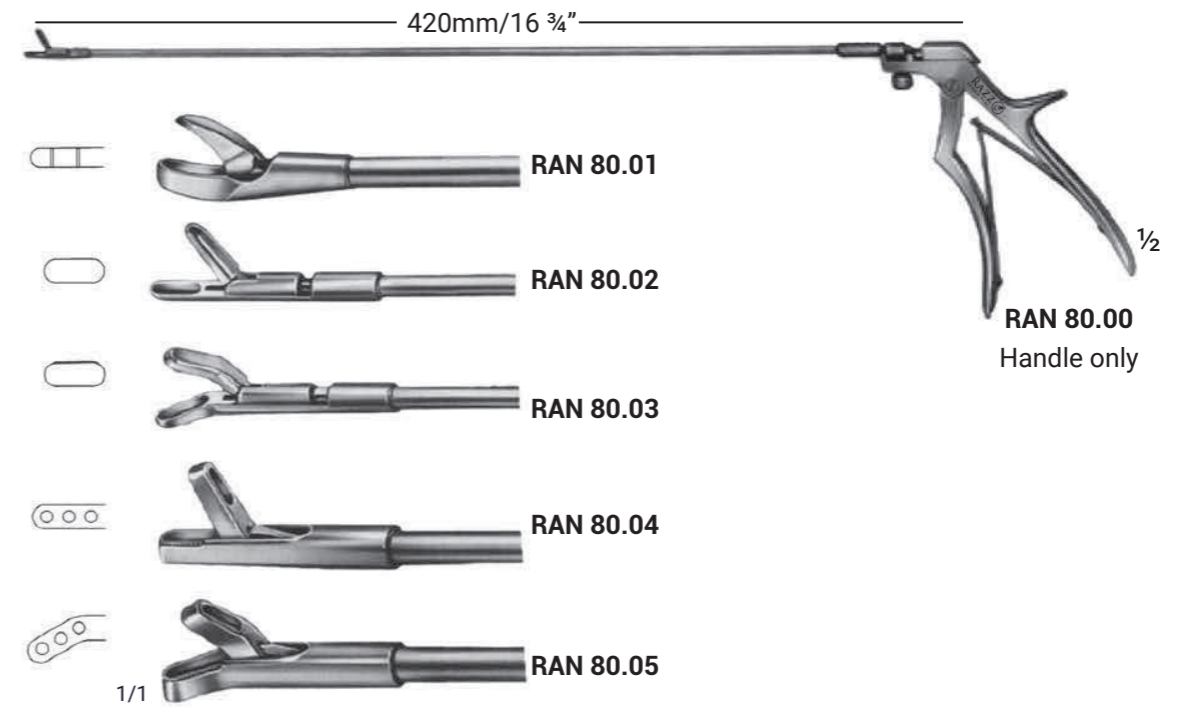

Shaft Length	RAN 86.18	RAN 86.28	RAN 86.35	RAN 86.43	RAN 95.18	RAN 95.25	RAN 95.28	RAN 95.33	RAN 95.35	RAN 95.43
280mm/11"										
350mm/13 3/4"										
430mm/17"										

INTESTINAL CLAMP FORCEPS

INTESTINAL CLAMP FORCEPS

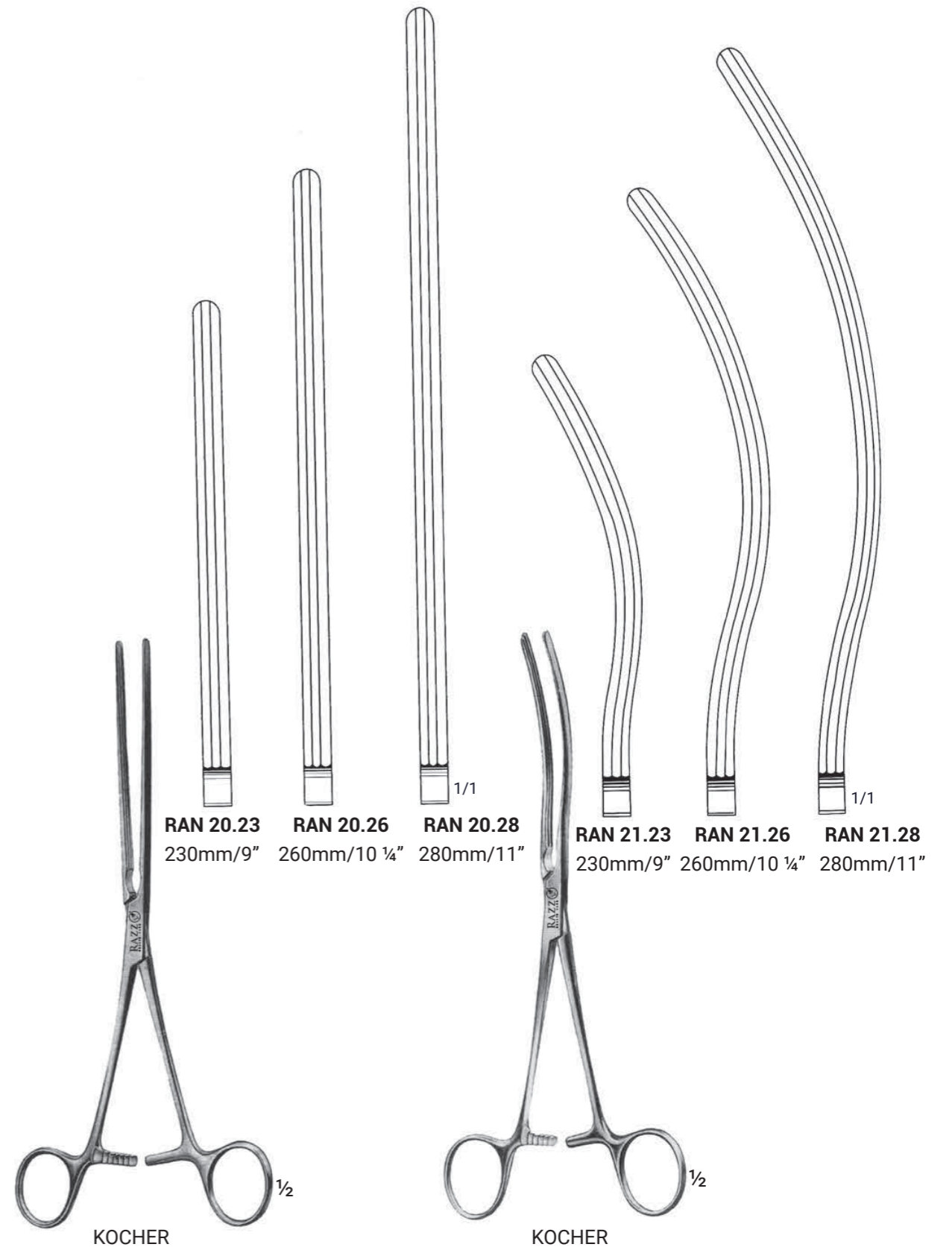
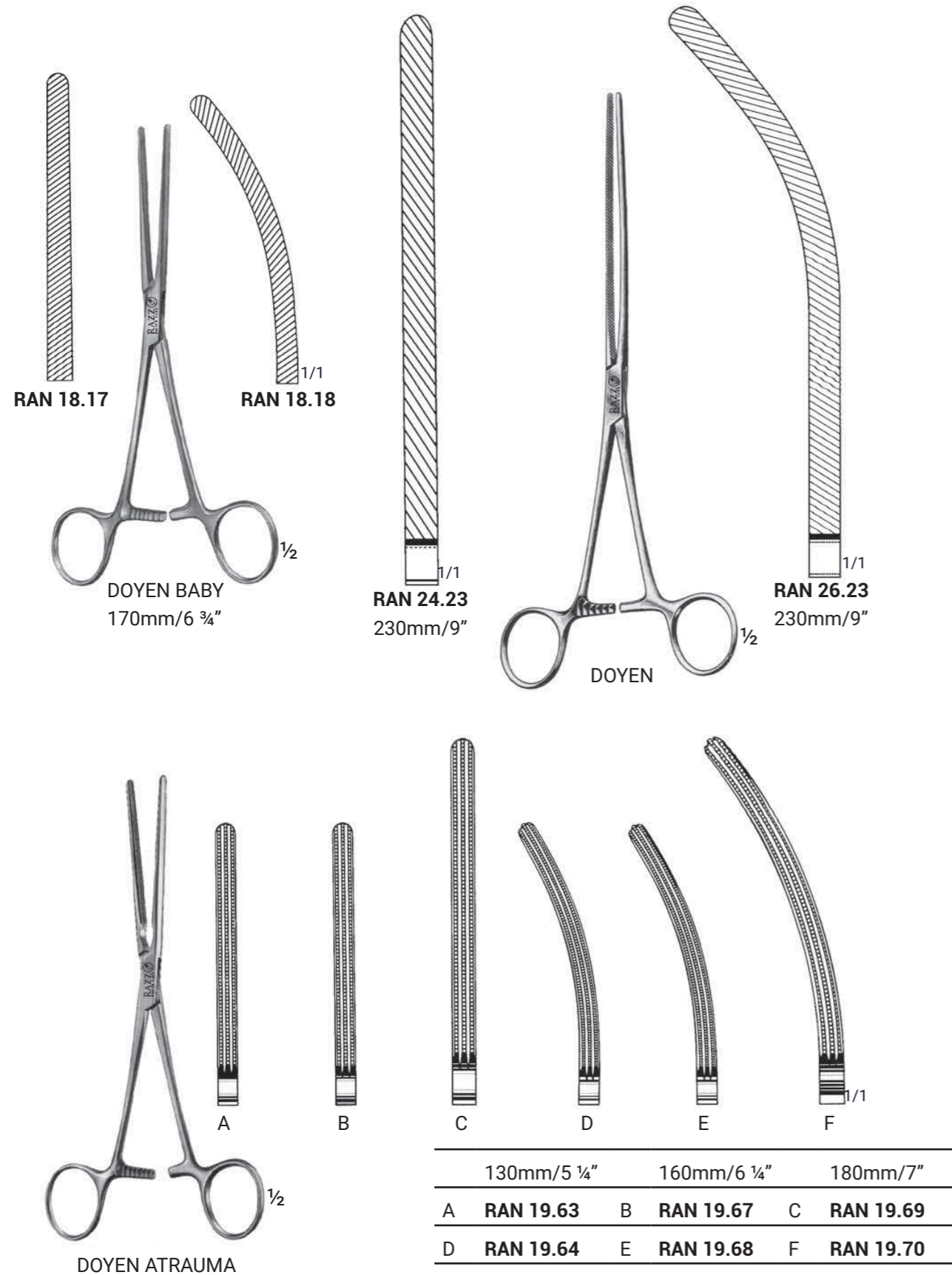

ATRAUMATIC CLAMP FORCEPS

ATRAUMATIC CLAMP FORCEPS

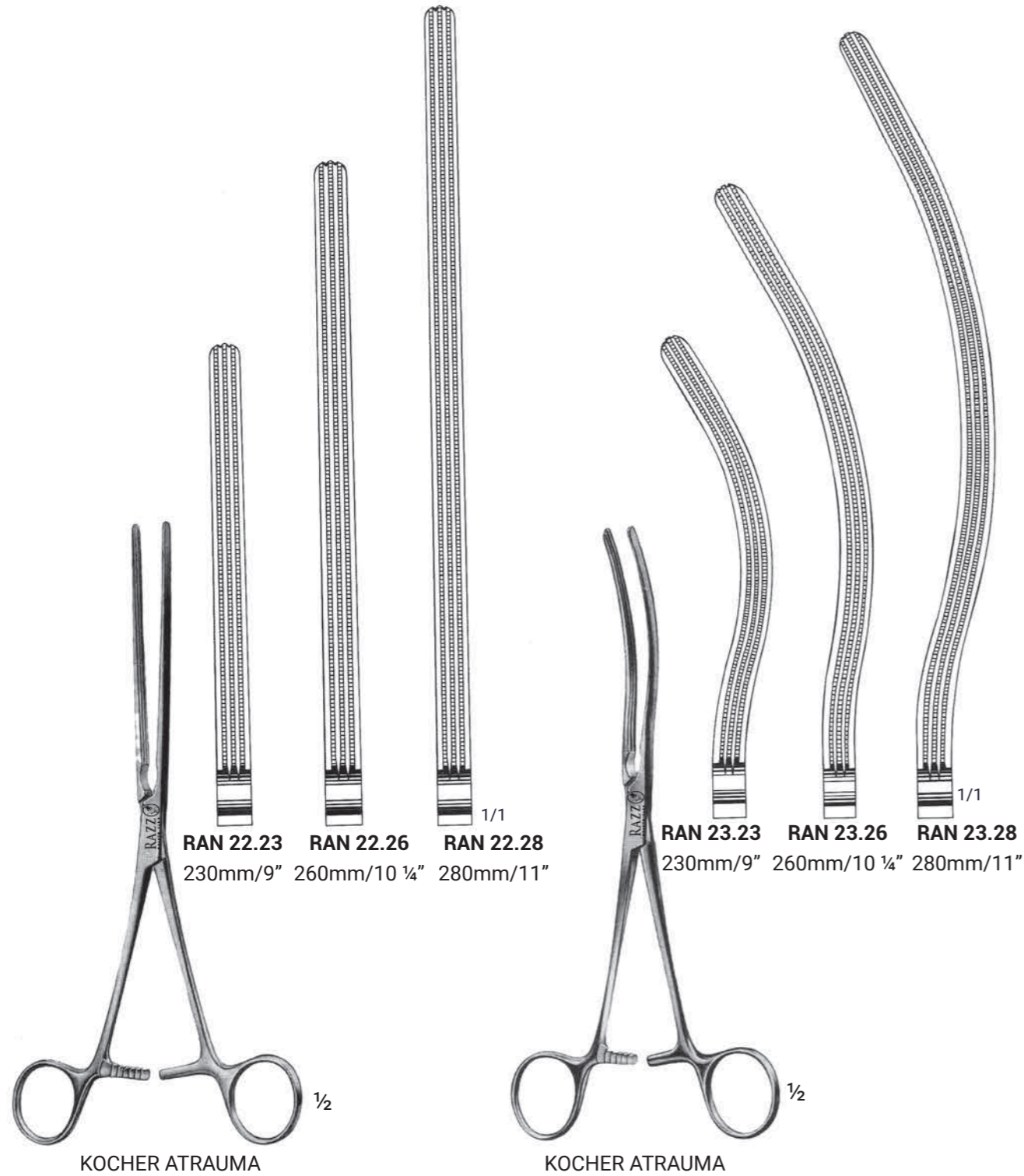

INTESTINAL & STOMACH CLAMPS

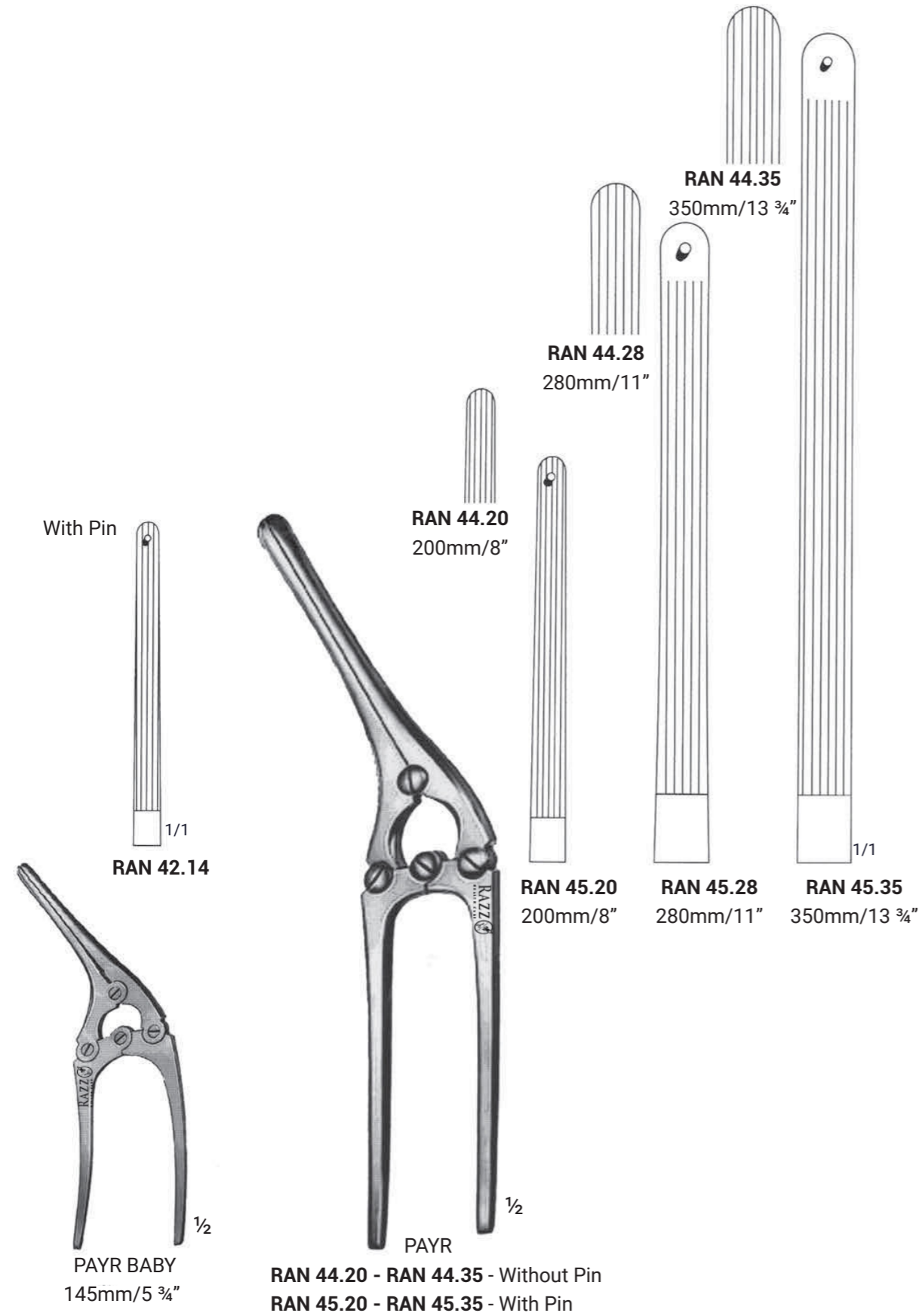

GALL BLADDER / RECTAL

HAEMORRHOIDAL LIGATING FORCEPS



HAEMMORRHOIDAL
LIGATING FORCEPS WITH GUN
RAN 90.06

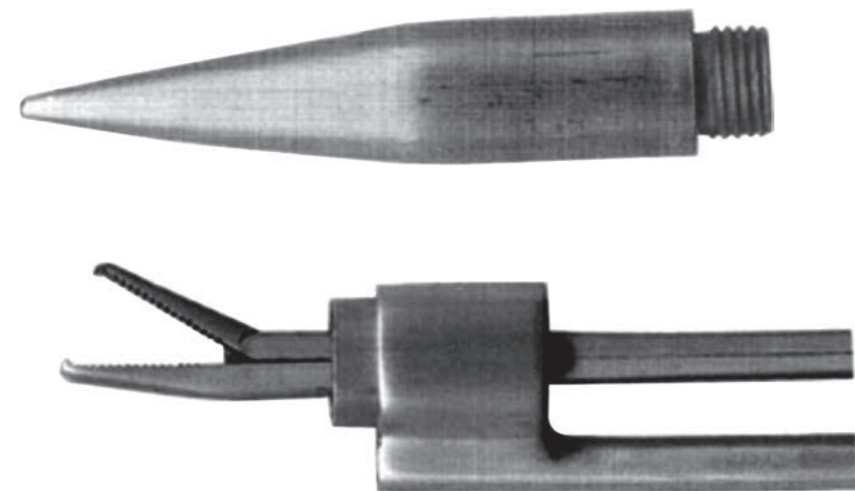

ANAL RETRACTOR

22mm x 92mm



ADULT
RAN 90.02

17mm x 65mm



CHILD
RAN 90.01



PARK ANAL RETRACTOR
RAN 90.01-RAN 90.02

70mm



PARK ANAL RECTAL RETRACTOR
Complete Set
Centre Blade - 95mm
Lateral Blade - 70mm (1 pair)
Lateral Blade - 93mm (1 pair)
Total Length 140mm/5 1/2"
Opening 70mm

RAN 90.03

PELVIS RETRACTOR

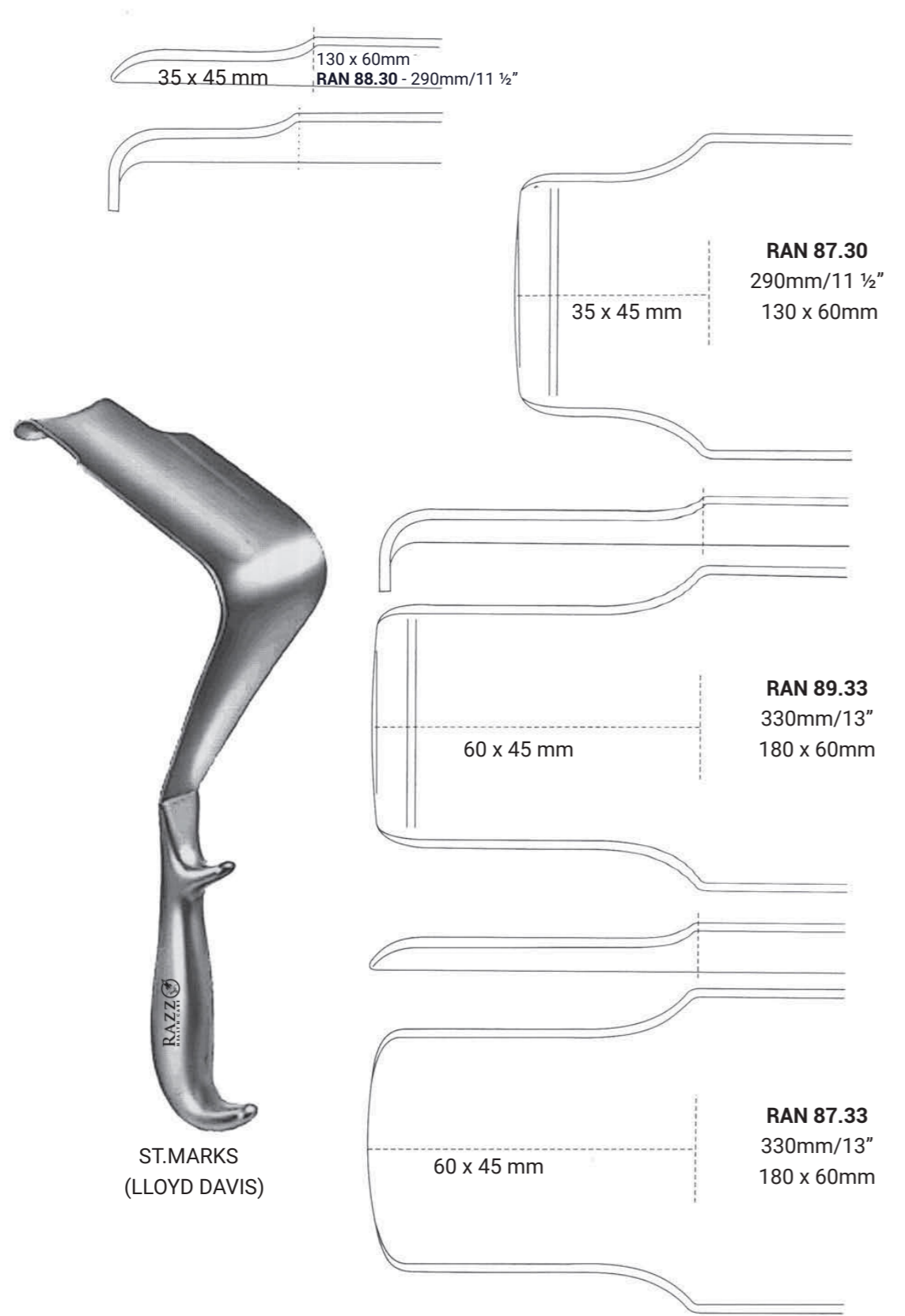

ST.MARKS (LLOYD DAVIS)

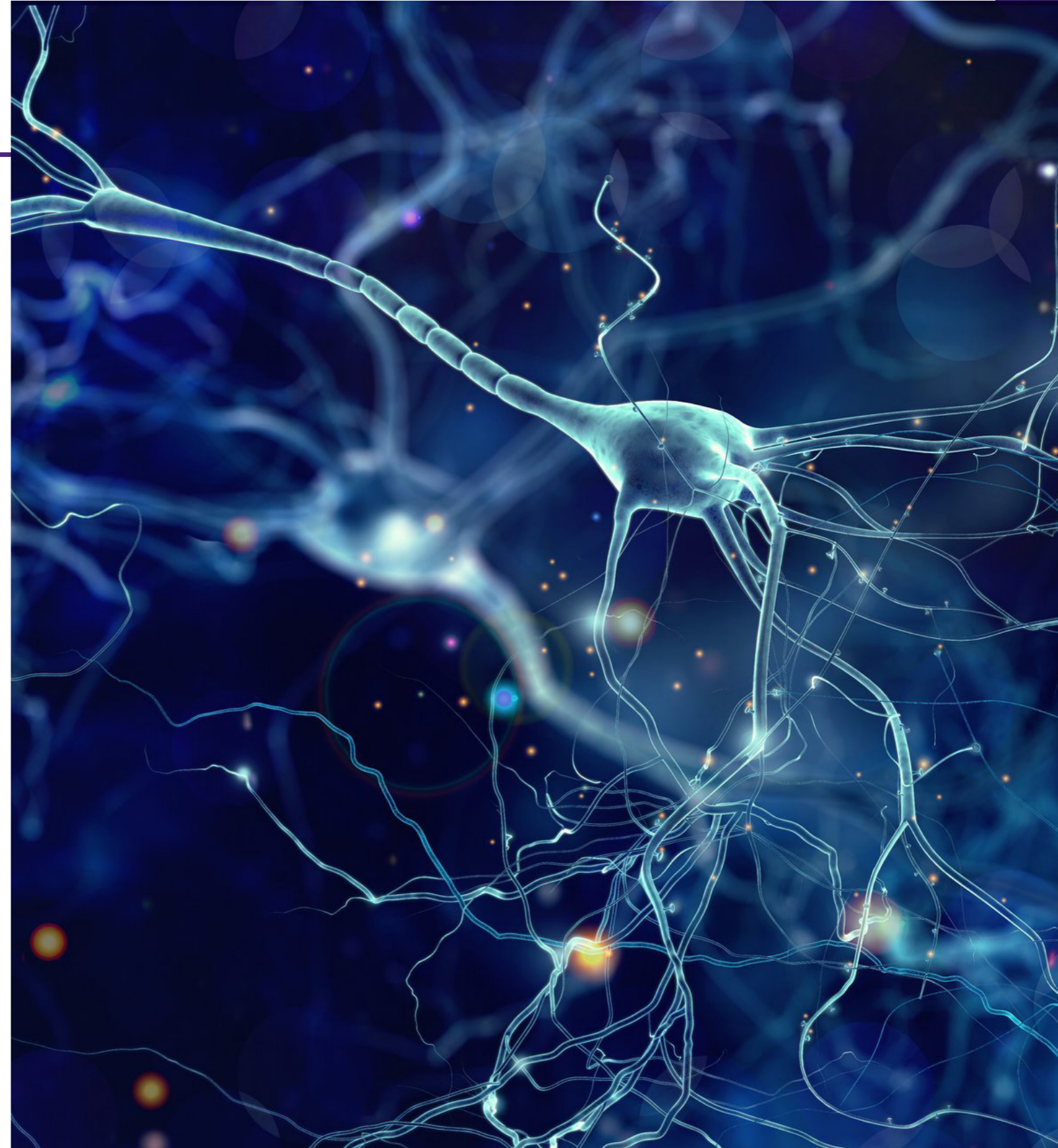

NEUROSURGERY

LAMINECTOMY PUNCHES

INTERVERTEBRAL DISC RONGEURS

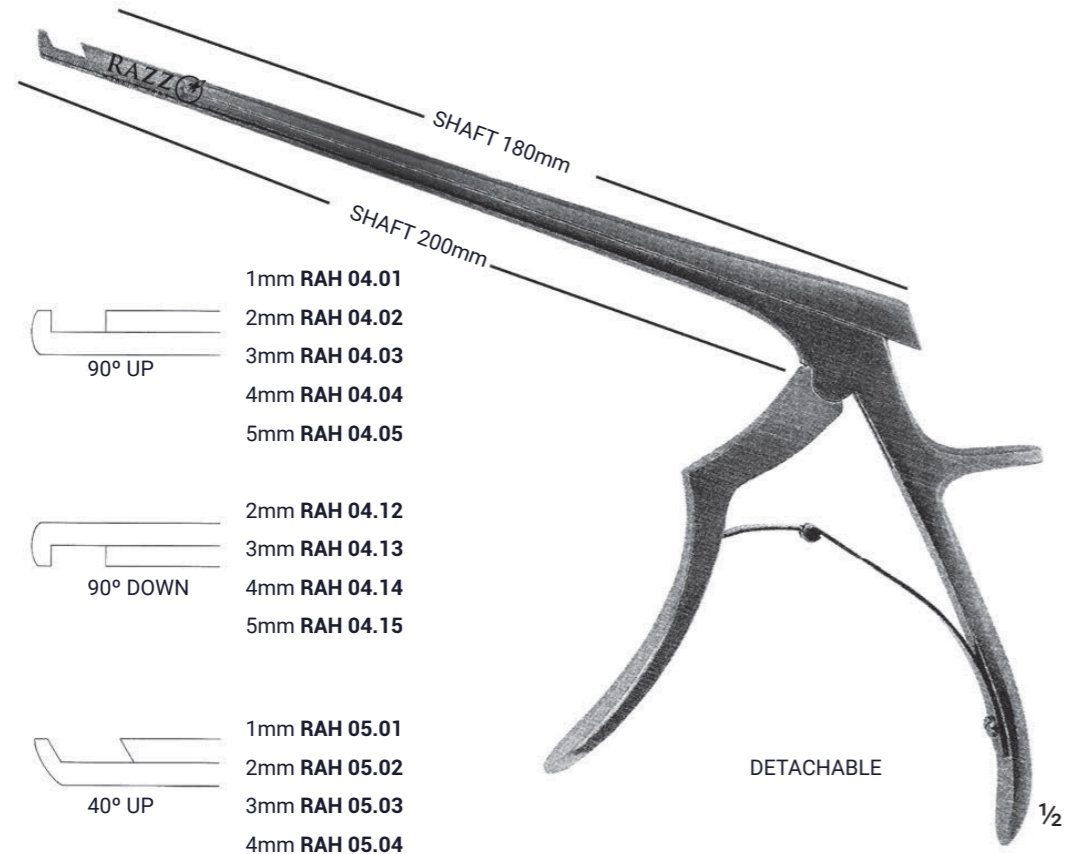

- 1mm RAH 04.01
 - 2mm RAH 04.02
 - 3mm RAH 04.03
 - 4mm RAH 04.04
 - 5mm RAH 04.05
- 90° UP
- 2mm RAH 04.12
 - 3mm RAH 04.13
 - 4mm RAH 04.14
 - 5mm RAH 04.15
- 90° DOWN
- 1mm RAH 05.01
 - 2mm RAH 05.02
 - 3mm RAH 05.03
 - 4mm RAH 05.04
 - 5mm RAH 05.05
- 40° UP
- 2mm RAH 05.12
 - 3mm RAH 05.13
 - 4mm RAH 05.14
 - 5mm RAH 05.15
- 40° DOWN

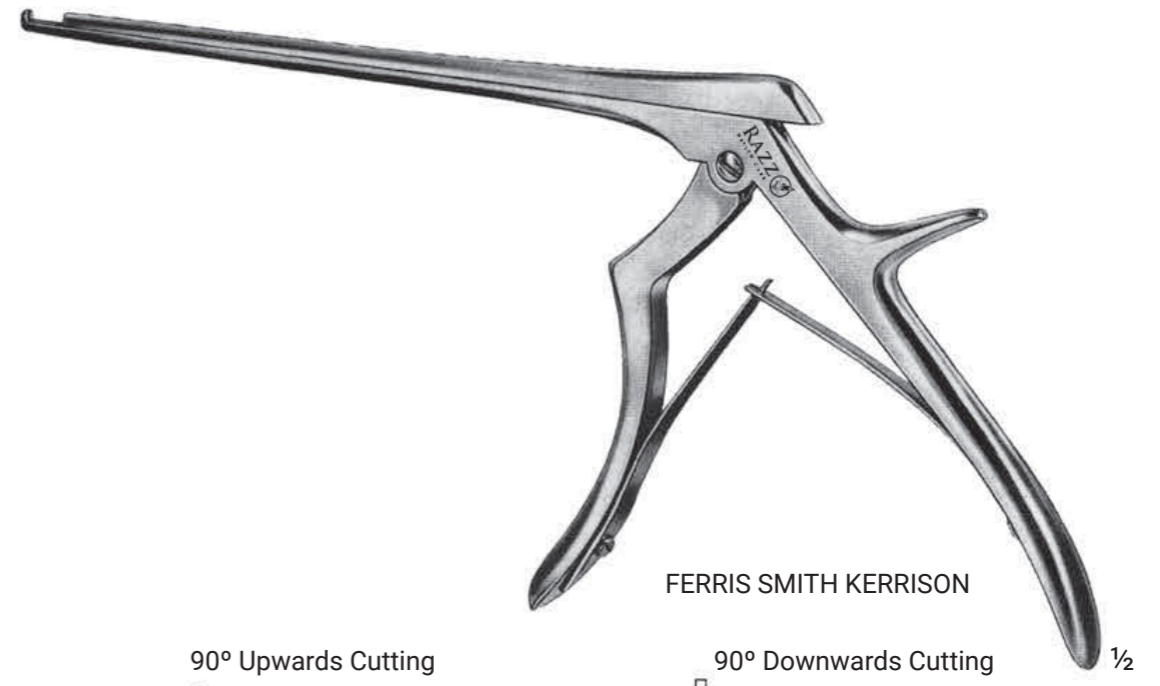

- 90° Upwards Cutting
- RAH 03.01
1mm
 - RAH 03.02
2mm
 - RAH 03.03
3mm
 - RAH 03.04
4mm
 - RAH 03.05
5mm
 - RAH 03.06
6mm

- 90° Downwards Cutting
- RAH 03.11
1mm
 - RAH 03.12
2mm
 - RAH 03.13
3mm
 - RAH 03.14
4mm
 - RAH 03.15
5mm
 - RAH 03.16
6mm

INTERVERTEBRAL DISC RONGEURS

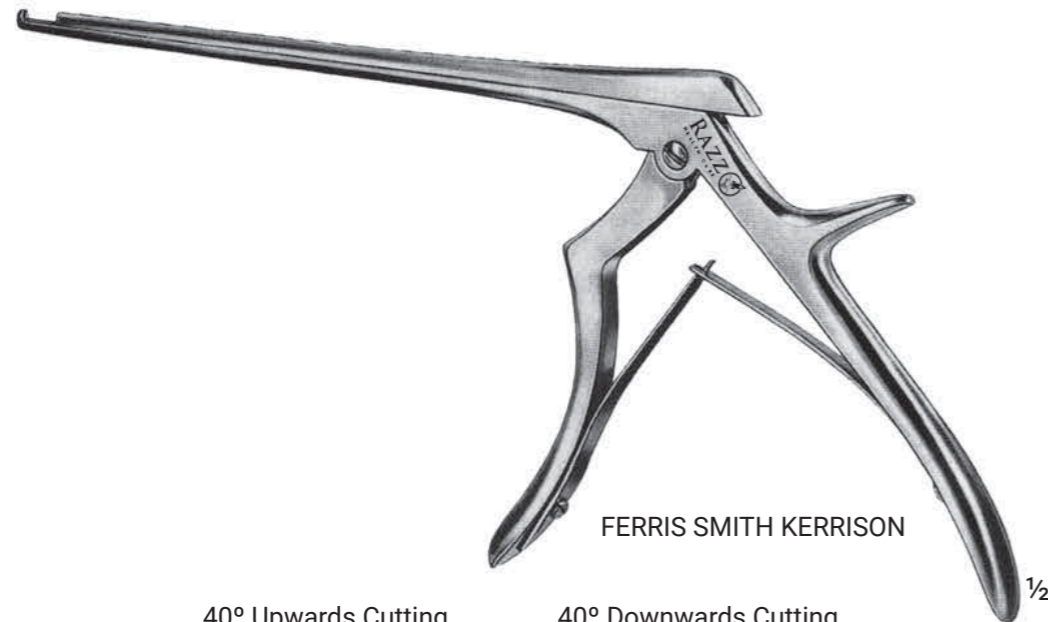

40° Upwards Cutting



RAH 03.21
1mm



RAH 03.22
2 mm



RAH 03.23
3 mm

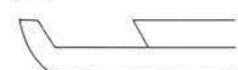

RAH 03.24
4 mm



RAH 03.25
5 mm



RAH 03.26
6 mm

40° Downwards Cutting



RAH 03.31
1mm



RAH 03.32
2 mm



RAH 03.33
3 mm



RAH 03.34
4 mm

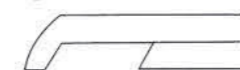

RAH 03.35
5 mm



RAH 03.36
6 mm

1/1

INTERVERTEBRAL DISC RONGEURS

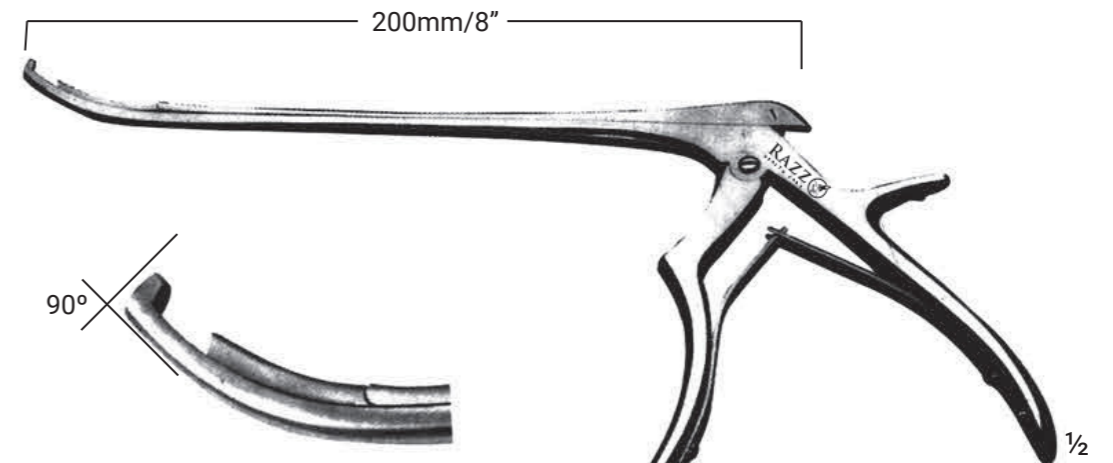

RAH 03.17
2mm

RAH 03.18
3 mm

RAH 03.19
4 mm

RAH 03.20
5mm

KERRISON PUNCH
Shaft Curved Upward
200mm/8"

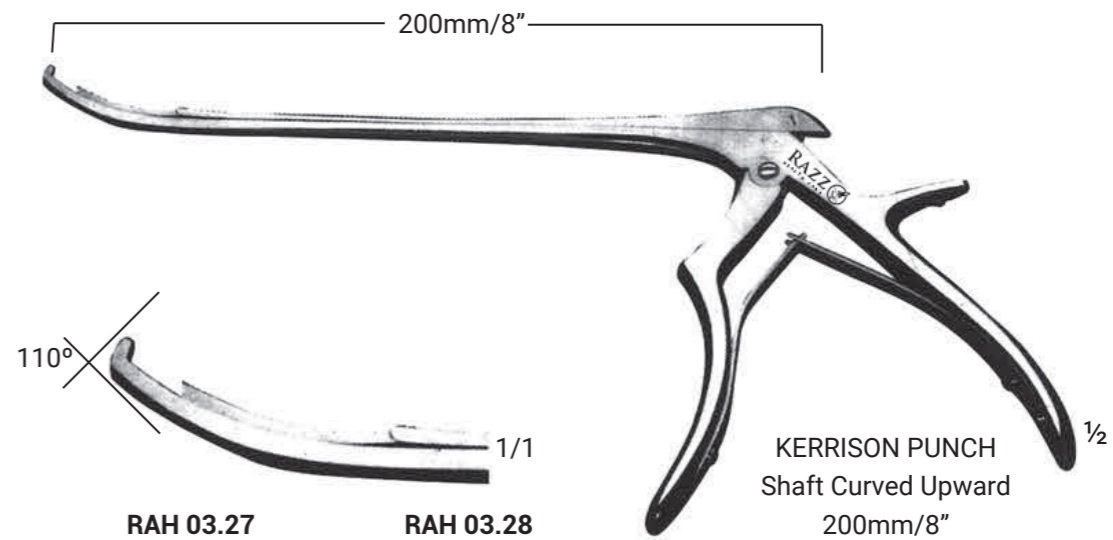

RAH 03.27
2mm

RAH 03.28
3 mm

RAH 03.29
4 mm



RAH 03.30
5mm

KERRISON PUNCH
Shaft Curved Upward
200mm/8"

ANTRUM PUNCH FORCEPS

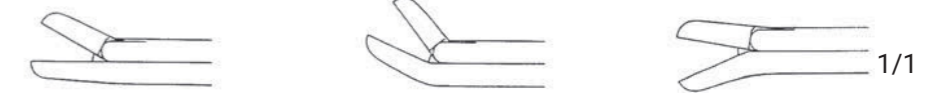
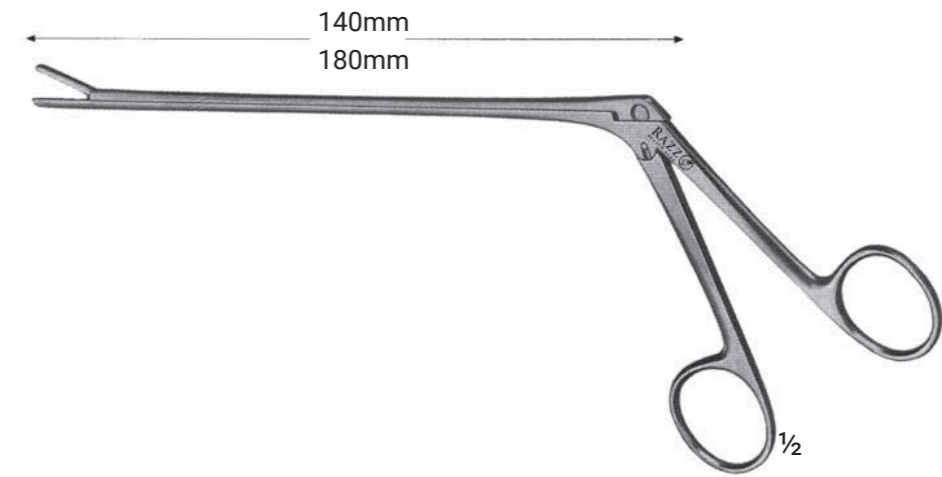
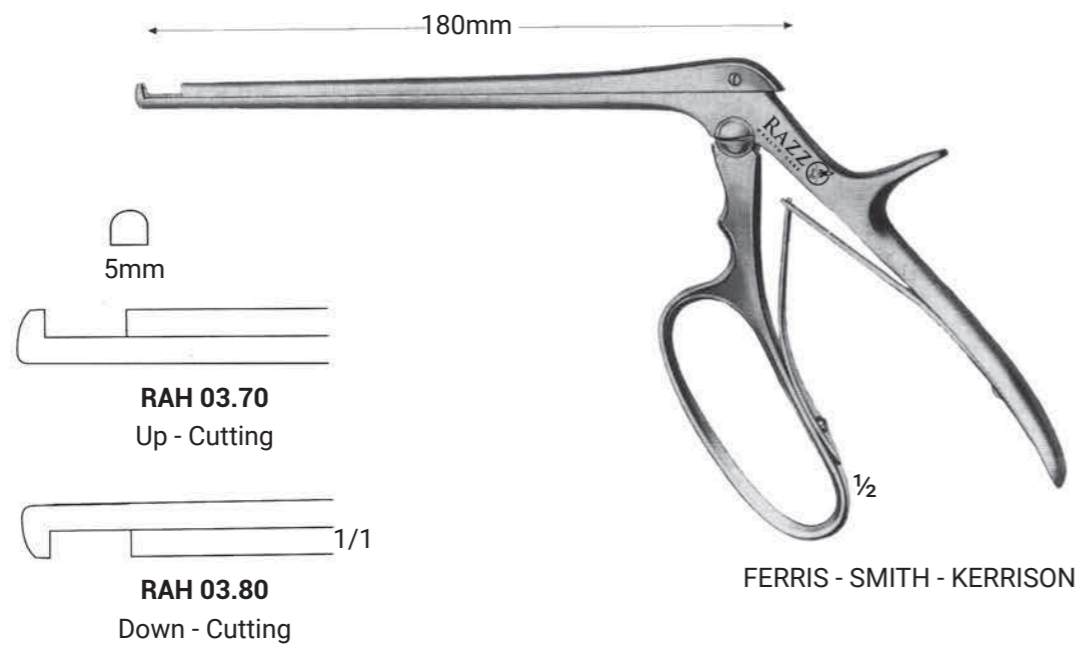
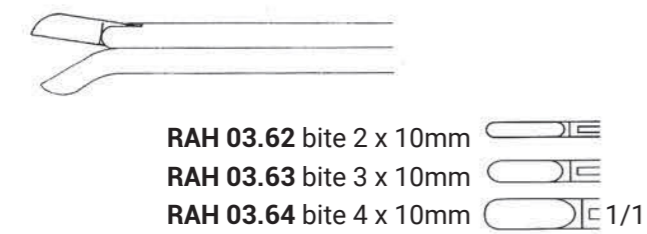
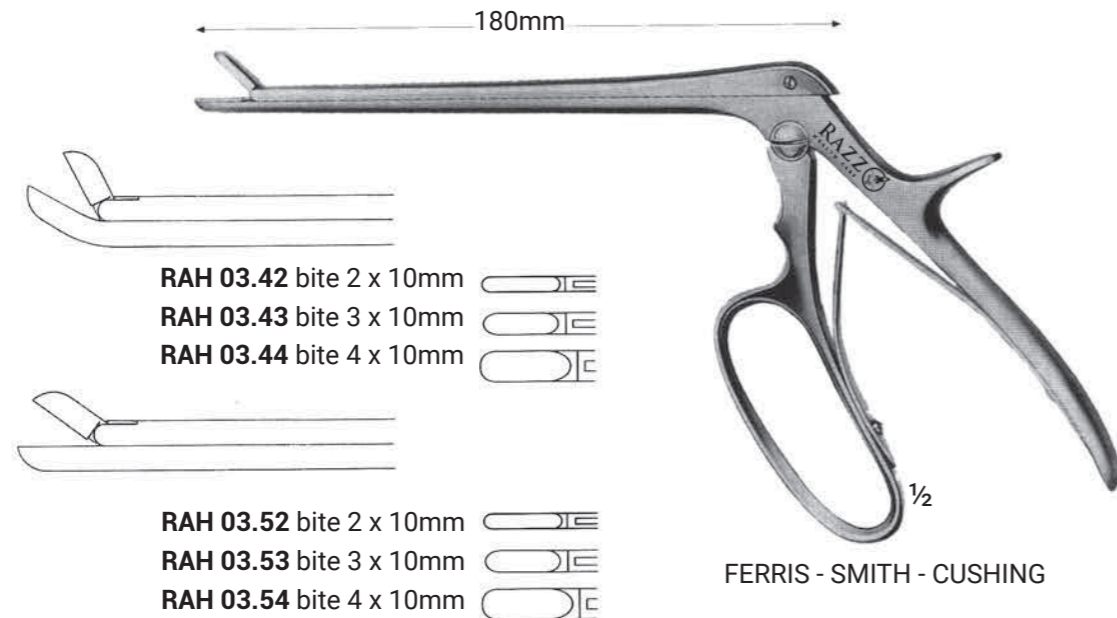
LAMINECTOMY RONGEURS



	Shaft Size	Straight	Upward	Downwards
 CUSHING 2 x 10 mm	130mm/5 1/2"	RAH 04.22	RAH 04.32	RAH 04.42
	180mm/7"	RAH 04.51	RAH 04.52	RAH 04.53
 LOVE GRUENWALD 3 x 10 mm	130mm/5 1/2"	RAH 08.02	RAH 08.03	RAH 08.04
	180mm/7"	RAH 08.22	RAH 08.23	RAH 08.24
 SPURLING 4 x 10 mm	130mm/5 1/2"	RAH 09.02	RAH 09.03	RAH 09.04
	180mm/7"	RAH 09.33	RAH 09.34	RAH 09.35

LAMINECTOMY RONGEURS

LAMINECTOMY RONGEURS

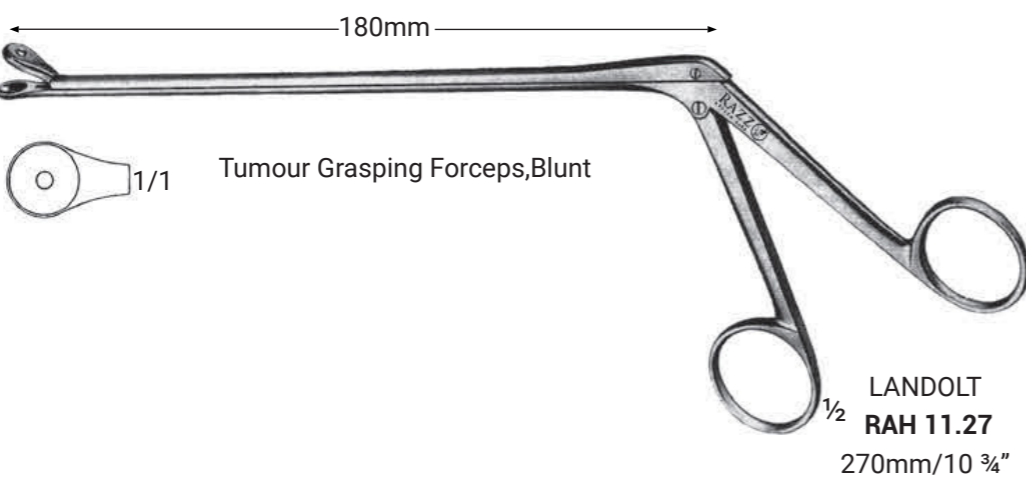
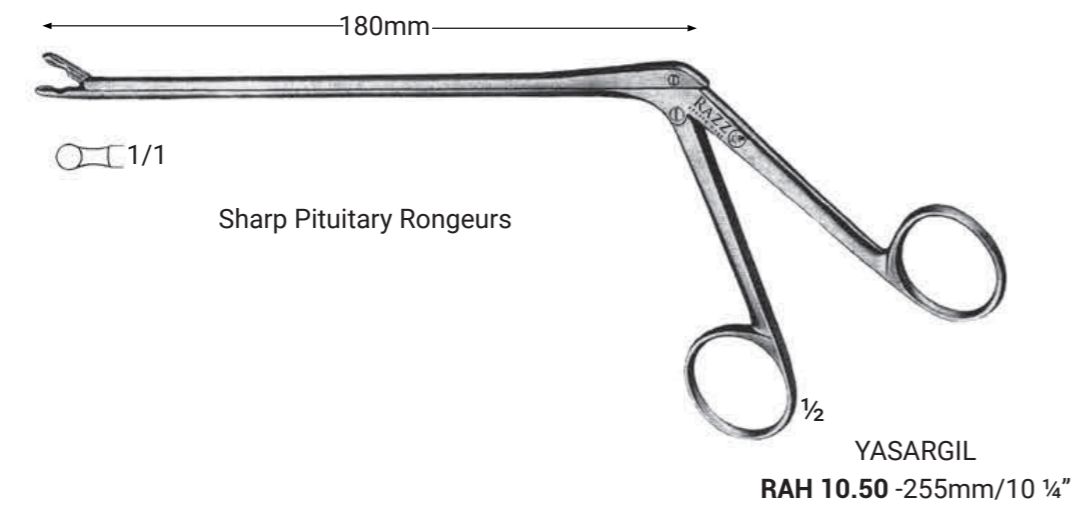
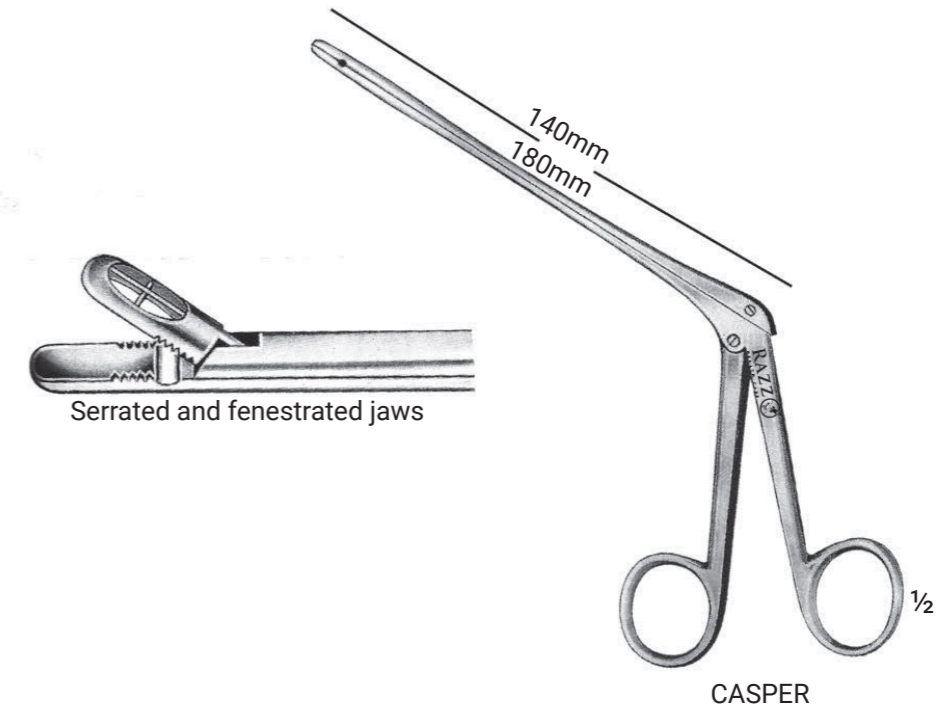
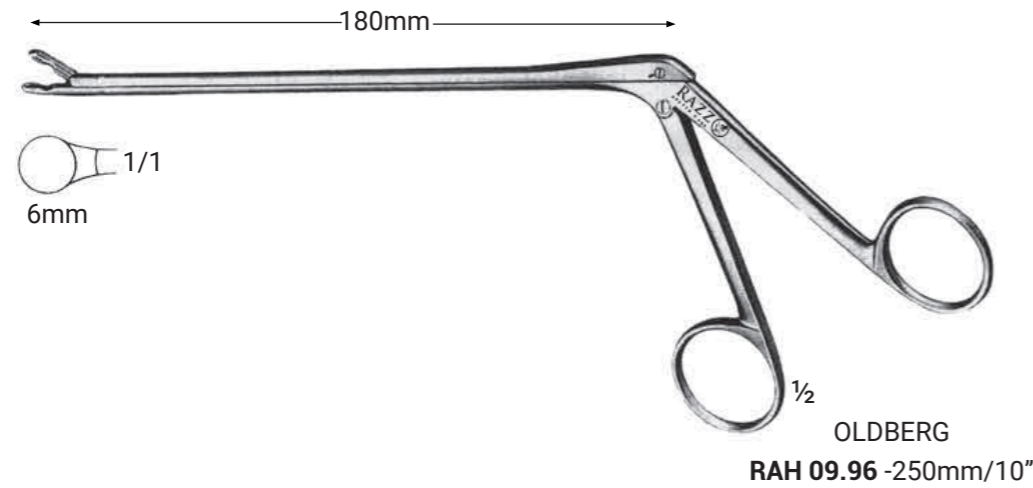

width of Jaw	Length of shaft		
	140mm / 5 1/2"	180mm / 7"	210mm / 8 1/4"
2 x 10mm	RAH 04.16	RAH 08.15	RAH 12.15
	RAH 04.45	RAH 08.45	RAH 12.45
3 x 10mm	RAH 09.15	RAH 09.45	RAH 10.75
	RAH 11.15	RAH 11.45	RAH 11.75
4 x 10mm	RAH 13.15	RAH 13.45	RAH 13.75
	RAH 14.15	RAH 14.45	RAH 14.75
5 x 10mm	RAH 15.15	RAH 15.45	RAH 15.75
	RAH 16.15	RAH 16.45	RAH 16.75
6 x 10mm	RAH 17.15	RAH 17.45	RAH 17.75
	RAH 18.15	RAH 18.45	RAH 18.75

DELICATE PATTERN FORCEPS & SPLINTER FORCEPS

CILIA FORCEPS & SPLINTER FORCEPS



JEWELLER STYLE

RAE 79.03	RAE 81.05	RAE 82.07
No.3	No.5	No.7
115mm/4 1/2"	115mm/4 1/2"	115mm/4 1/2"

A	B		C	D
RAE 90.09	RAE 90.19	90mm/3 1/2"	RAE 91.09	RAE 91.19
RAE 90.11	RAE 90.21	110mm/4 1/2"	RAE 91.11	RAE 91.21
RAE 90.12	RAE 90.22	125mm/5"	RAE 91.12	RAE 91.22

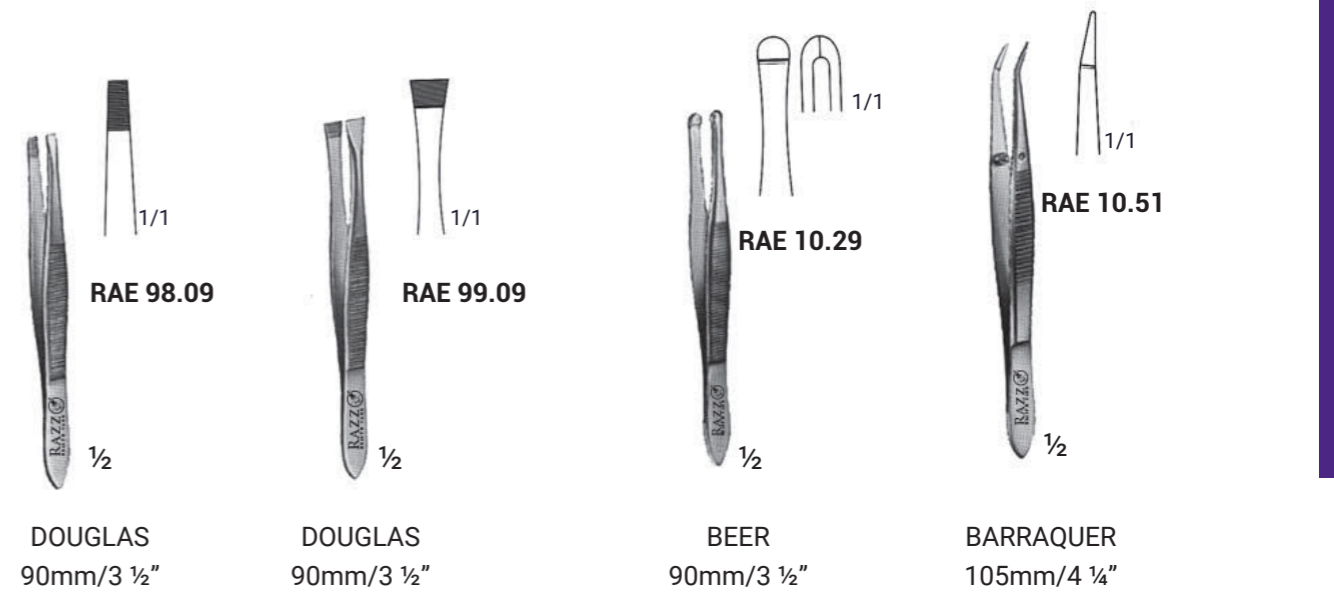

DOUGLAS 90mm/3 1/2" RAE 98.09
 DOUGLAS 90mm/3 1/2" RAE 99.09
 BEER 90mm/3 1/2" RAE 10.29
 BARRAQUER 105mm/4 1/4" RAE 10.51

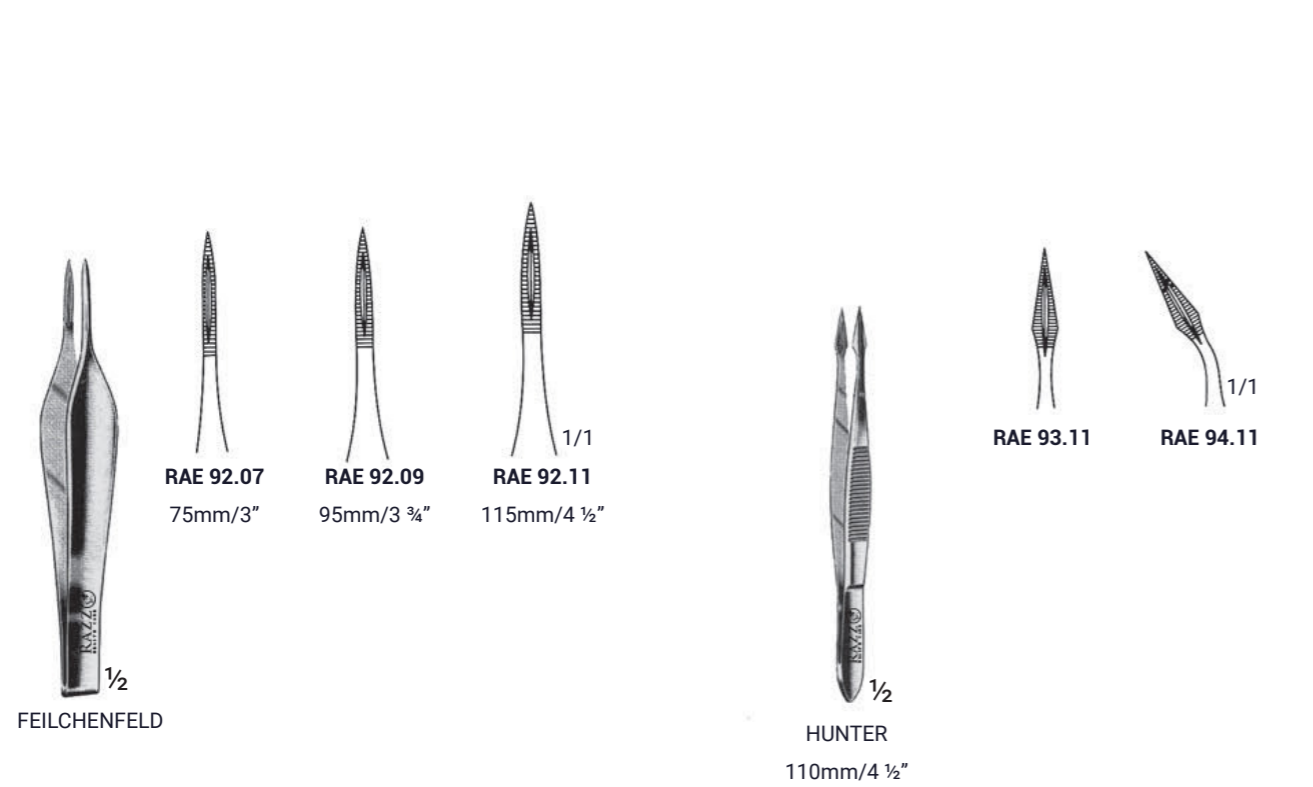

FEILCHENFELD 1/2"
 HUNTER 110mm/4 1/2"
 RAE 92.07 75mm/3"
 RAE 92.09 95mm/3 3/4"
 RAE 92.11 115mm/4 1/2"
 RAE 93.11
 RAE 94.11 1/1"

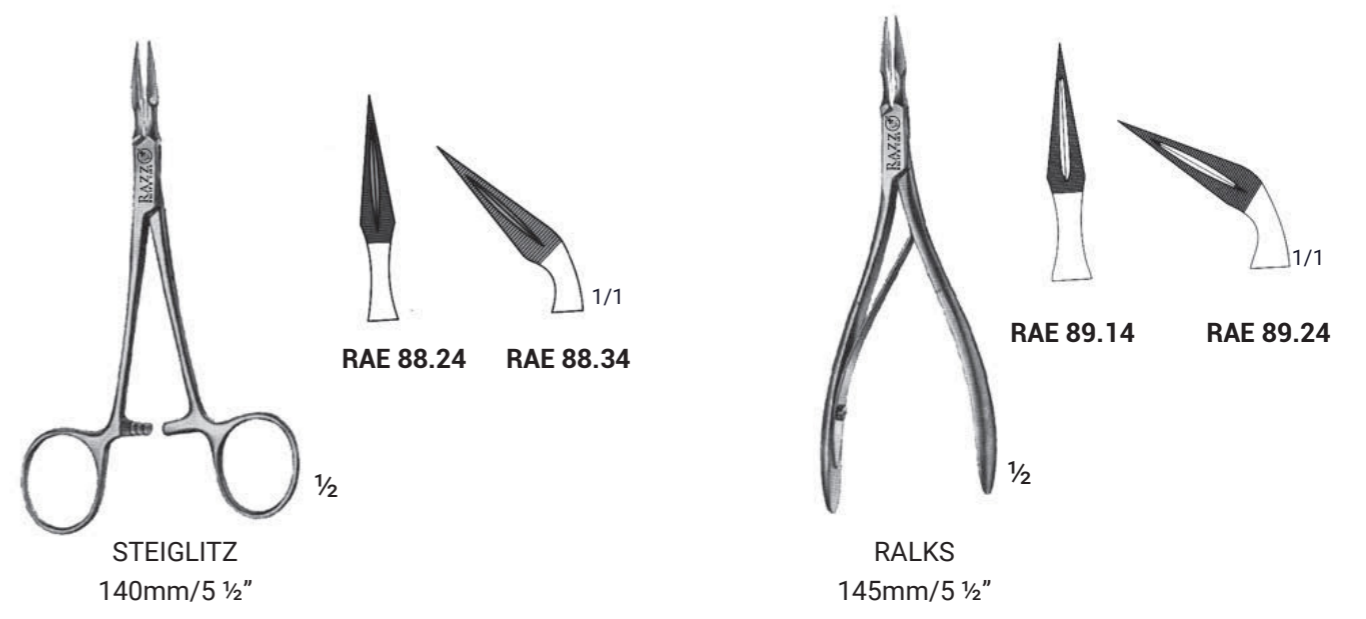

STEIGLITZ 140mm/5 1/2" 1/2"
 RAE 88.24 RAE 88.34 1/1
 RALKS 145mm/5 1/2" 1/2"
 RAE 89.14 RAE 89.24 1/1"

MICRO EYE FORCEPS & CHALAZION FORCEPS

CLIP APPLYING, REMOVING FORCEPS & LIGATURE SCISSORS

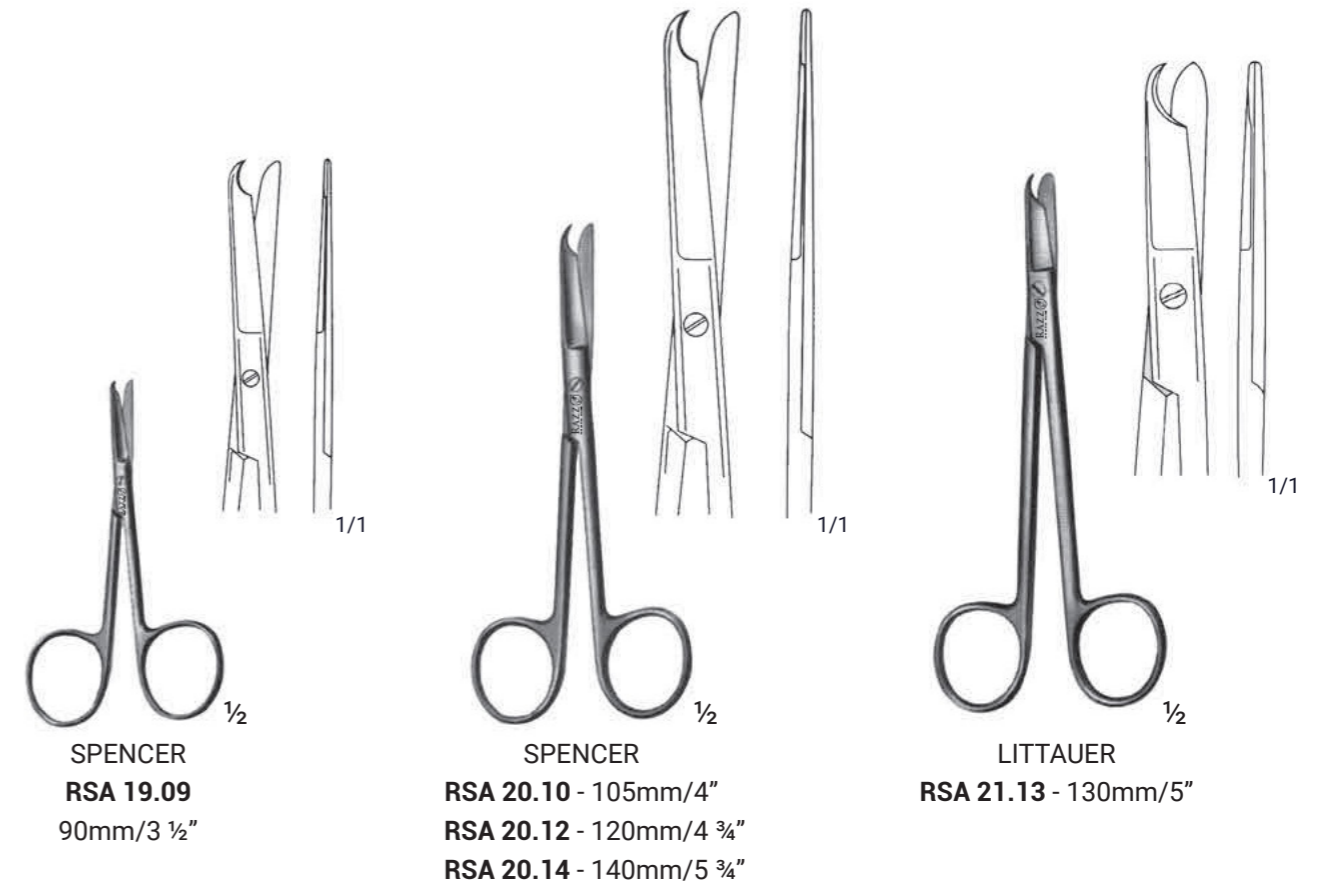
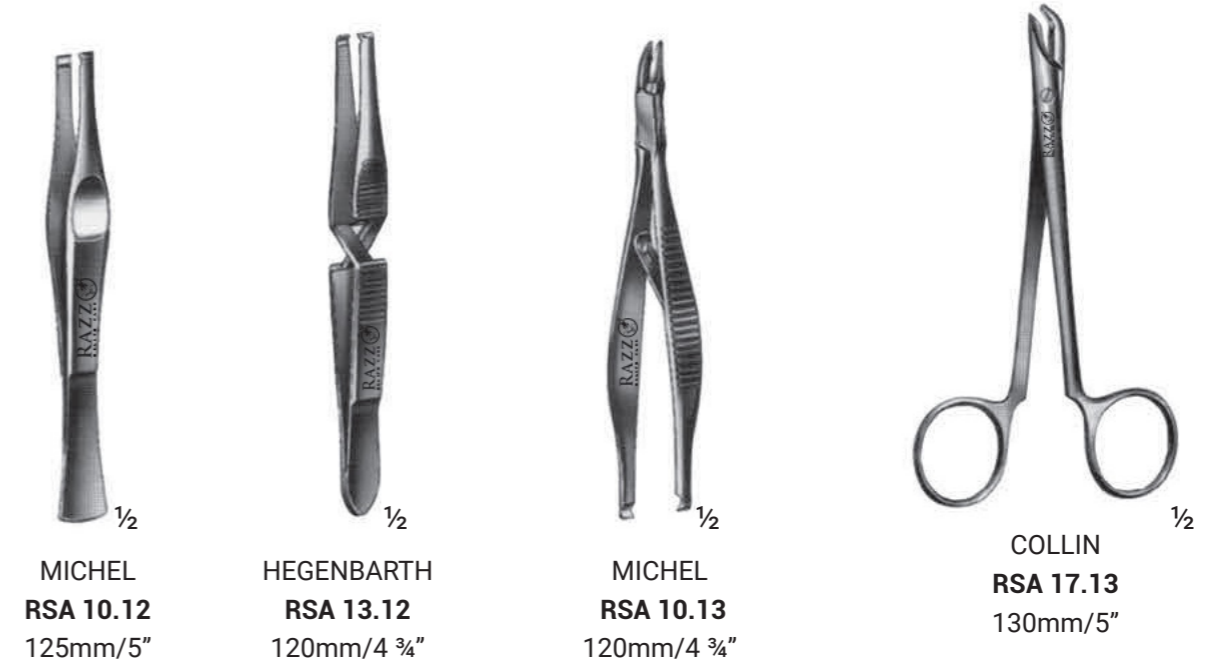
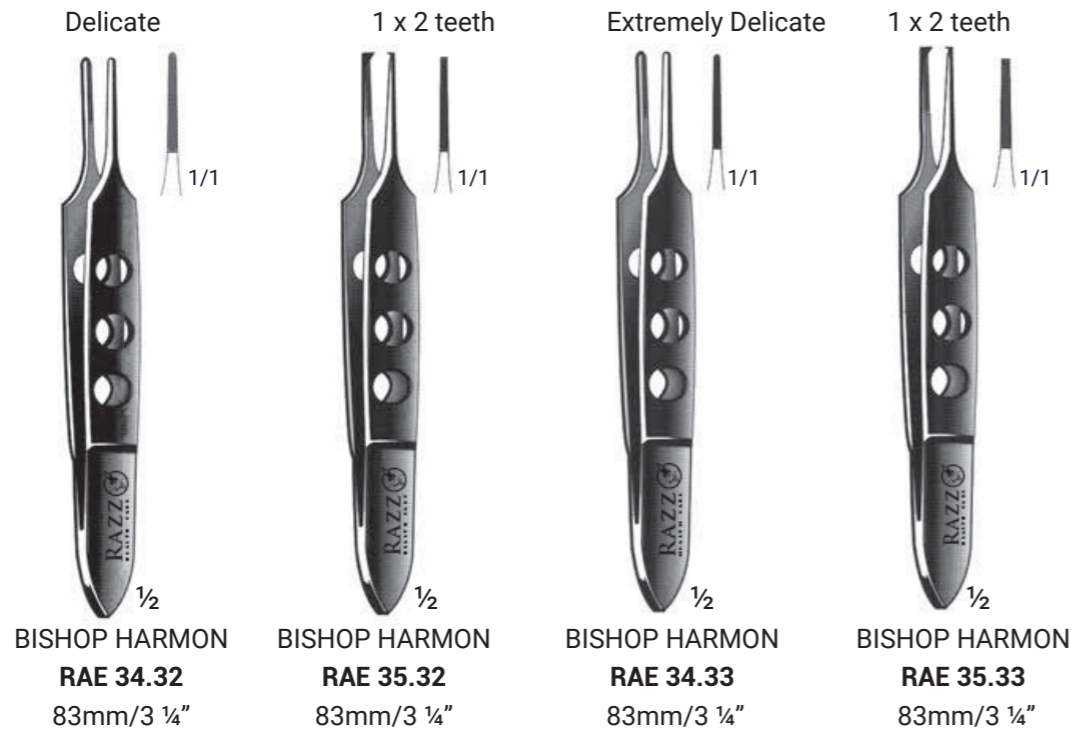

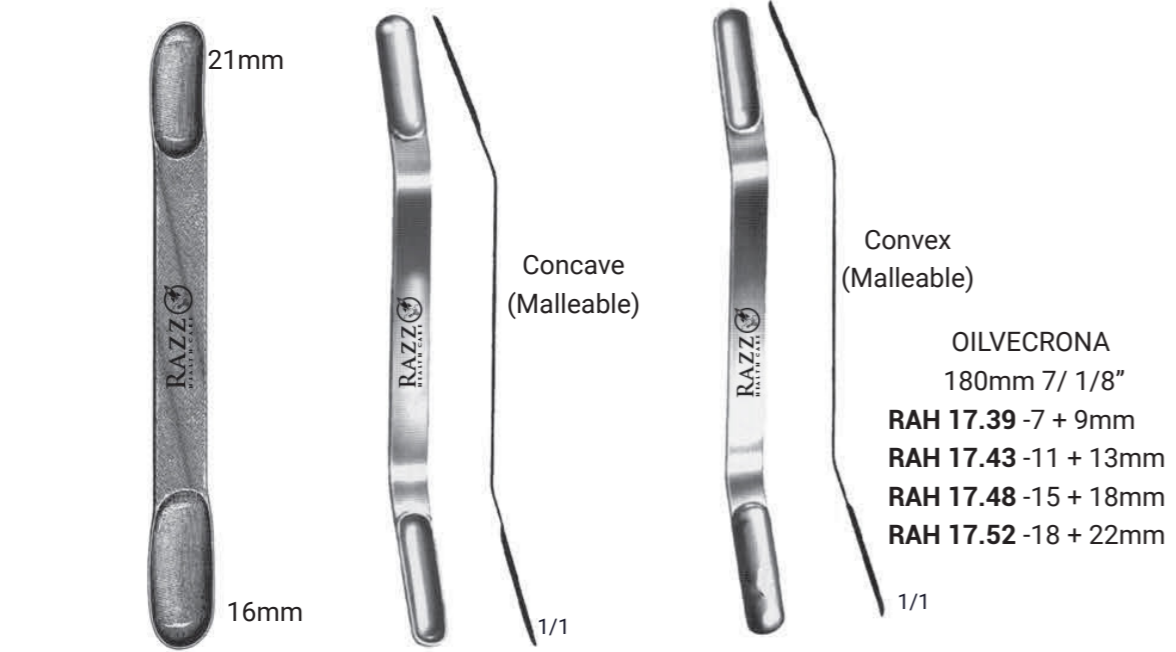

CUSHING
 RAH 15.17 -170mm/6 3/4"
 RAH 15.18 -200mm/8"

OILVECRONA
 180mm 7/ 1/8"
 RAH 16.09 - 7 + 9mm
 RAH 16.11 - 11 + 13mm
 RAH 16.13 - 15 + 18mm
 RAH 16.14 - 18 + 22mm



FRAZIER
 RAH 18.01
 150mm/6"

HOEN
 RAH 18.02
 150mm/6"

HOEN
 RAH 18.03
 150mm/6"



DAVIS
 RAH 41.24
 245mm/9 3/4"



PENFIELD
 RAH 37.51
 175mm/7"
 Fig 1









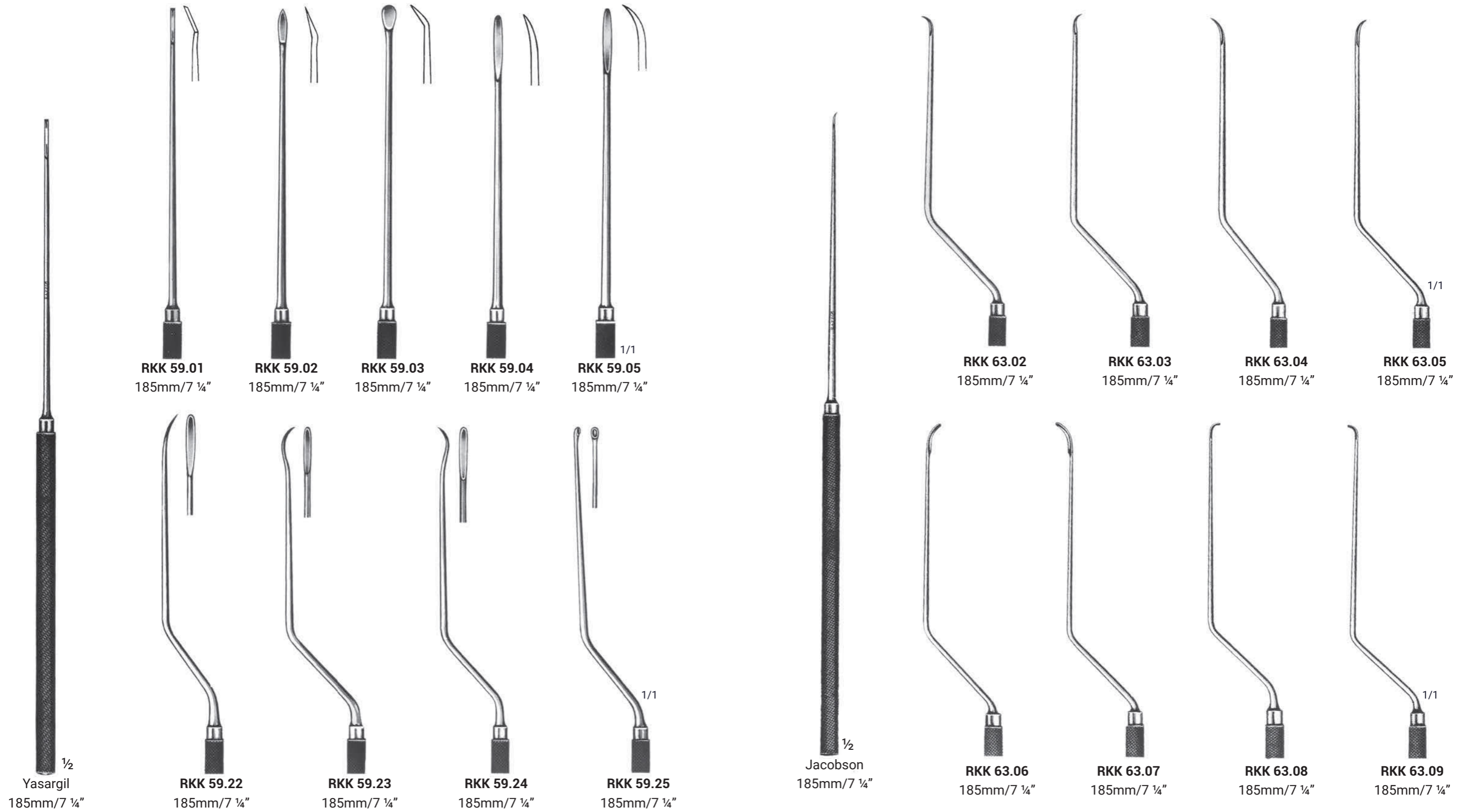

















PENFIELD
 RAH 37.52
 195mm/7 3/4"
 Fig 2

PENFIELD
 RAH 37.53
 195mm/7 3/4"
 Fig 3

PENFIELD
 RAH 37.54
 215mm/8 1/2"
 Fig 4

PENFIELD
 RAH 37.55
 290mm/11 1/2"
 Fig 5



 <p>Rhoton 190mm/7 1/2"</p>	<p>Ø 1mm</p>  <p>RKK 63.12 Dissector, Round</p>	<p>Ø 2mm</p>  <p>RKK 63.13 Dissector, Round</p>	<p>Ø 3mm</p>  <p>RKK 63.14 Dissector, Round</p>	<p>Ø 1mm</p>  <p>RKK 63.15 Dissector, Round</p>	 <p>Okonex 230mm/9"</p>	<p>RKK 60.03</p> 	<p>RKK 60.04</p> 	 <p>Okonex 190mm/7 1/2"</p>	<p>RKK 65.01</p> 
	<p>Ø 1,5mm</p>  <p>RKK 63.16 spatula shaped</p>	<p>Ø 2,0mm</p>  <p>RKK 63.17 spatula shaped</p>	<p>Ø 1,2mm</p>  <p>RKK 63.18 Elevator</p>	<p>Ø 2,8mm</p>  <p>RKK 63.19 Elevator</p>		<p>RKK 60.05</p> 	<p>RKK 60.08 1/1</p> 		<p>RKK 65.02</p> 
	<p>RKK 63.20 Needle, semi -sharp</p> 	<p>90° 2mm</p> <p>RKK 63.21 Hook, Blunt</p> 	<p>90° 2mm</p> <p>RKK 63.22 Hook, semi - sharp</p> 	<p>45° 3mm</p> <p>RKK 63.23 Hook, semi - sharp</p> 		 <p>Okonex 190mm/7 1/2"</p>	<p>RKK 65.03</p> 		
	<p>90°</p> <p>RKK 63.24 Probe, angled Ball Tipped</p> 	<p>1,0 x 2,0mm</p> <p>RKK 63.25 Curette, oval</p> 	<p>45°1,0 x 2,0mm</p> <p>RKK 63.26 Curette, oval,Angled</p>  <p>1/1</p>	<p>RKK 65.04 1/1</p> 					

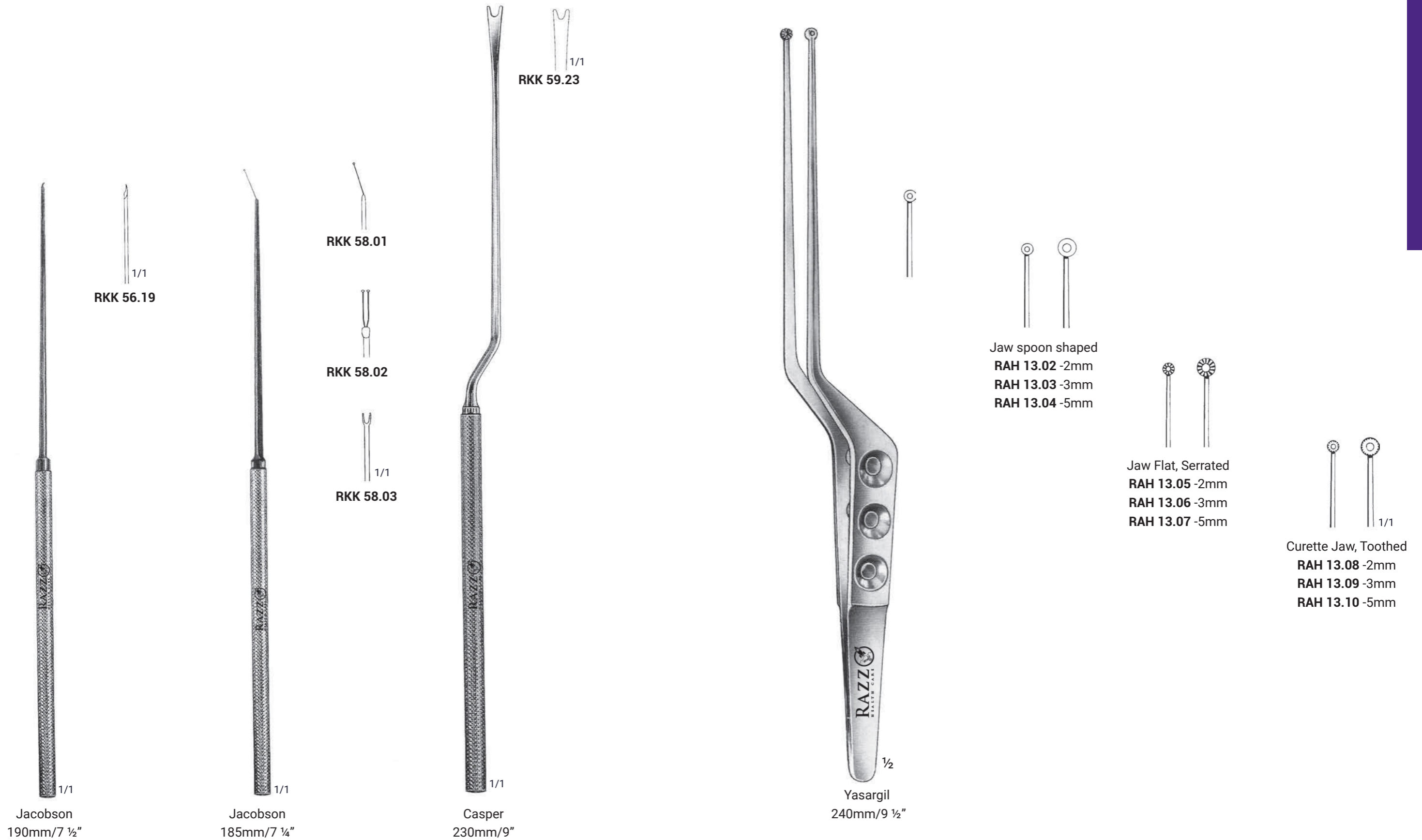

1/1
RKK 56.19

1/1
Jacobson
190mm/7 1/2"

RKK 58.01

RKK 58.02

1/1
RKK 58.03

1/1
Jacobson
185mm/7 1/4"

1/1
RKK 59.23

1/1
Casper
230mm/9"

Jaw spoon shaped
RAH 13.02 -2mm
RAH 13.03 -3mm
RAH 13.04 -5mm

1/2
Yasargil
240mm/9 1/2"

Jaw Flat, Serrated
RAH 13.05 -2mm
RAH 13.06 -3mm
RAH 13.07 -5mm

1/1
Curette Jaw, Toothed
RAH 13.08 -2mm
RAH 13.09 -3mm
RAH 13.10 -5mm

YASARGIL FORCEPS

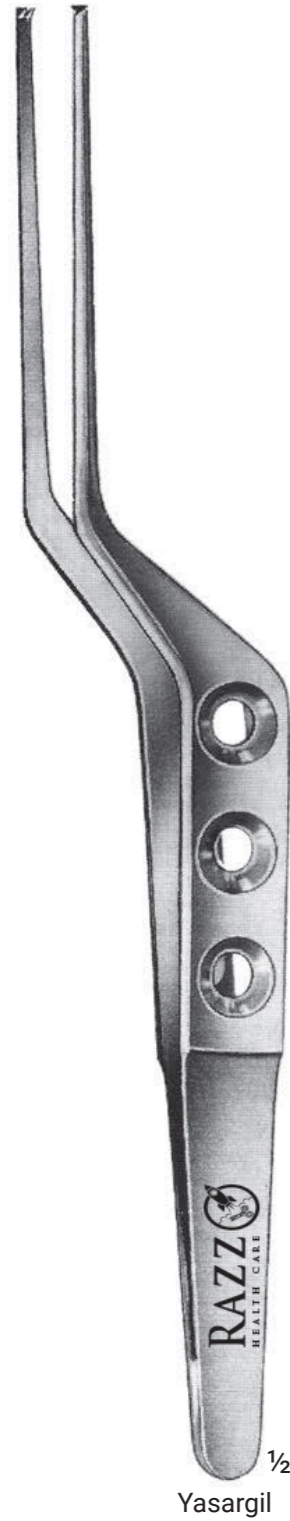

160mm/6 $\frac{1}{4}$ "
 180mm/7"
 200mm/8"
 220mm/8 $\frac{3}{4}$ "
 240mm/9 $\frac{1}{2}$ "



RAH 30.06
RAH 30.07
RAH 30.08
RAH 30.09
RAH 30.10



RAH 31.06
RAH 31.07
RAH 31.08
RAH 31.09
RAH 31.10



RAH 31.11
 180mm/7"

JEWELERS FORCEPS

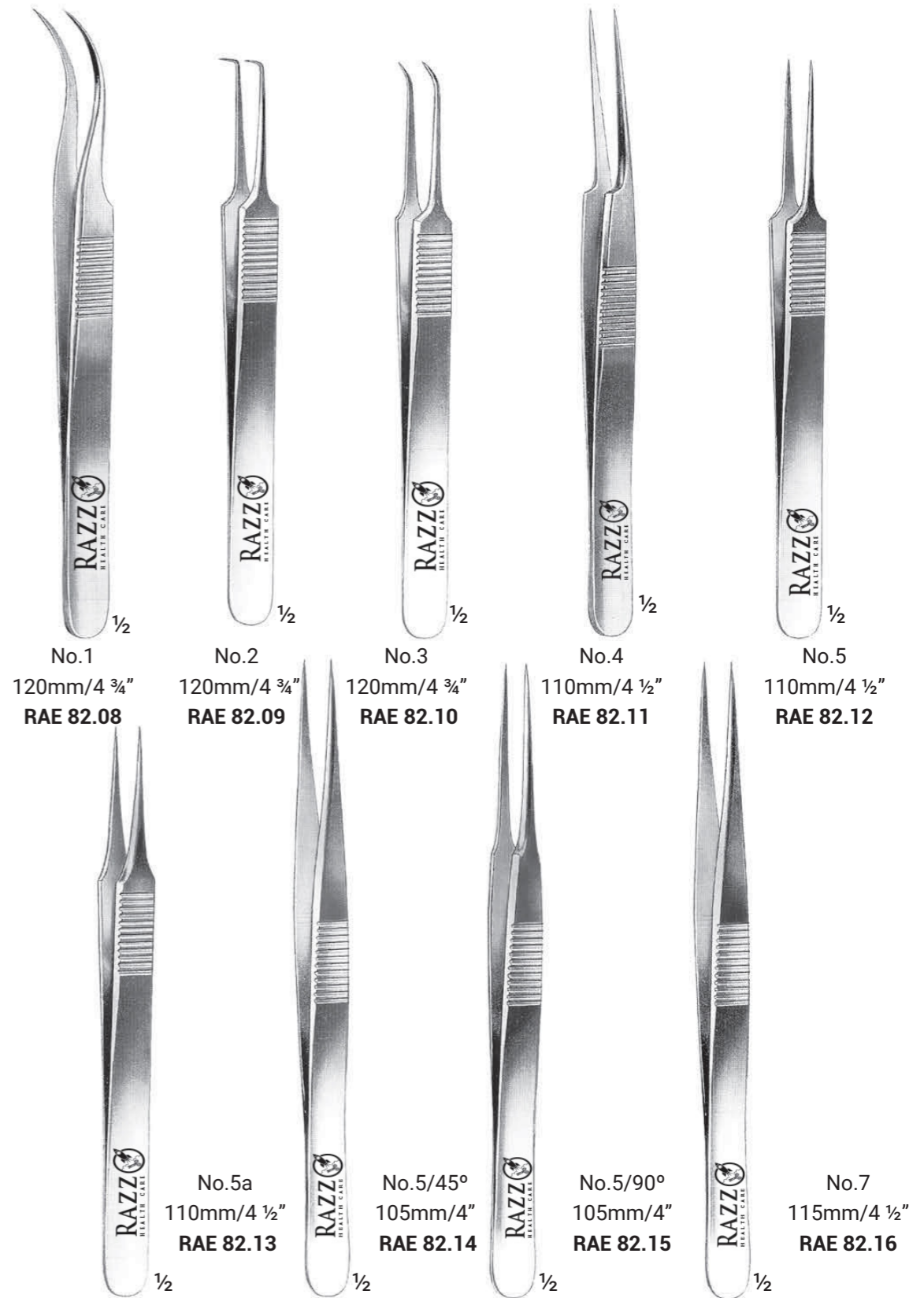

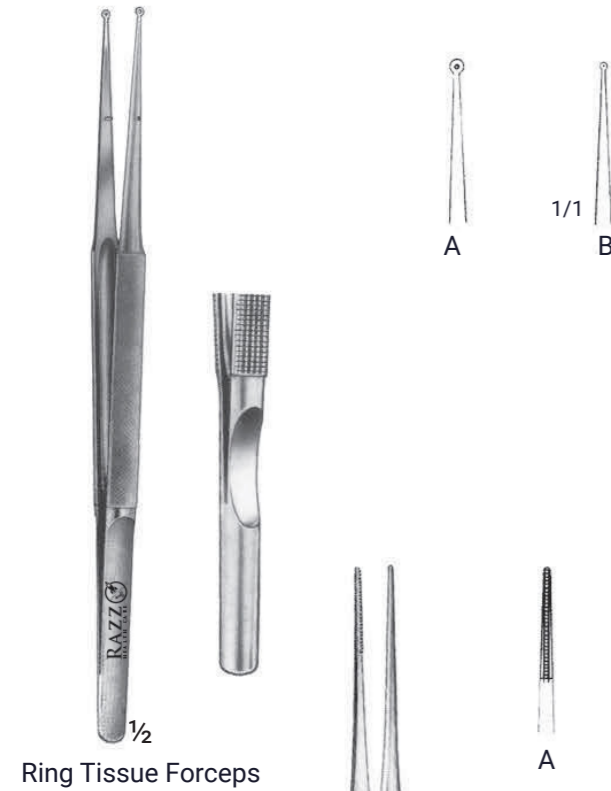

Ring Tissue Forceps

FIG	LENGTH (mm)	CAT NO.	RING Ø (mm)
A	150	RAH 01.51	1,5 x 2,0
A	180	RAH 01.80	1,5 x 2,0
A	210	RAH 02.10	1,5 x 2,0
B	150	RAH 02.51	0,5 x 1,0
B	180	RAH 02.80	0,5 x 1,0

FIG	LENGTH (mm)	CAT NO.	MAUL JAW
A	150	RAH 03.50	1,0
B	150	RAH 03.81	1,0
A	180	RAH 04.10	1,0
B	180	RAH 04.50	1,0
A	210	RAH 05.80	1,0

DeBakey
Micro Tissue Forceps

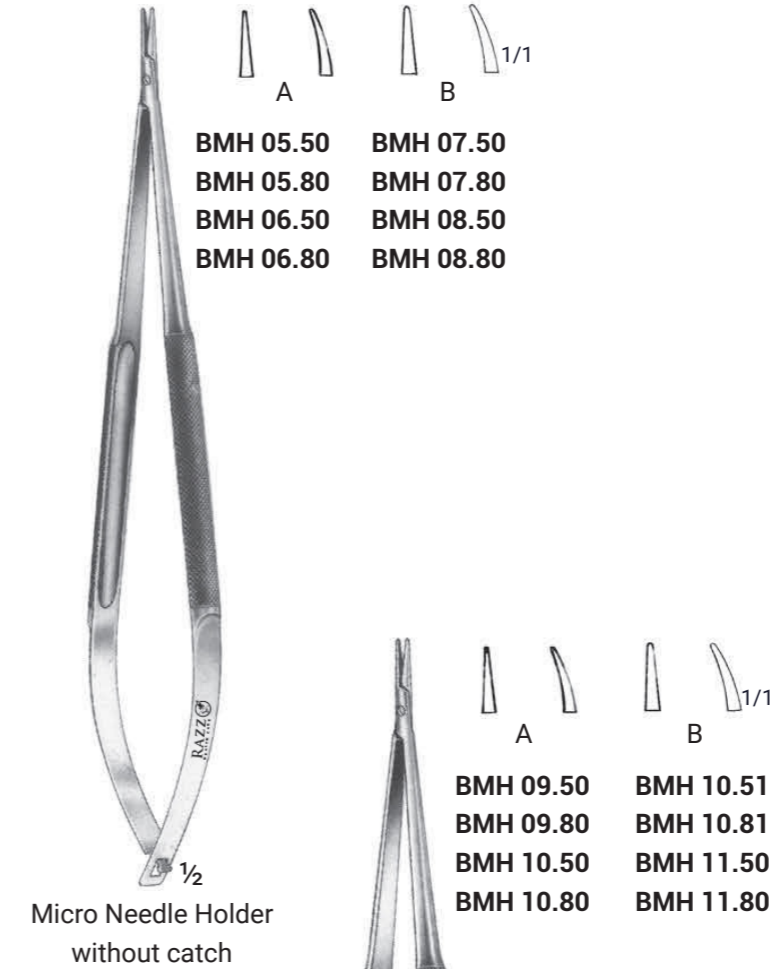

Micro Needle Holder
without catch

Micro Needle Holder
with catch

FIG	LENGTH (mm)
A	150mm/6"
B	150mm/6"
A	180mm/7"
B	180mm/7"
A	210mm/8 ¼"
B	210mm/8 ¼"
A	230mm/9"
B	230mm/9"

FIG	LENGTH (mm)
A	150mm/6"
B	150mm/6"
A	180mm/7"
B	180mm/7"
A	210mm/8 ¼"
B	210mm/8 ¼"
A	230mm/9"

YASARGIL MICRO SCISSORS

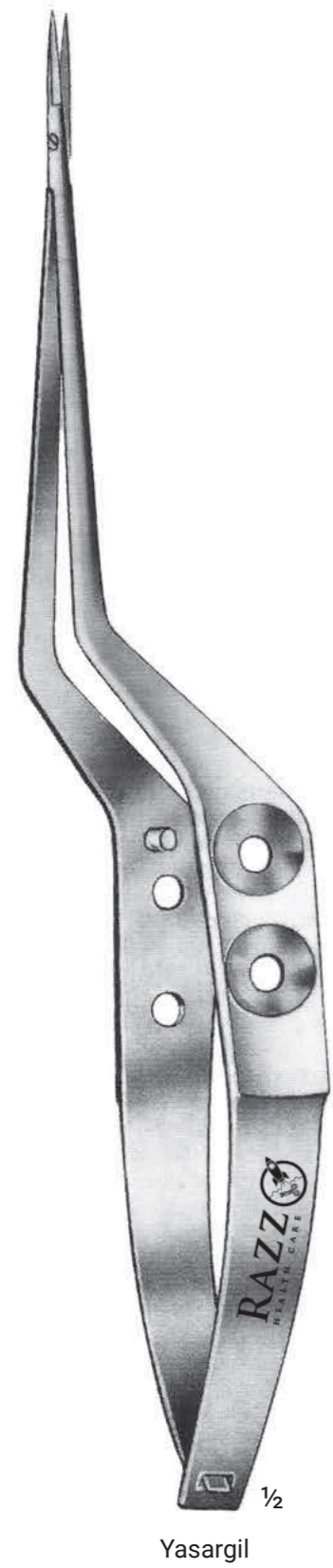

165mm/6 1/4"
200mm/8"



RSA 16.06
RSA 16.07
Straight



RSA 16.08
RSA 16.09
Curved



200mm/8" **RSA 16.10**
Curved Downwards



200mm/8" **RSA 16.11**
Straight



RSA 16.17
Curved

YASARGIL MICRO SCISSORS

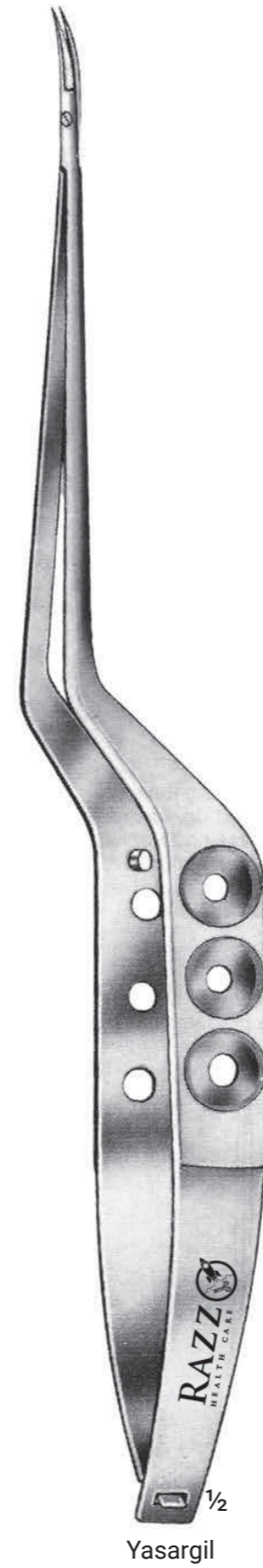

225mm/9"
245mm/9 3/4"



RSA 16.13
RSA 16.14
Straight



RSA 16.15
RSA 16.16
Curved



225mm/9" **RSA 16.17**
Curved Downwards



225mm/9" **RSA 16.18**
Straight



RSA 16.19
Curved

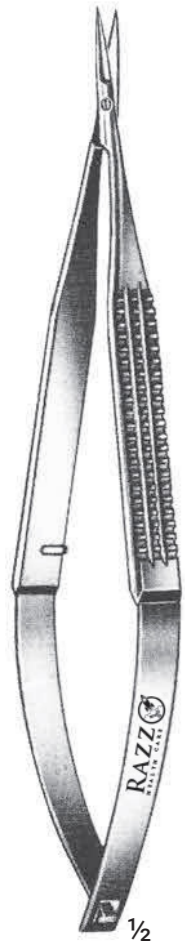

RSA 11.10
Straight
120mm/4 3/4"

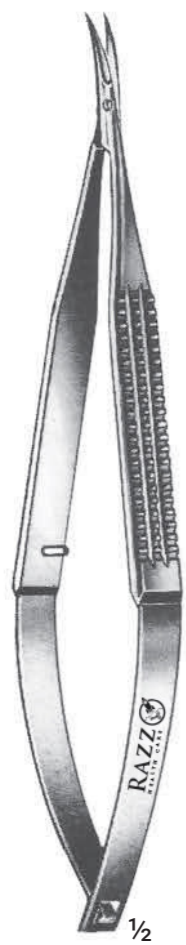

RSA 11.11
Curved
120mm/4 3/4"

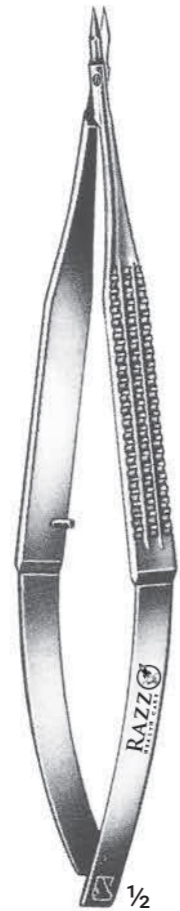

RSA 11.12
Straight
120mm/4 3/4"

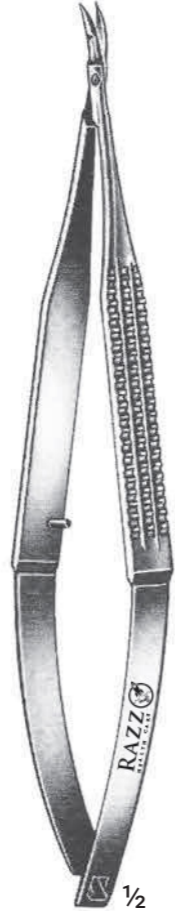

RSA 11.13
Curved
120mm/4 3/4"

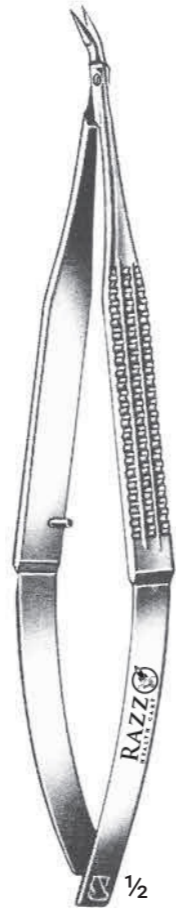

RSA 11.14
Angled up
120mm/4 3/4"

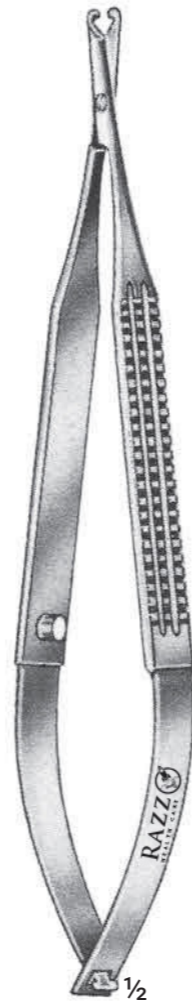

RSA 11.15
Straight
120mm/4 3/4"

RSA 11.16
Straight
160mm/6 1/4"

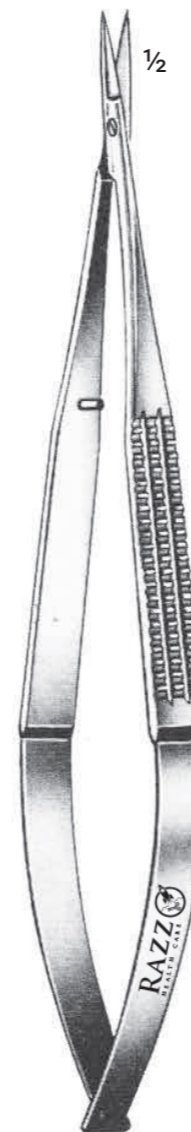

RSA 11.17
Curved
160mm/6 1/4"

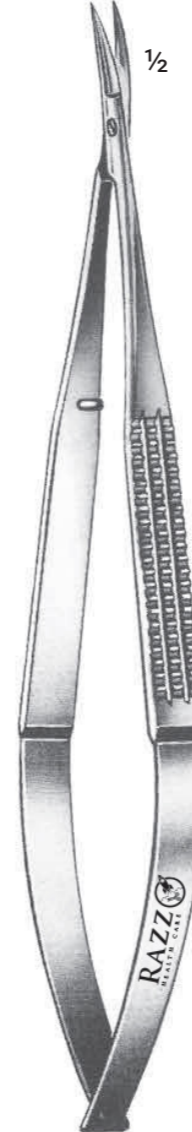

RSA 11.18
Straight
160mm/6 1/4"

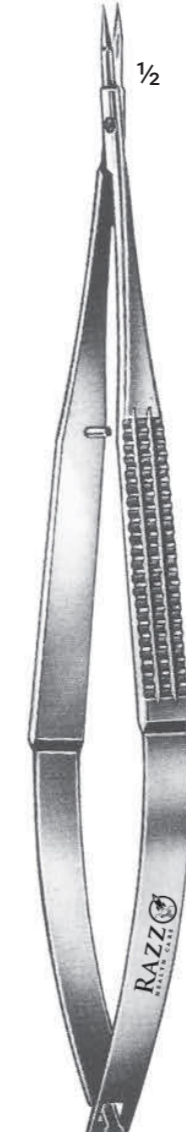

RSA 11.19
Curved
160mm/6 1/4"

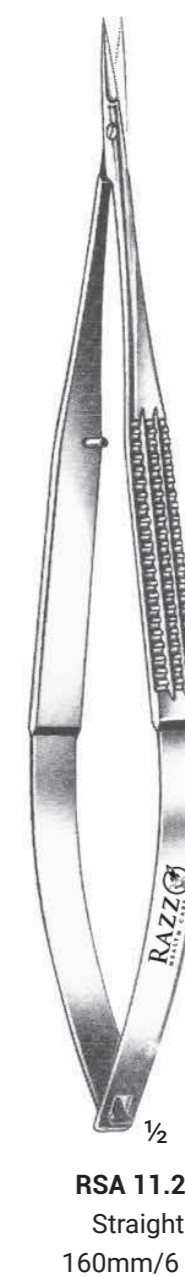

RSA 11.20
Straight
160mm/6 1/4"

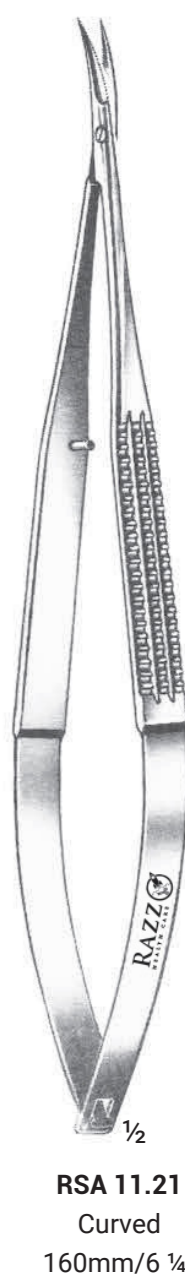

RSA 11.21
Curved
160mm/6 1/4"



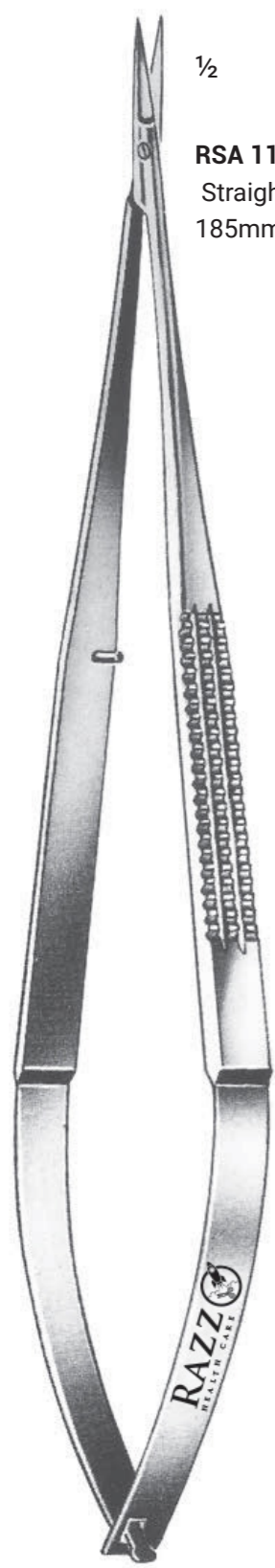

1/2
RSA 11.22
 Straight
 185mm/7 1/4"

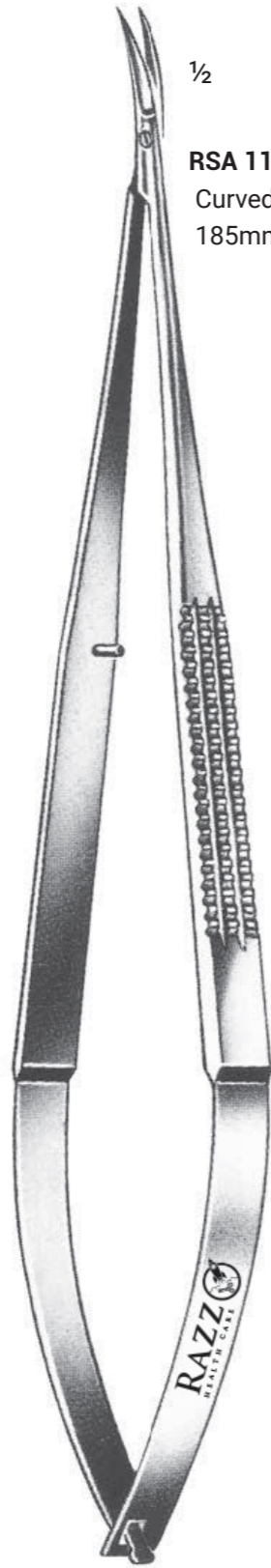

1/2
RSA 11.23
 Curved
 185mm/7 1/4"

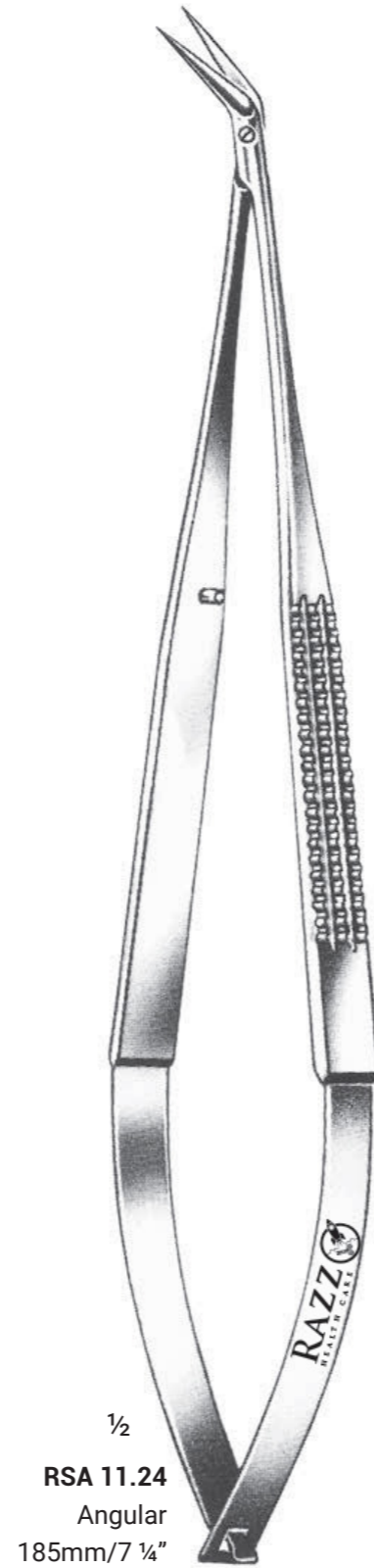

1/2
RSA 11.24
 Angular
 185mm/7 1/4"

RSA 11.25
 Straight
 160mm/6 1/4"



RSA 11.26
 Curved
 160mm/6 1/4"



RSA 11.27
 Straight
 160mm/6 1/4"



1/2
RSA 11.28
 Curved
 160mm/6 1/4"

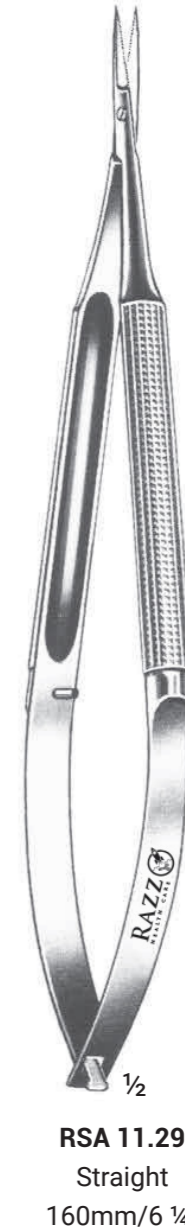

1/2
RSA 11.29
 Straight
 160mm/6 1/4"



1/2
RSA 11.30
 Curved
 160mm/6 1/4"

SCISSORS

MICRO VASCULAR POTTS SCISSORS

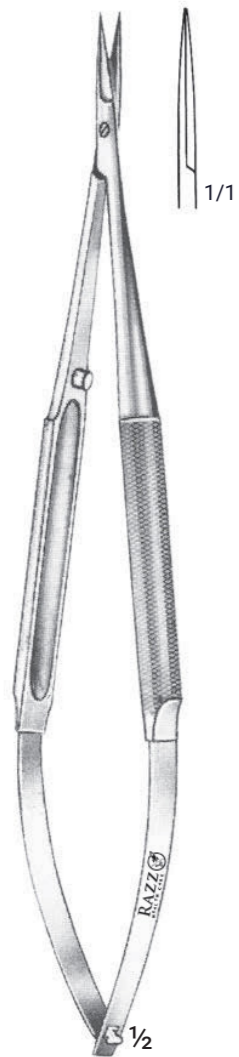

RSA 11.31
Straight
145mm/5 3/4"

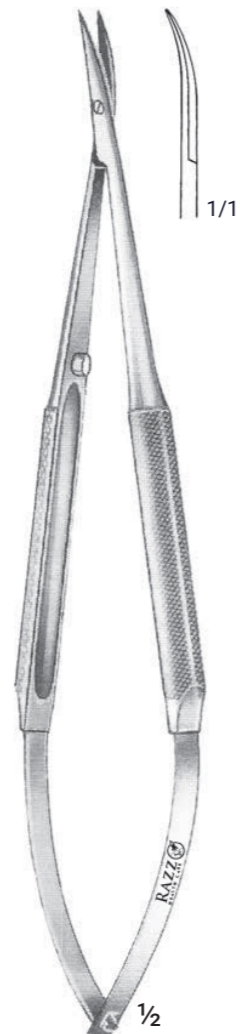

RSA 11.32
Curved
145mm/5 3/4"



RSA 11.33
Curved
145mm/5 3/4"



RSA 11.40
180mm/7"



RSA 11.41
180mm/7"



RSA 11.42
180mm/7"



RSA 11.43
180mm/7"



RSA 11.44
180mm/7"

Micro Potts Scissors
Spring Type, Round Handle

NERVE ROOT RETRACTORS



SCOVILLE
RAH 42.50
230mm/9"



HOLSHER
RAH 42.51
240mm/9 1/2"



LOVE
RAH 43.01 - RAH 43.03
220mm/8 3/4"



SCOVILLE
RAH 43.51
230mm/9"



LOVE
RAH 44.52
210m/8 1/4"

LAMINA SPREADERS



CLOWARD
LAMINA SPREADER
MAX.OPEN 20mm
RAH 49.25 - 135mm/5 1/4"



CLOWARD
CERVICAL VERTEBRA
SPREADER
MAX.OPEN 15mm
RAH 49.50 -160mm/6 1/4"

LAMINA SPREADERS



CLOWARD
RAH 49.75 -160mm/6 1/4"

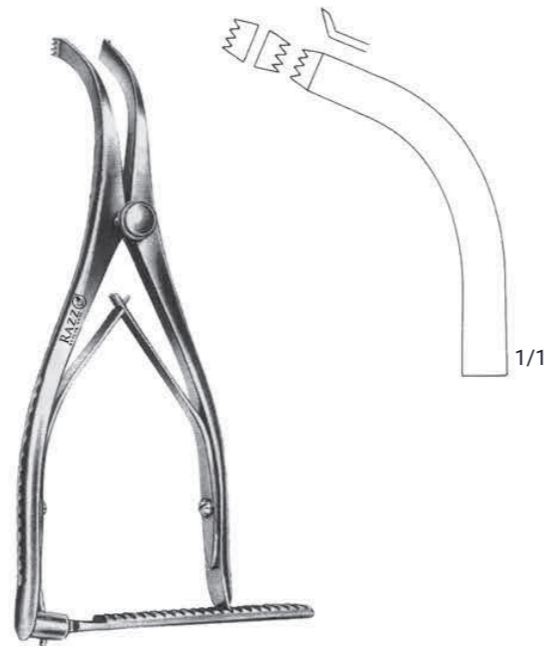

INGE
RAH 50.05 -160mm/6 1/4"

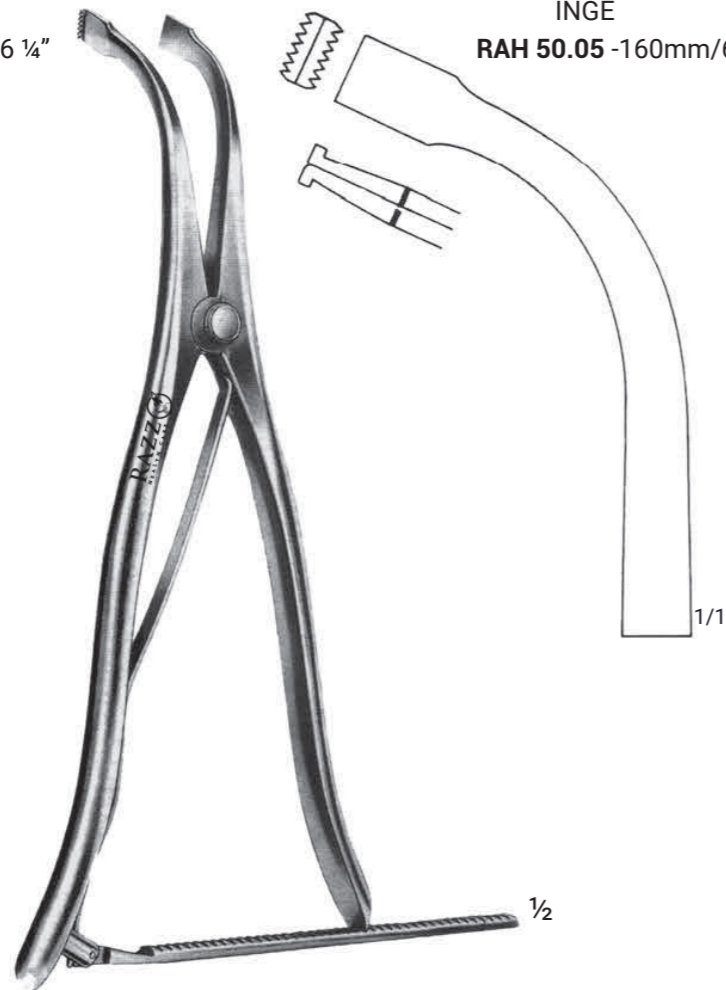

INGE
RAH 50.27 -270mm/10 3/4"

CLOWARD CERVICAL RETRACTORS

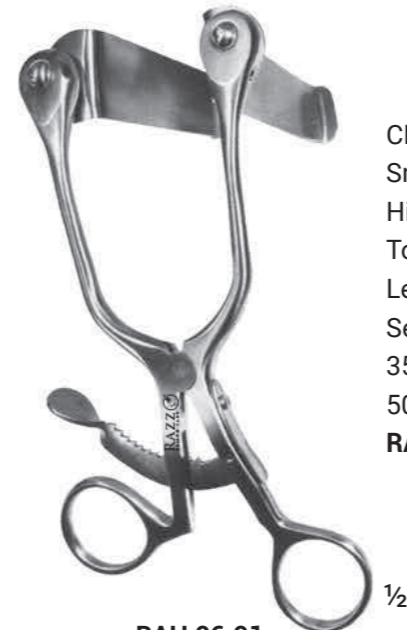

RAH 06.91

CLOWARD
Small Cervical Retractor
Hinged Arms
Total Opening 65mm/2 1/2"
Length 170mm/6 3/4"
Set of 12 Blades
35mm,40mm,45mm
50mm,55mm,60mm
RAH 06.91



RAH 06.90

CLOWARD
Large Cervical Retractor
Hinged Arms
Total Opening 115mm/4 1/2"
Length 255mm/10"
Set of 10 Blades
60mm,40mm,45mm
50mm,55mm,60mm
RAH 06.90



CERVICAL HEMILAMINECTOMY RETRACTORS

MICRO LUMBAR RETRACTORS



SCOVILLE
(Hemilaminectomy Retractor)
Arms Long 5"
Total Opening 5"
Hooks 2" & 3"
Blades
wide 1", Deep 2 1/2"

RAH 40.55



SCOVILLE
(Cervical Disc Retractor)
Arms Long 5"
Total Opening 5"
Hooks 1 1/2" & 2 3/4"
Meyering Type Blades
wide 1", Deep 2"
wide 1", Deep 3 1/4"
wide 1", Deep 3 1/2"

RAH 40.56

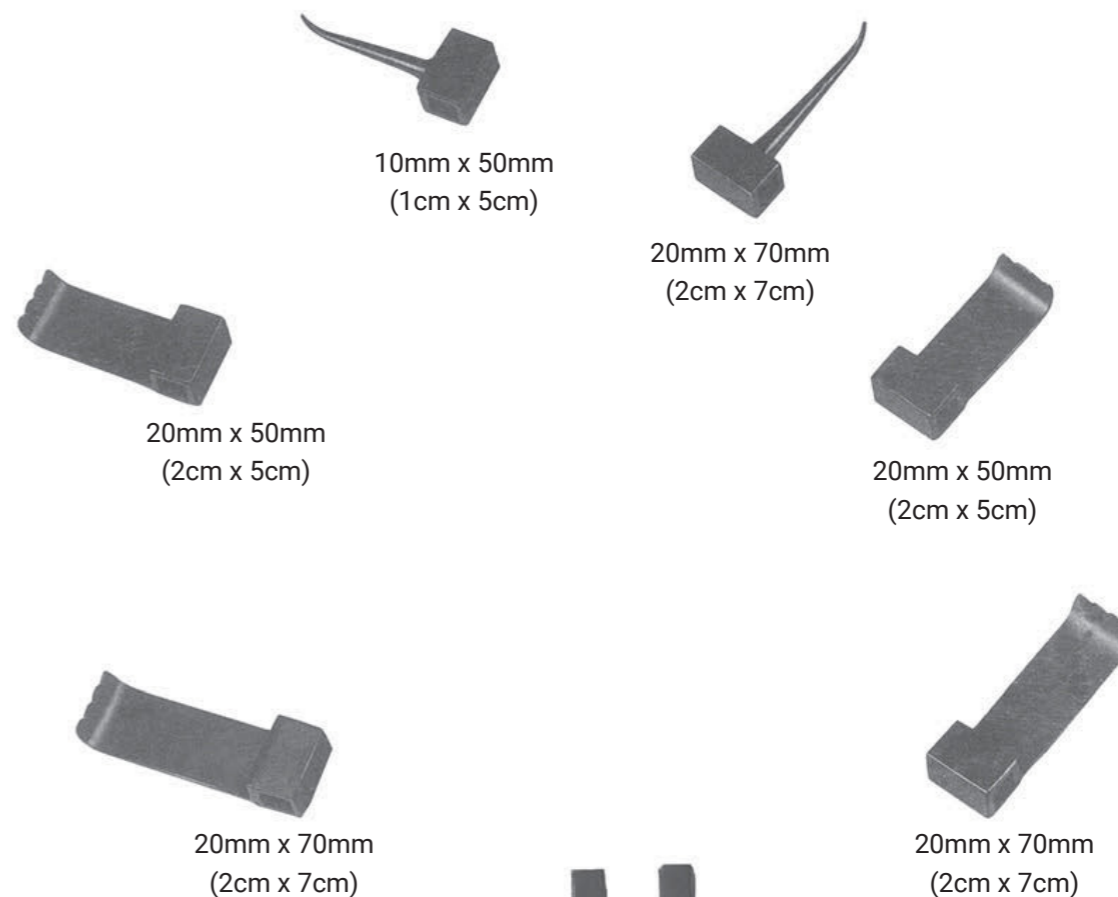

10mm x 50mm
(1cm x 5cm)

20mm x 70mm
(2cm x 7cm)

20mm x 50mm
(2cm x 5cm)

20mm x 50mm
(2cm x 5cm)

20mm x 70mm
(2cm x 7cm)

20mm x 70mm
(2cm x 7cm)

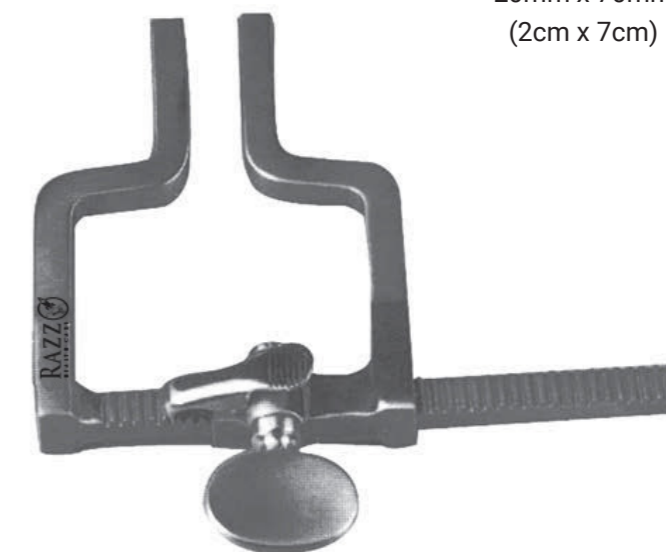

DR.RAMANI'S

(Modified Micro Lumbar Retractor with Blades)
RAH 24.57

INSTRUMENTS FOR ANTERIOR CERVICAL

INSTRUMENTS FOR ANTERIOR CERVICAL

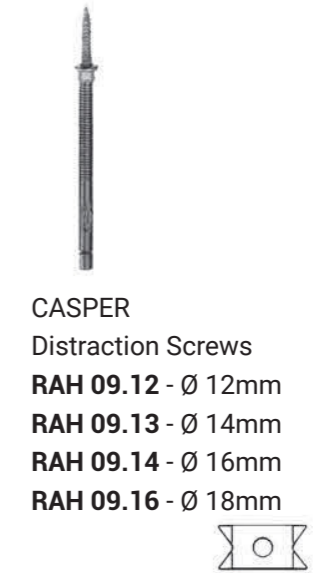

INSTRUMENTS FOR ANTERIOR CERVICAL



CASPER
Tampers
200mm/8"
RAH 09.18 - Ø 3mm
RAH 09.19 - Ø 5mm
RAH 09.20 - Ø 8mm



CASPER
Colli Muscle Dissector
with Fiber Handle
180mm/7"
RAH 09.21



CASPER
Vertebral Dissector
with Fiber Handle
205mm/8"
RAH 09.24 - 45°
RAH 09.25 - 60°

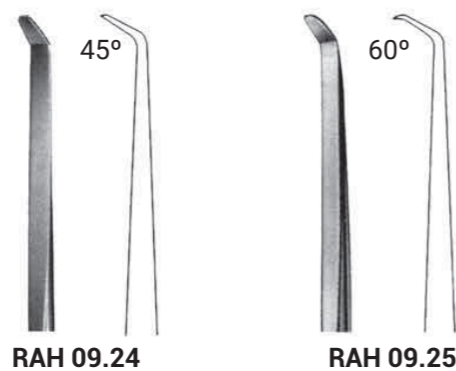

INSTRUMENTS FOR ANTERIOR CERVICAL

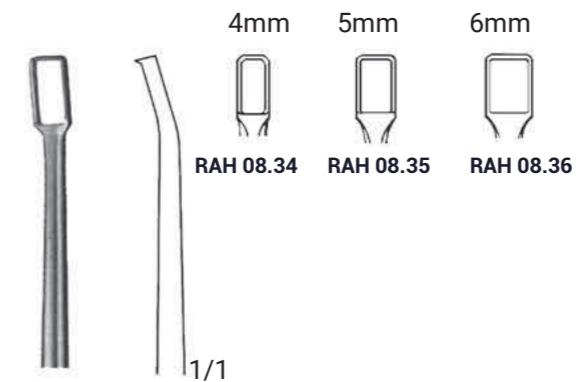

CASPER
Curette Toothed
220mm/8 3/4"
RAH 08.34 - 4mm
RAH 08.35 - 5mm
RAH 08.36 - 6mm



CASPER
Scoop
220mm/8 3/4"



3.6 x 5mm
RAH 07.73 - Straight
RAH 07.74 - Curved

4.4 x 6.2mm
RAH 07.75 - Straight
RAH 07.76 - Curved

5.2 x 7.3mm
RAH 07.77 - Straight
RAH 07.78 - Curved

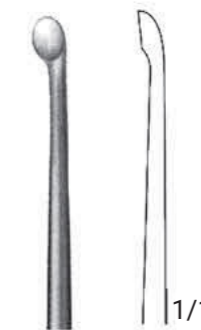

3.6 x 5mm
RAH 07.73

4.4 x 6.2mm
RAH 07.75

5.2 x 7.3mm
RAH 07.77



3.6 x 5mm
RAH 07.74

4.4 x 6.2mm
RAH 07.76

5.2 x 7.3mm
RAH 07.78

CRANIAL DRILLS

SKULL CHANNELING FORCEPS



EXTENSION PIECE
RAH 53.05

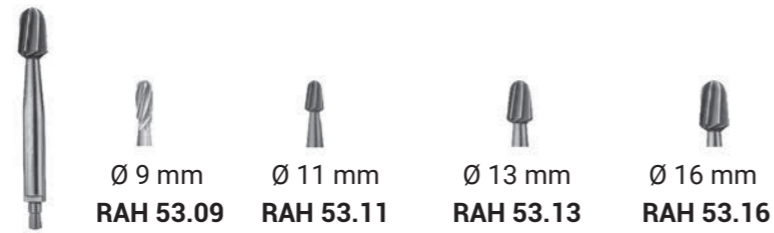

Ø 9 mm RAH 53.09
Ø 11 mm RAH 53.11
Ø 13 mm RAH 53.13
Ø 16 mm RAH 53.16



BRACE ONLY
RAH 53.03

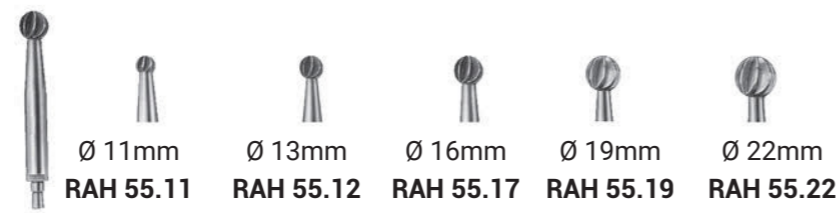

Ø 11mm RAH 55.11
Ø 13mm RAH 55.12
Ø 16mm RAH 55.17
Ø 19mm RAH 55.19
Ø 22mm RAH 55.22

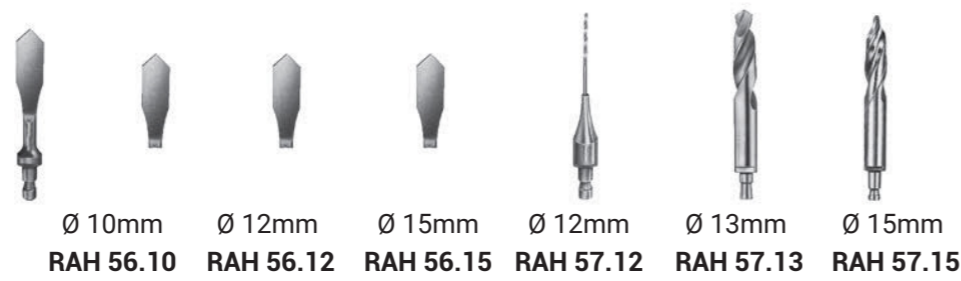

Ø 10mm RAH 56.10
Ø 12mm RAH 56.12
Ø 15mm RAH 56.15
Ø 12mm RAH 57.12
Ø 13mm RAH 57.13
Ø 15mm RAH 57.15

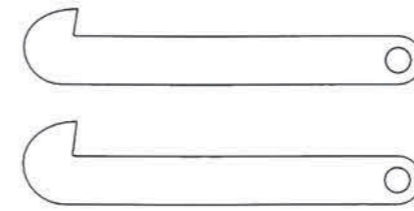

DE VILBISS
1 small Blade
1 Large Blade
210mm/8 1/4"
RAH 56.34



DAHIGREN
2 spare Blades
210mm/8"
RAH 56.35

TRACTION TONGS & SKULL TONGS

SELF -RETAINING RETRACTORS



CRUTCHFIELD
Adult with wrench
RAH 70.74

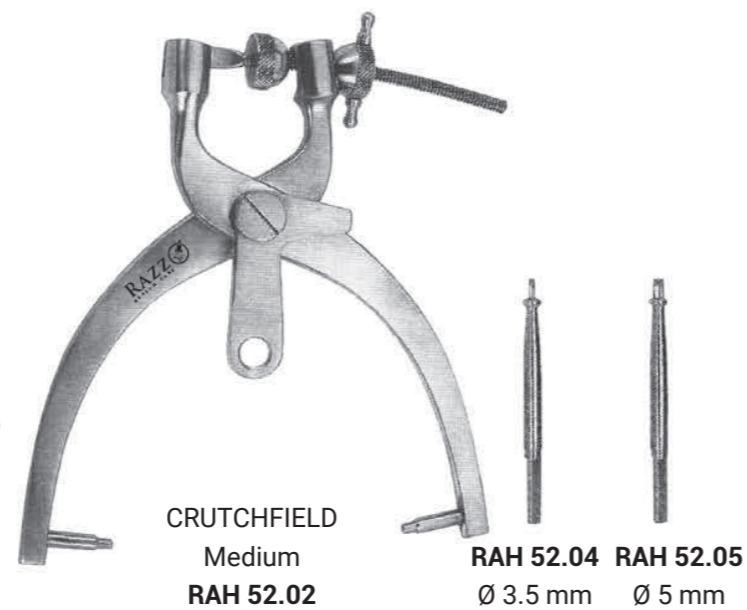

CRUTCHFIELD
Medium
RAH 52.02

RAH 52.04 RAH 52.05
Ø 3.5 mm Ø 5 mm



CRUTCHFIELD
Child
RAH 52.01

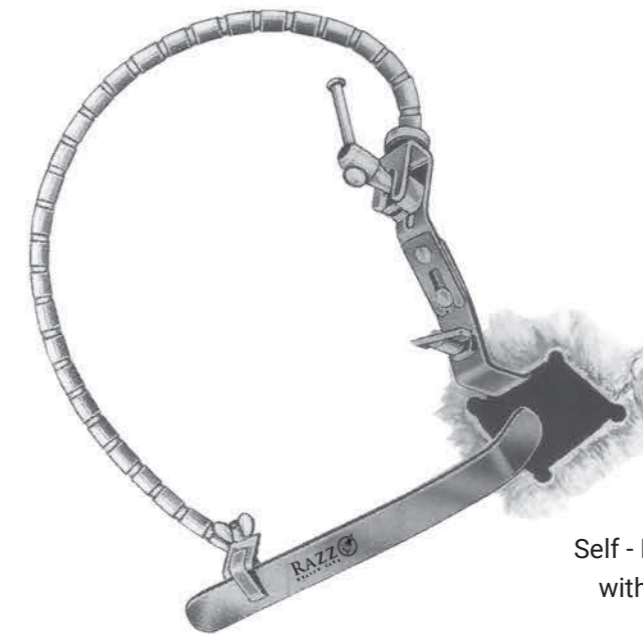

RLR 60.01

YASARGIL -LEYLA
Self - Retaining Brain Retractor
with 1 Flexible Single Arm

- Consisting of:
- RLR 60.04 -No. 1
 - RLR 60.05 -No. 1
 - RLR 60.07 -No. 1
 - RLR 60.08 -No. 1
 - RLR 60.09 -No. 1
 - RLR 60.10 -No. 1

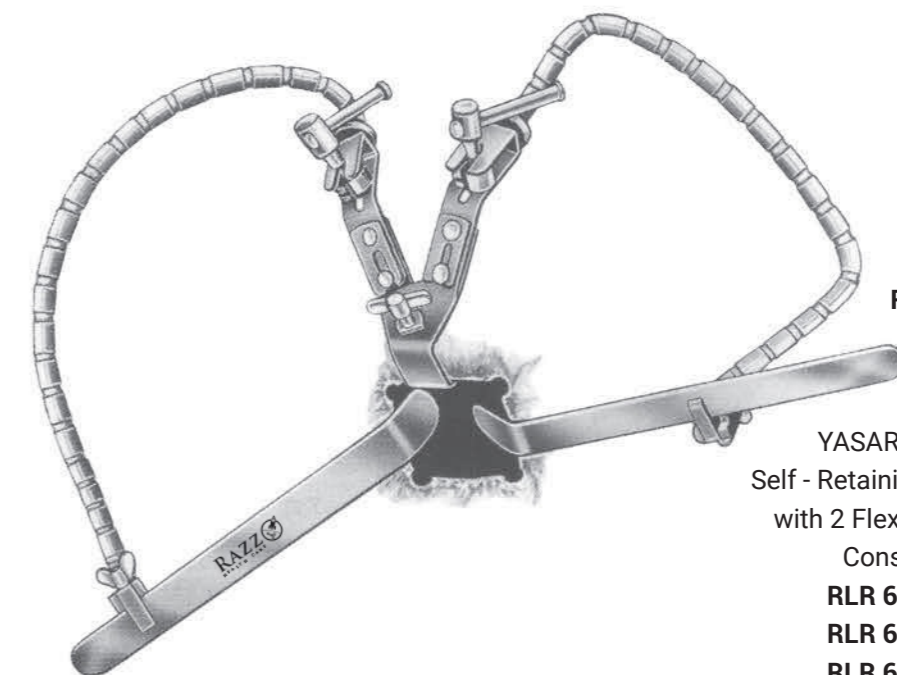

RLR 60.02

YASARGIL - LEYLA
Self - Retaining Brain Retractor
with 2 Flexible Double Arm

- Consisting of :
- RLR 60.04 -No. 2
 - RLR 60.06 -No. 1
 - RLR 60.07 -No. 1
 - RLR 60.08 -No. 1
 - RLR 60.09 -No. 1
 - RLR 60.10 -No. 1
 - RLR 60.11 -No. 1



RLR 60.04
Flexible Arm

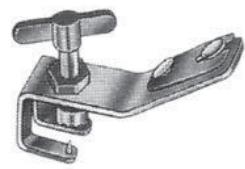

RLR 60.05
Fixation Base For Single Arm



RLR 60.06
Fixation Base For Double Arm

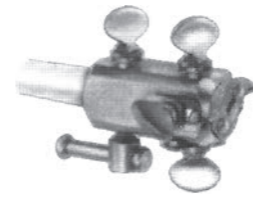

RLR 60.07
Skull Mount For Double Arm



RLR 60.08
Holding Rod

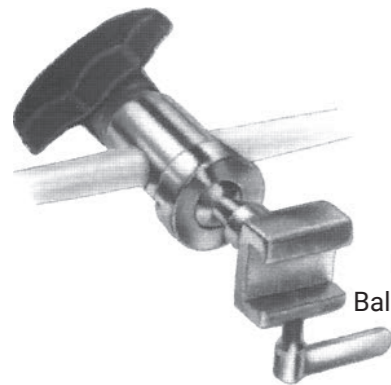

RLR 60.09
Ball Joint Socket



RLR 60.10
Round Shaft Brain Spatulas Support



RLR 60.11
Flat Brain Spatulas Support

YASARGIL
Spring Hook for Galae Fixation with
Bulldog Clamp, Be Fastened to
Covering Drap

RAH 61.01 -310mm/12 1/4"
RAH 61.02 -410mm/16"



MAYFIELD SKULL CLAMPS & HEADREST SYSTEM

MAYFIELD SKULL CLAMPS & HEADREST SYSTEM



MAYFIELD SKULL CLAMP

3 Pin Point Rigid Cranial Fixation

- 1) Provide Visual Indication of Clamping Forceps on All 3 Skull Pins
- 2) Adjust Force on All 3 Skull Pins
- 3) Equal of Pins Ensure Firm Skull Positioning and Fixation

RAH 71.10

MAYFIELD ULTRA BASE UNIT
Support/Mounting Device
Facilitates Attachment of Skull
Clamps Headrest Systems to theRAH 71.12
RAH 71.13MAYFIELD ADULT HORSESHOE
Headrest with Table AttachmentHorseshoe Shaped Headrest Provides
Cranial Supports in the prone OR Supine
Position for Adult

RAH 70.87

MAYFIELD INFINITY SKULL CLAMP
3 Pin Point Rigid Cranial Fixation.Added Length and Curved
Contours of the Skull Clamp
Upright Allow Clamp to Better
Interface with the Horseshoe
Headrests of the Infinity Support
Systems

RAH 70.89

MAYFIELD CHILD HORSESHOE
Headrest with Table AttachmentHorseshoe Shaped Headrest Provides
Cranial Supports in the prone OR Supine
Position for Child

RAH 70.88

MAYFIELD MODIFIED SKULL CLAMP
3 Pin Point Rigid Cranial Fixation.

- 1) Flexibility and Safety in Positioning
of Skull Pins Around Critical Areas.
- 2) Quick - Release Lock Enables Easy Removal

RAH 70.90

MAYFIELD SKULL CLAMPS & HEADREST SYSTEM



WILSON FRAME
For Spine Surgery
RAH 70.80



DOUBLE BALL SOCKET
Attachment
Horse - Shoe Type
RAH 70.81



MAYFIELD HORSESHOE HEADREST
with Pulley Traction
RAH 70.82



MAYFIELD NEUROGEN ADAPTOR
Support / Mounting Device that Allow Attachment of Base Units
to the OR Table When Receptacle Hole are Absent OR Inappropriate
Easy Attaches to OR Table Side Railing
RAH 70.83

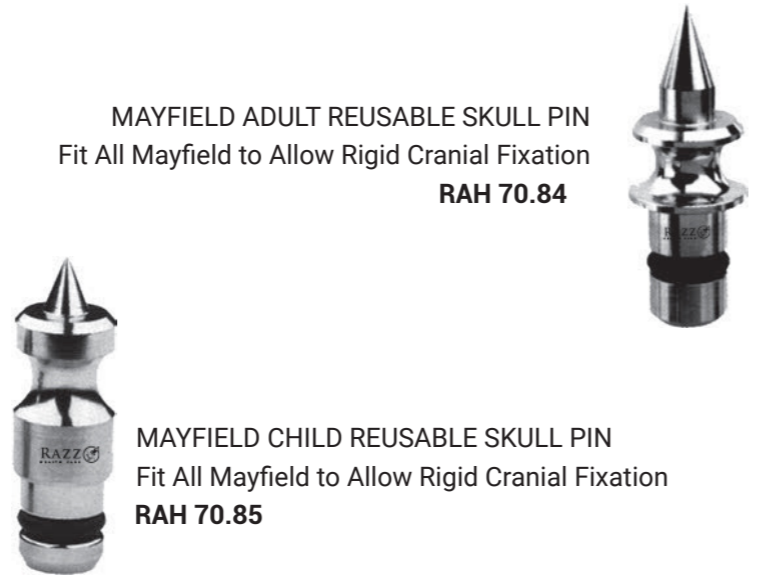

MAYFIELD ADULT REUSABLE SKULL PIN
Fit All Mayfield to Allow Rigid Cranial Fixation
RAH 70.84

MAYFIELD CHILD REUSABLE SKULL PIN
Fit All Mayfield to Allow Rigid Cranial Fixation
RAH 70.85



CARDIOVASCULAR INSTRUMENTS

MICRO BULLDOG CLAMPS

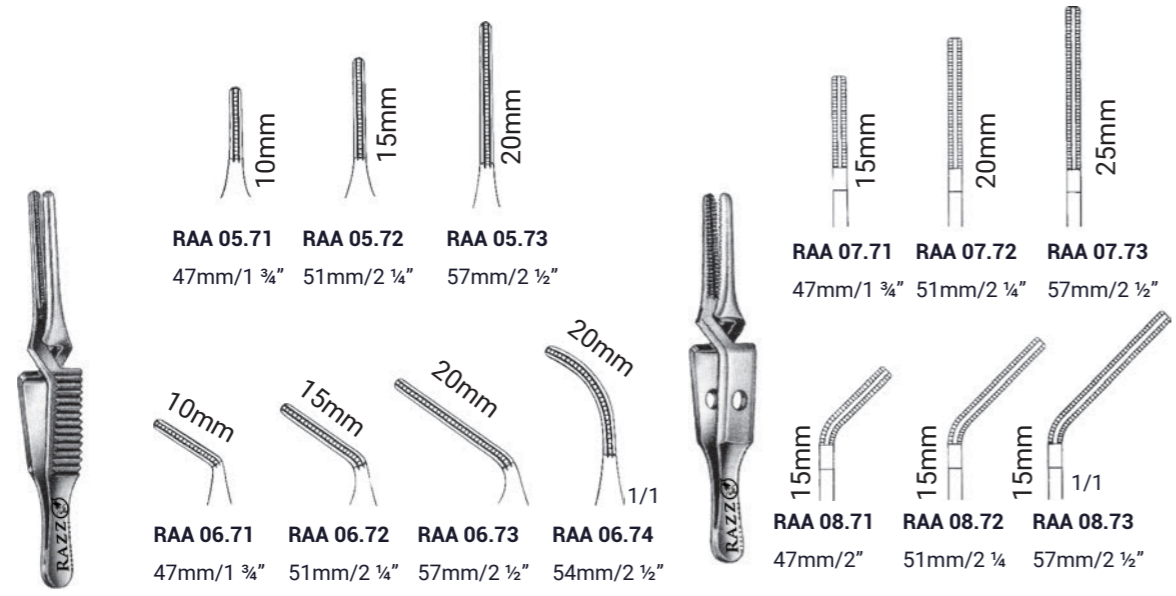

Debakey - Diethrich

Debakey - Diethrich



Applying Forceps
Length 250mm/10"
RAA 04.75



Applying Forceps
Length 250mm/10"
RAA 08.74

DEBAKEY, COOLEY & BULLDOG CLAMPS

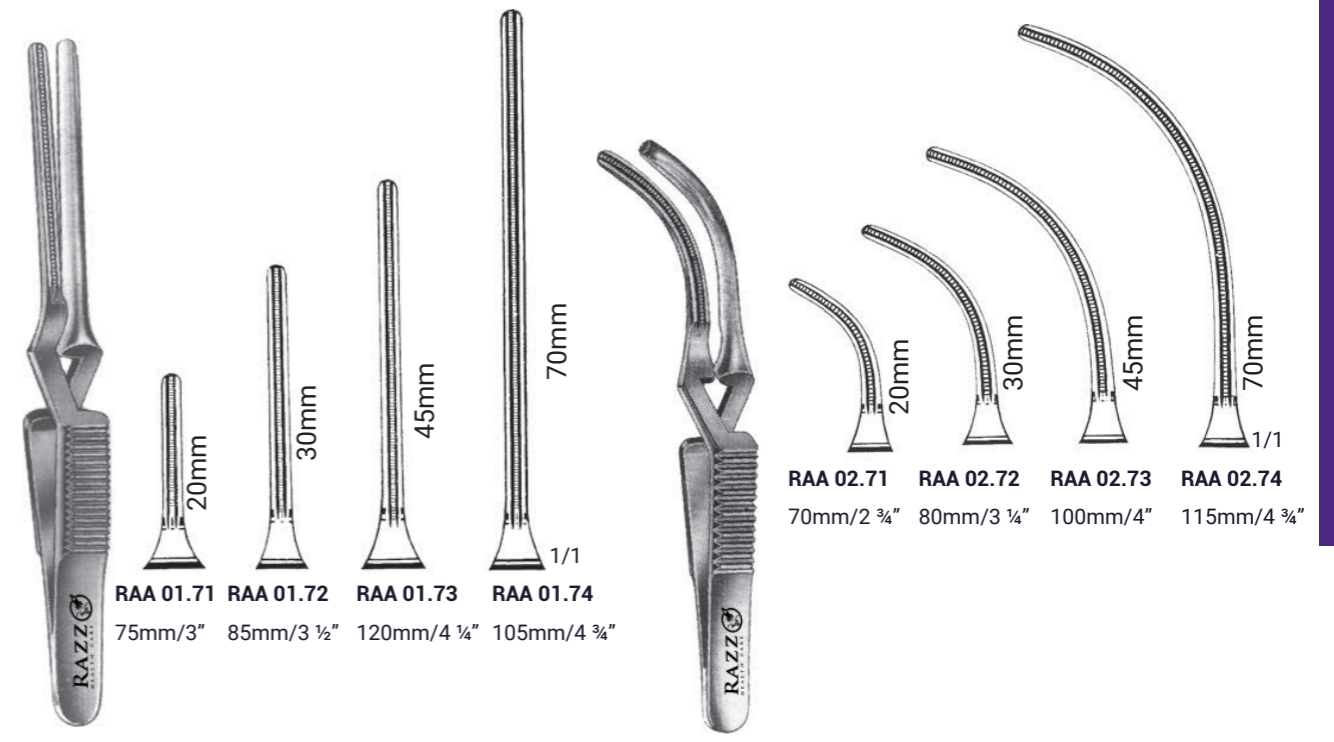

Debakey

Debakey

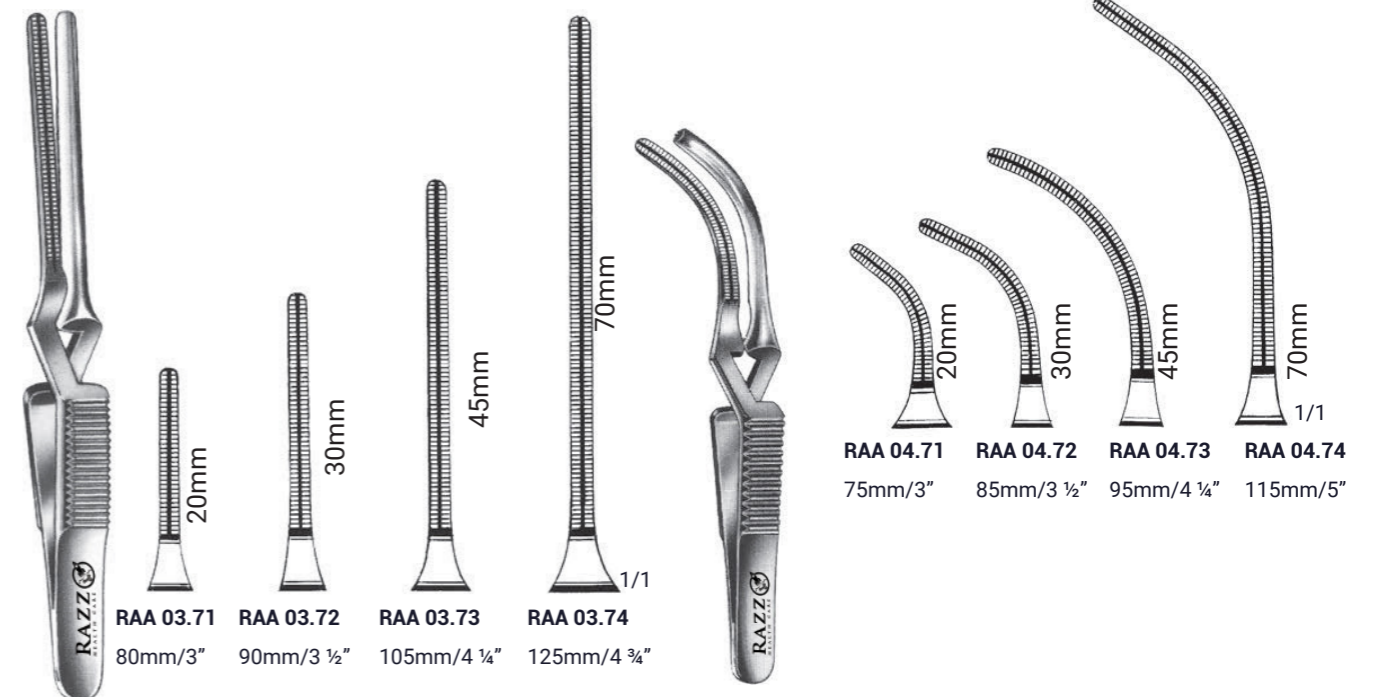

Cooley

Cooley

BULLDOG CLAMPS

ATRAUMATIC BULLDOG CLAMPS

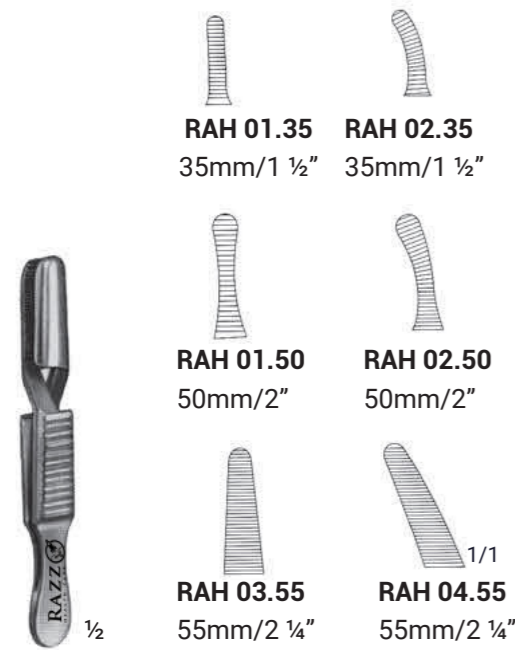

DIEFFENBACH



JOHNS - HOPKINS

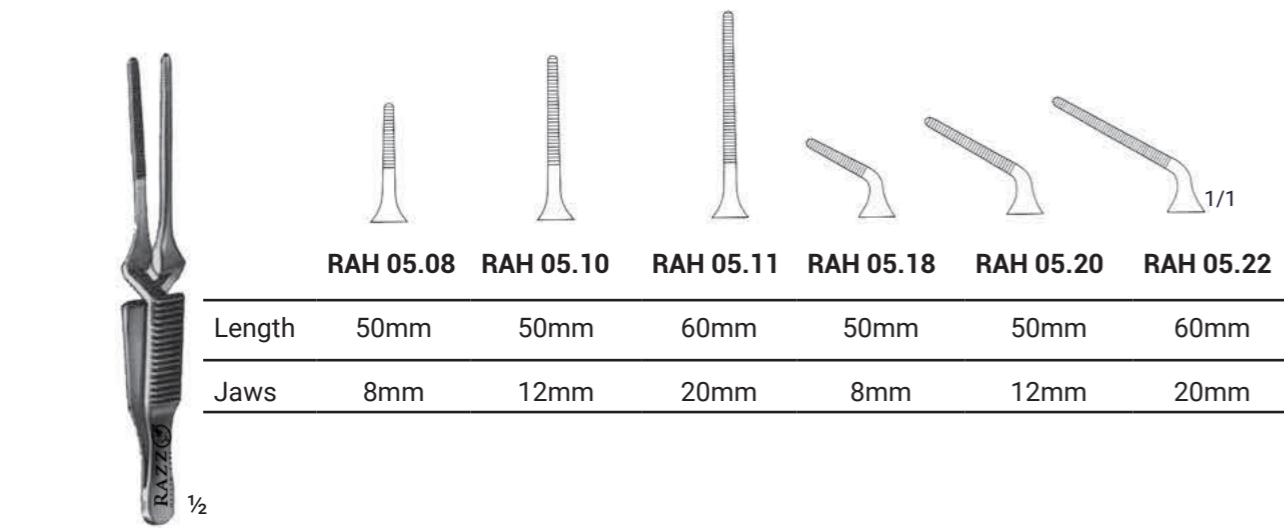
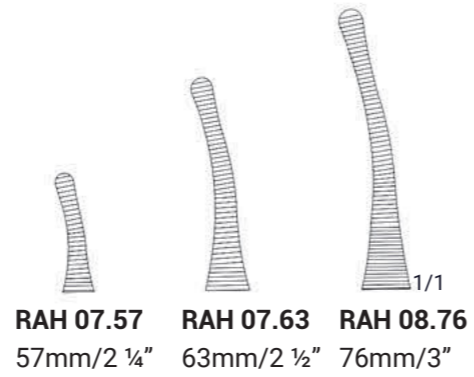

DIETHRIC

	RAH 05.08	RAH 05.10	RAH 05.11	RAH 05.18	RAH 05.20	RAH 05.22
Length	50mm	50mm	60mm	50mm	50mm	60mm
Jaws	8mm	12mm	20mm	8mm	12mm	20mm

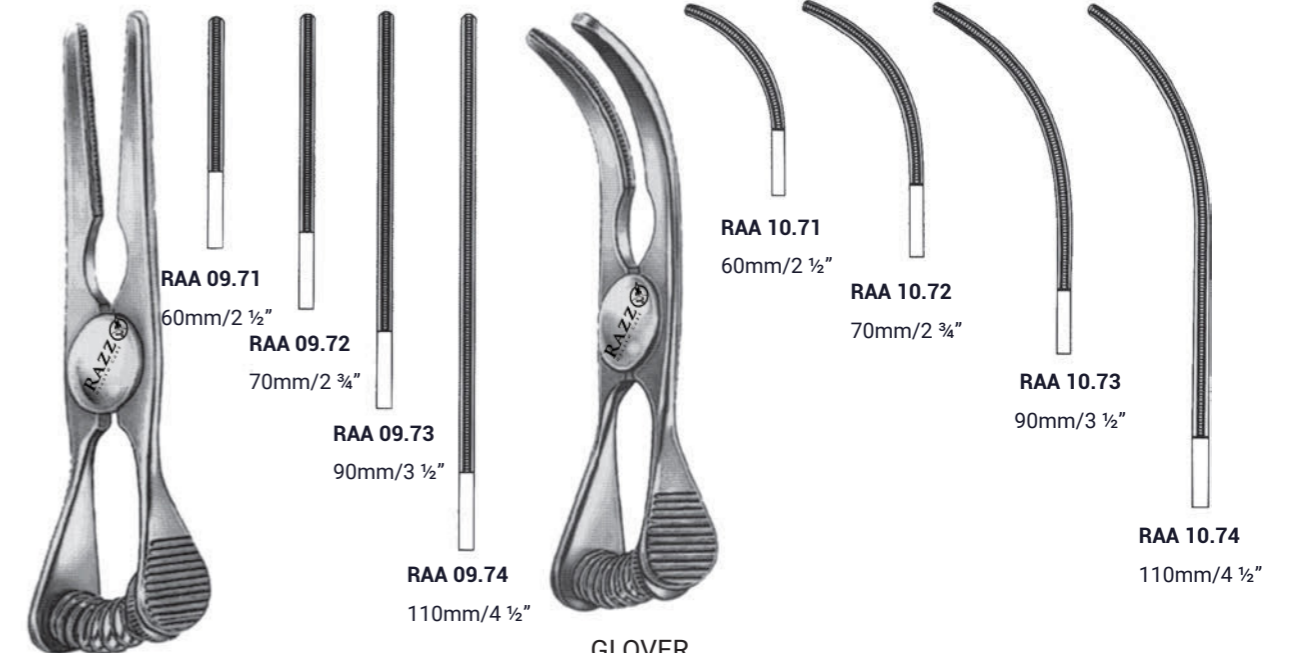

GLOVER

GLOVER

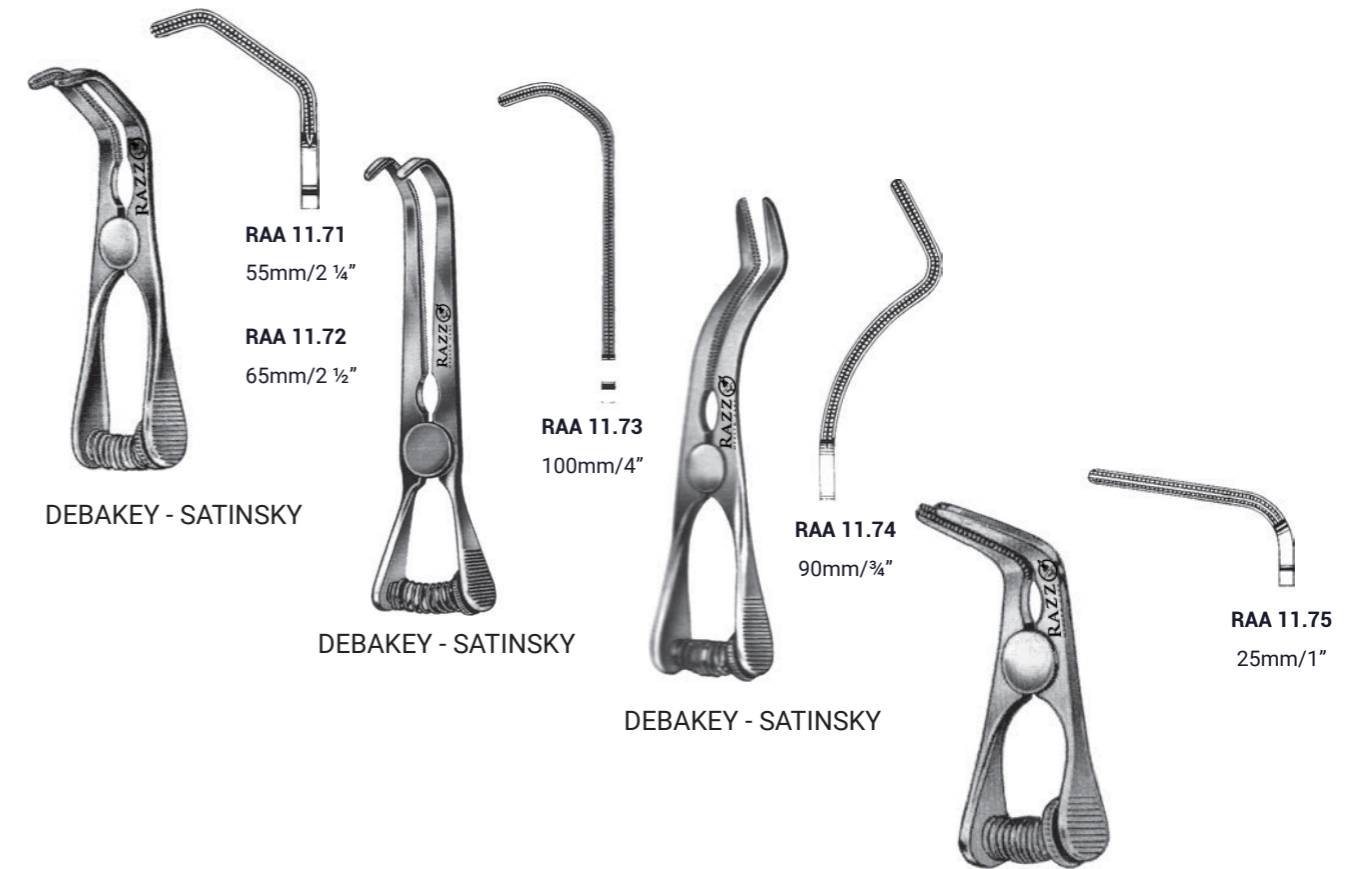

DEBAKEY - SATINSKY

DEBAKEY - SATINSKY

DEBAKEY - SATINSKY

ATRAUMATIC COARCTATION CLAMPS

ATRAUMATIC PERIPHERAL VASCULAR CLAMPS

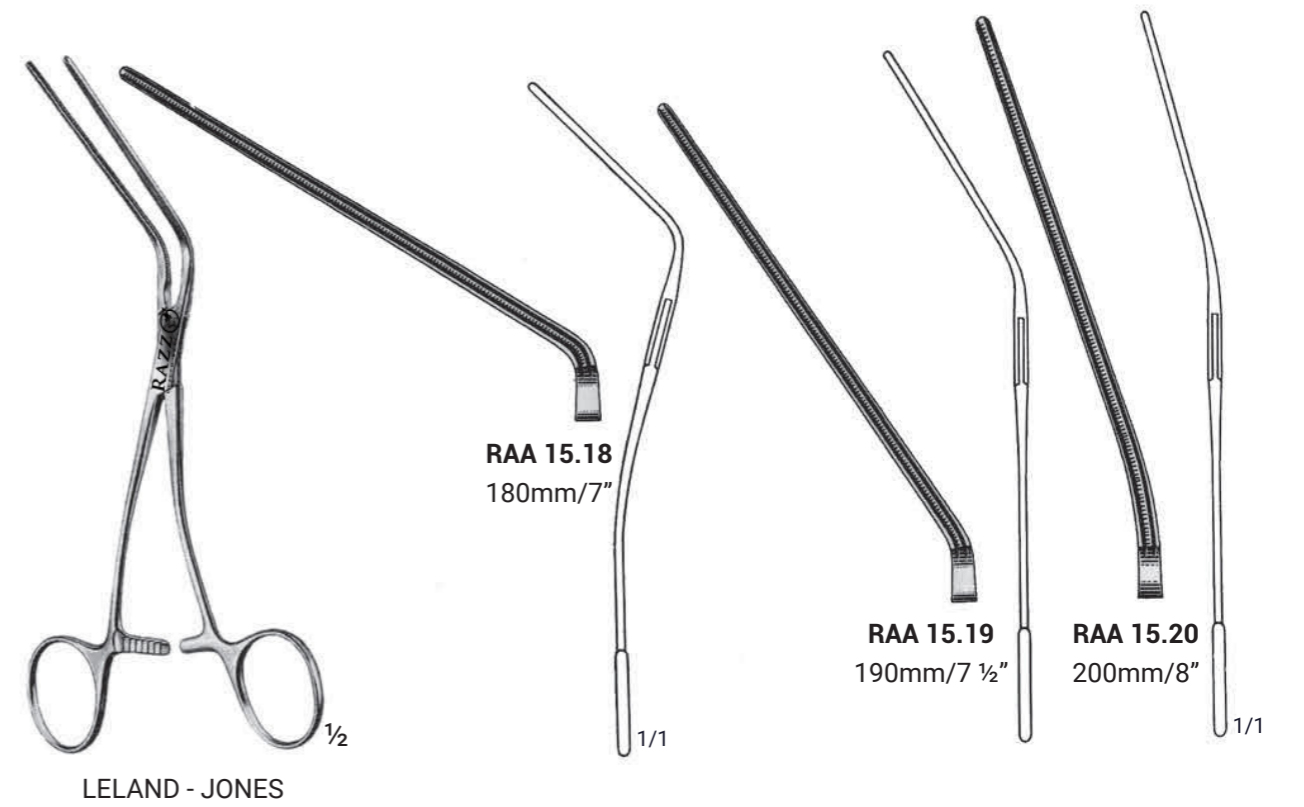

ATRAUMATIC AORTIC ANEURYSM CLAMPS

TANGENTIAL OCCLUSION CLAMP

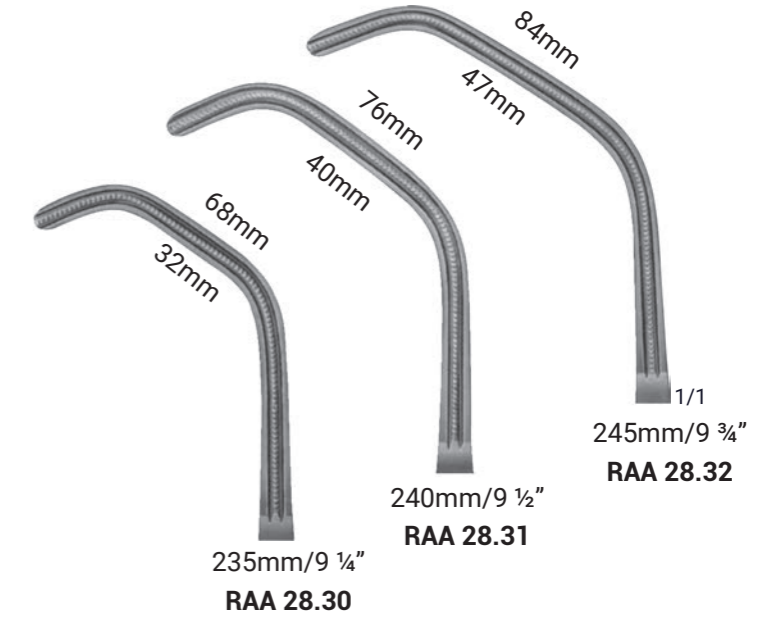
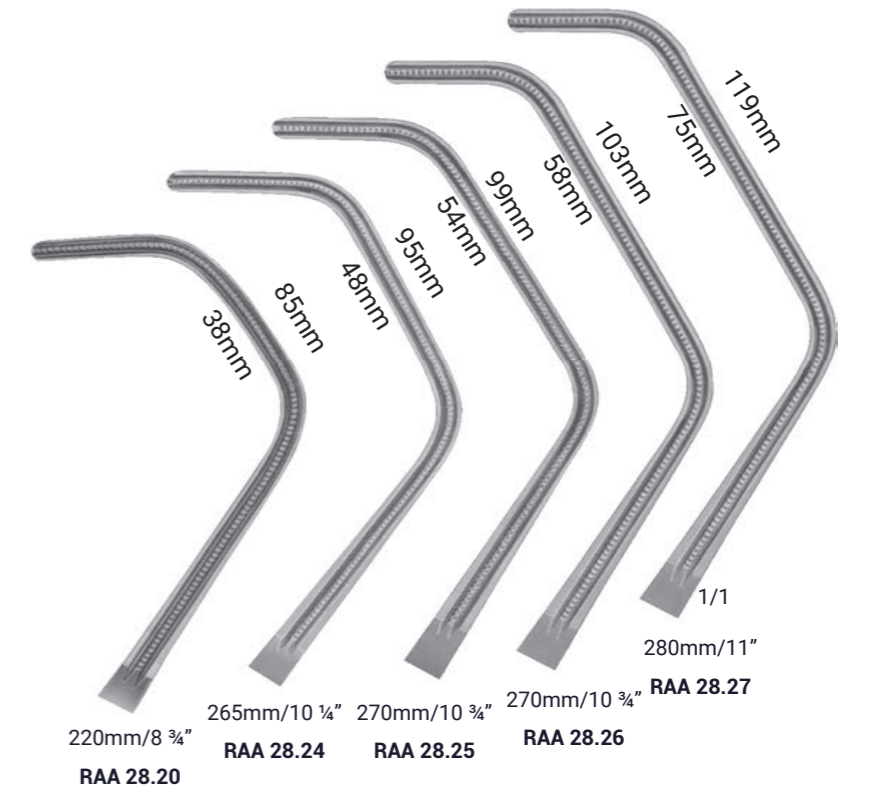

ATRAUMATIC BRONCHUS & AORTIC ANEURYSM CLAMPS

AORTA ANASTOMOSIS CLAMPS

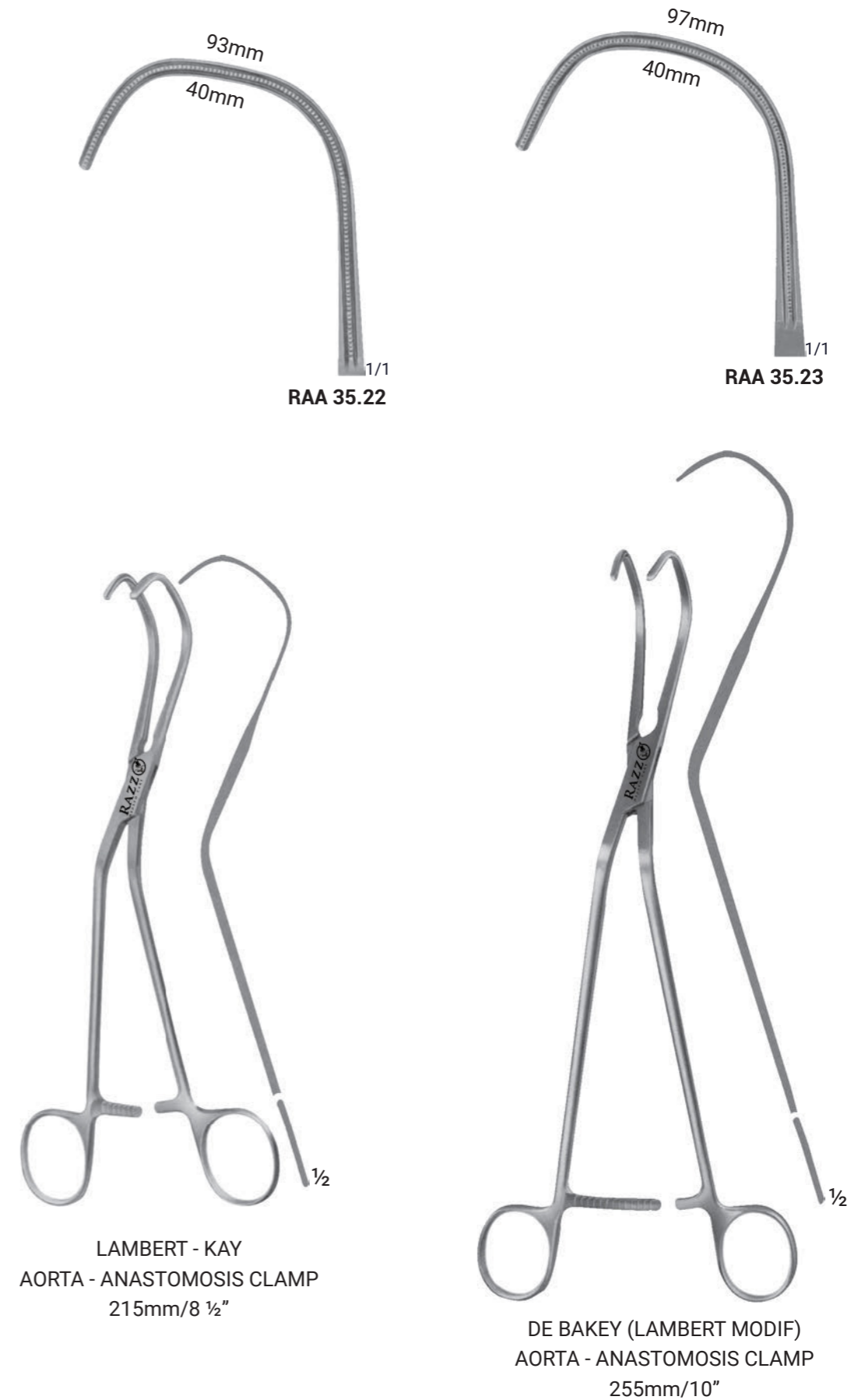
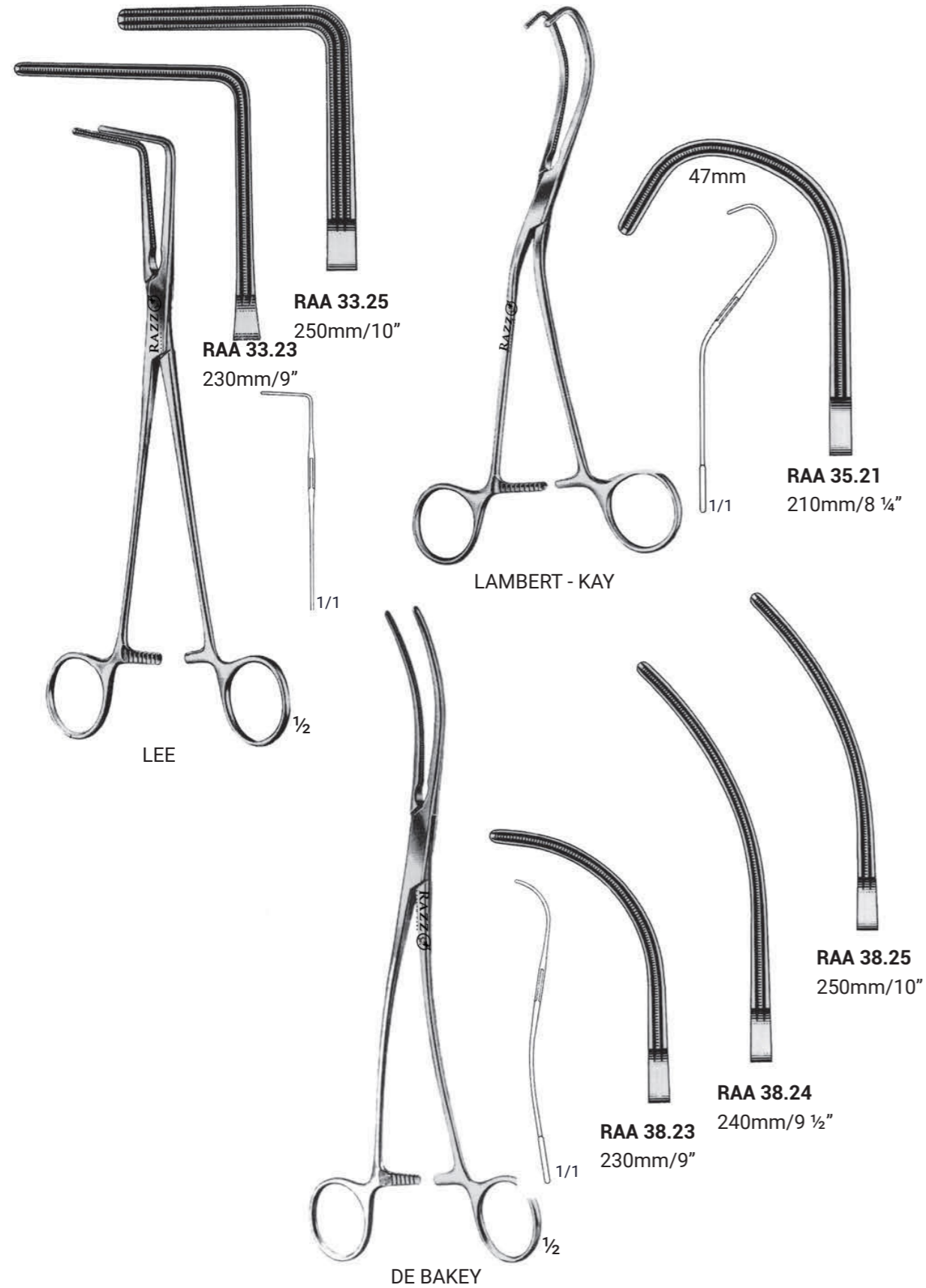

AORTA ANASTOMOSIS CLAMPS

ATRAUMATIC COARCTATION CLAMPS

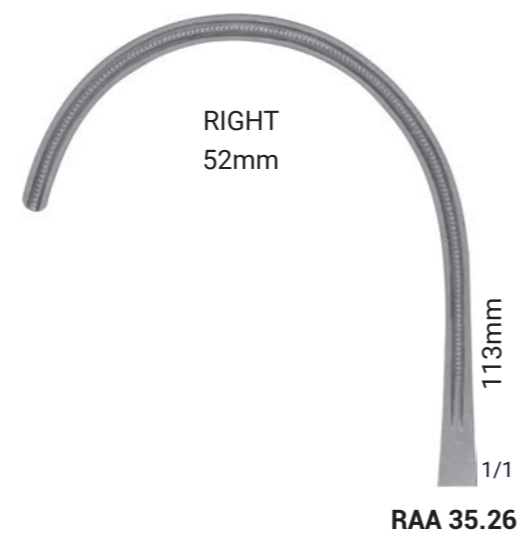
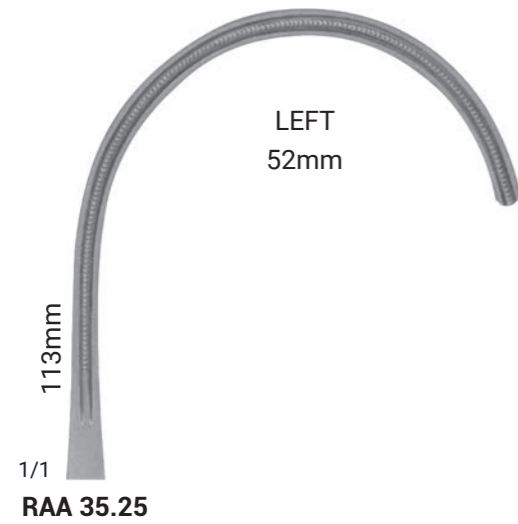

WEBER
AORTA - ANASTOMOSIS CLAMP
260mm/10 1/4"



DE BAKEY 1/2



DE BAKEY 1/2



RAA 39.21
215mm/8 1/2"

RAA 39.23
230mm/9"

RAA 39.27
270mm/10 1/2"

RAA 39.31
315mm/12 1/2"

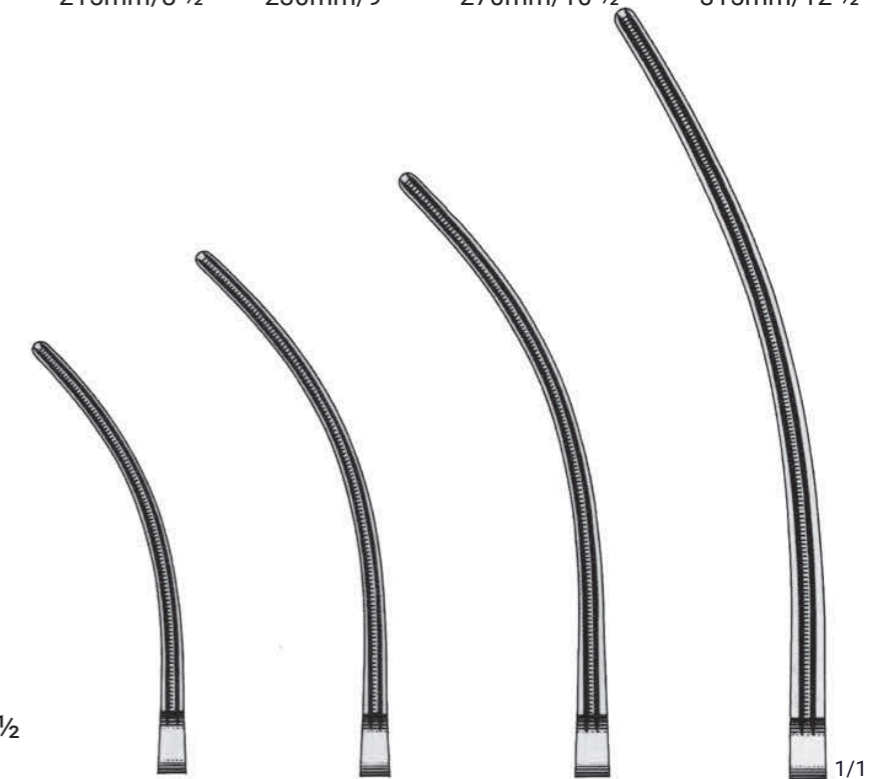

RAA 40.21
215mm/8 1/2"

RAA 40.23
230mm/9"

RAA 40.27
270mm/10 1/2"

RAA 40.31
315mm/12 1/2"

ATRAUMATIC MULTI PURPOSE CLAMPS

ANASTOMOSIS & MULTIPURPOSE CLAMPS PEDIATRIC PATTERNS

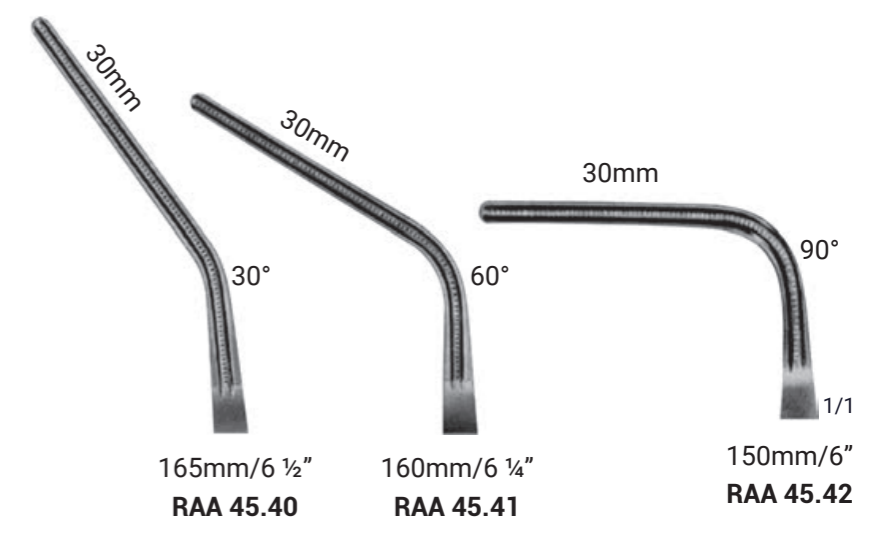
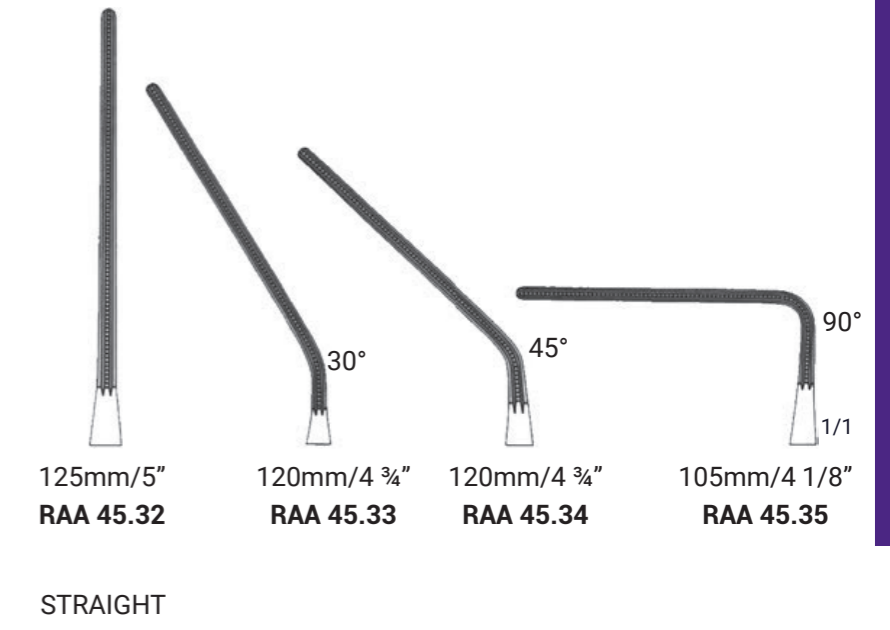
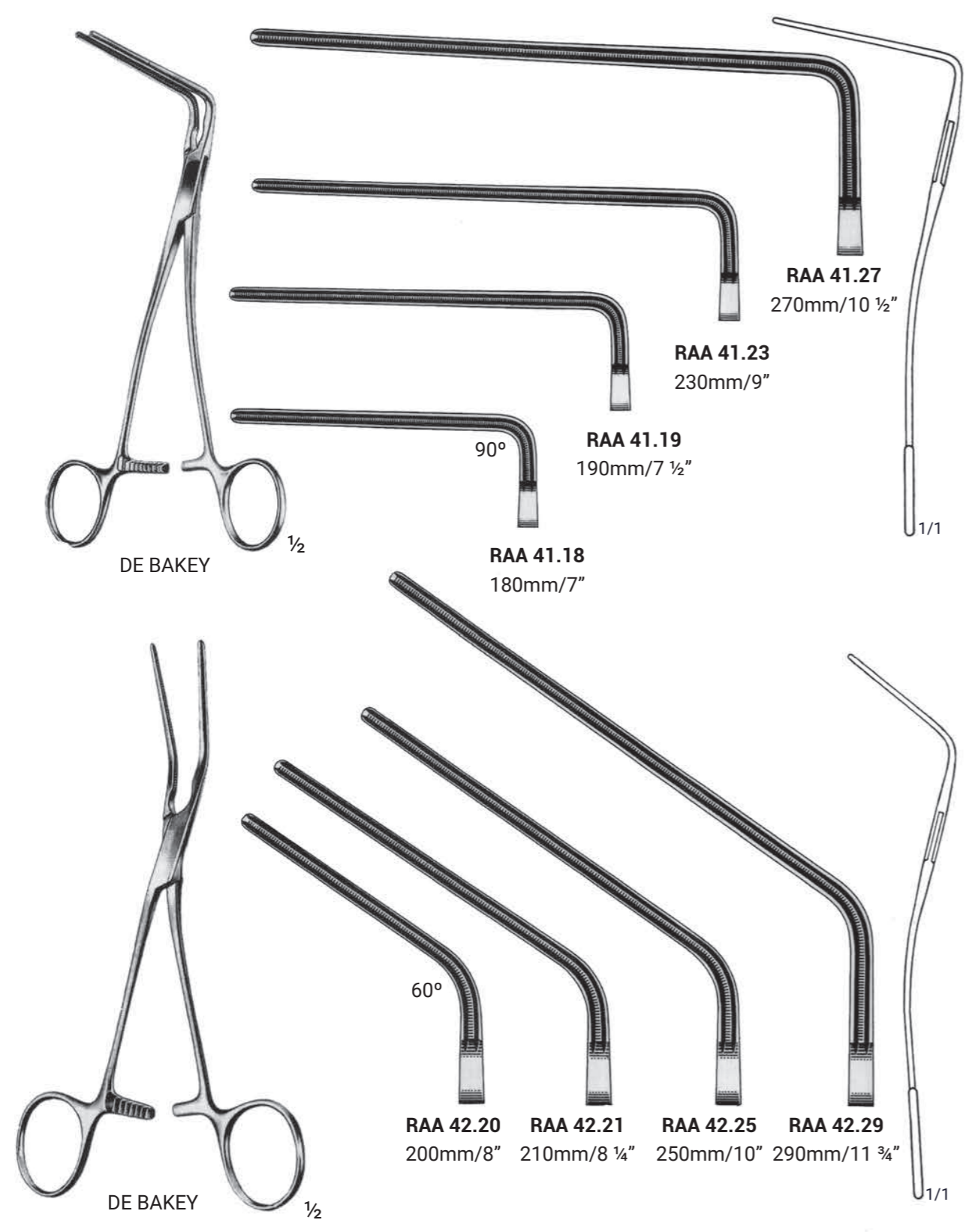

ATRAUMATIC RING HANDLE BULLDOG CLAMPS



DE BAKEY
RAA 57.10
100mm/4"



DE BAKEY
RAA 58.11
110mm/4 1/4"



DE BAKEY
RAA 59.12
120mm/4 3/4"



DE BAKEY
RAA 60.12
120mm/4 3/4"



DE BAKEY
RAA 61.13
130mm/5"



CASTANEDA
ANASTOMOSIS CLAMP



CASTANEDA
MULTI PURPOSE CLAMP

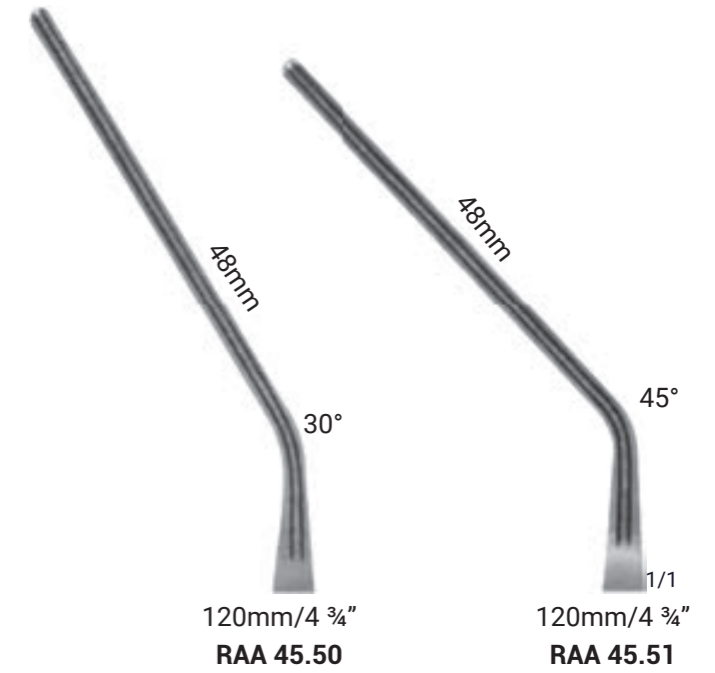

120mm/4 3/4"
RAA 45.50

120mm/4 3/4"
RAA 45.51

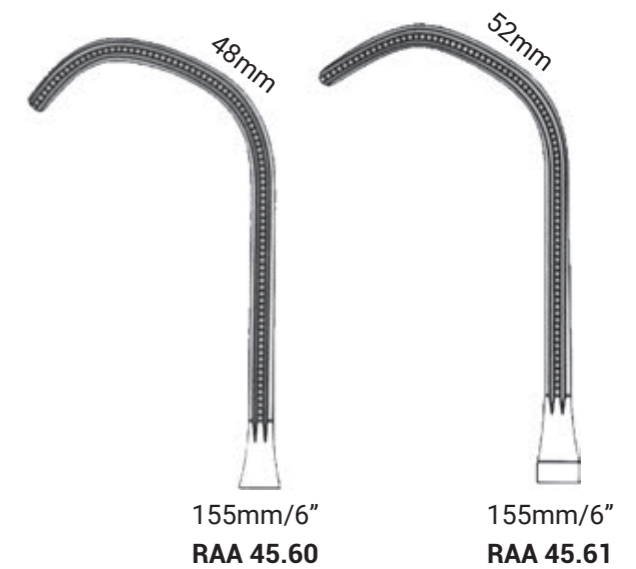

155mm/6"
RAA 45.60

155mm/6"
RAA 45.61

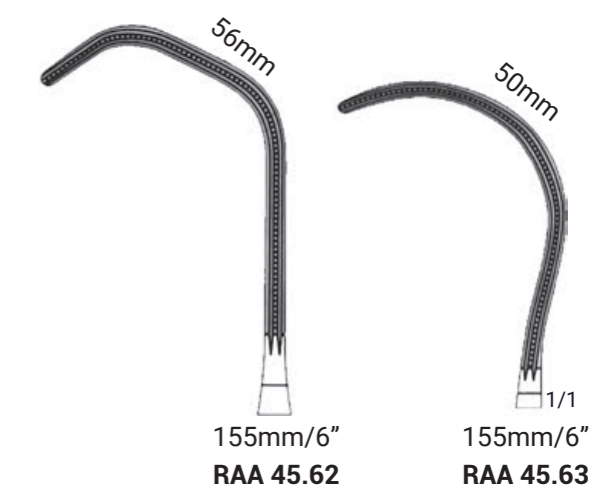

155mm/6"
RAA 45.62

155mm/6"
RAA 45.63

ATRAUMATIC DEBAKEY VASCULAR CLAMPS

ATRAUMATIC CARDIOVASCULAR FORCEPS

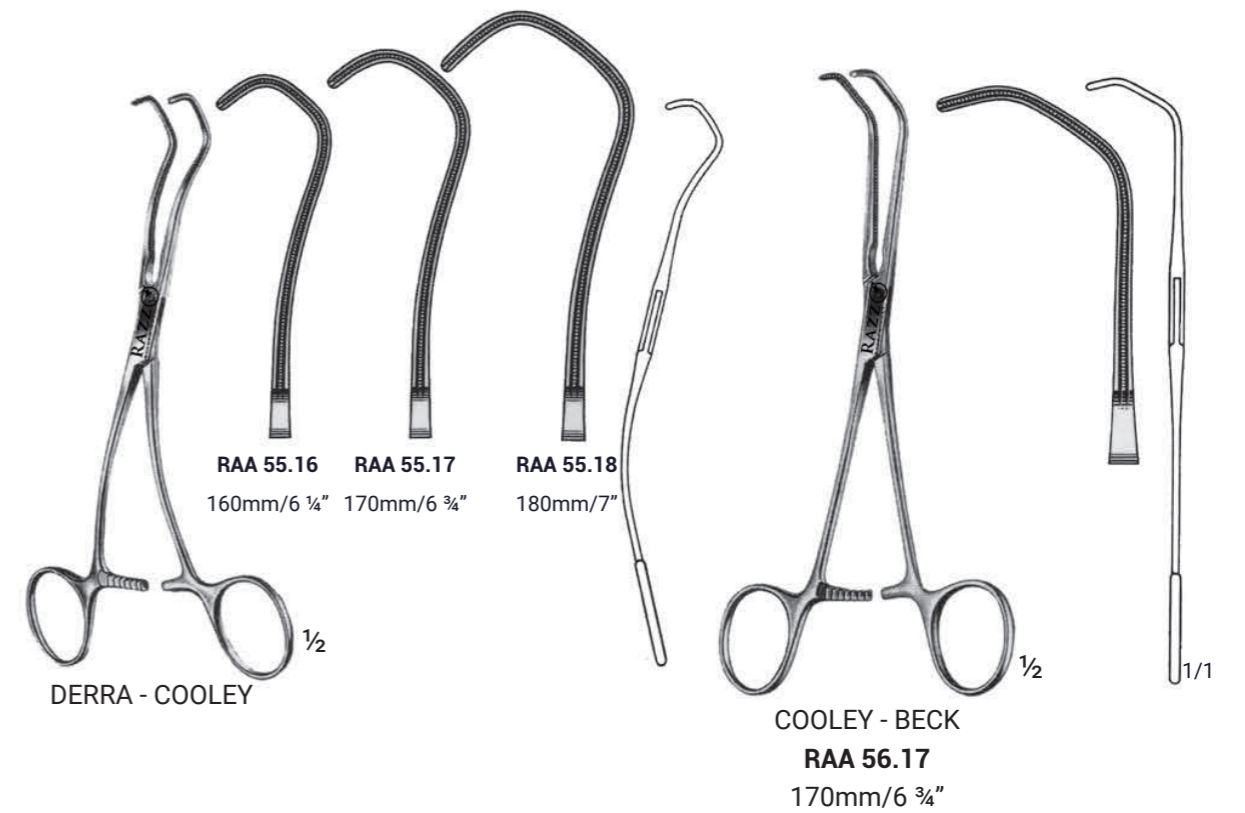
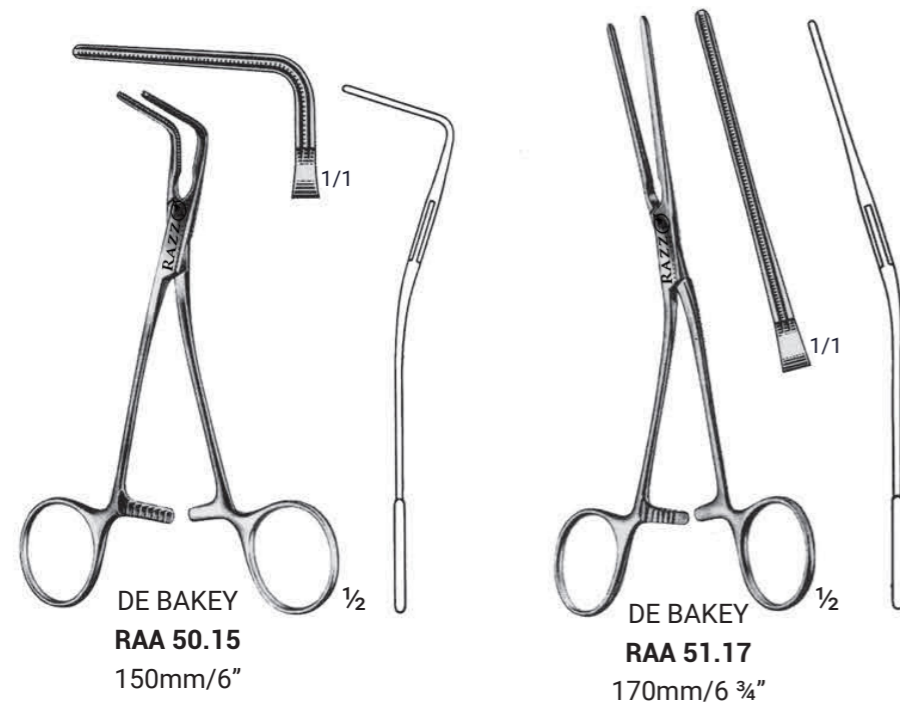
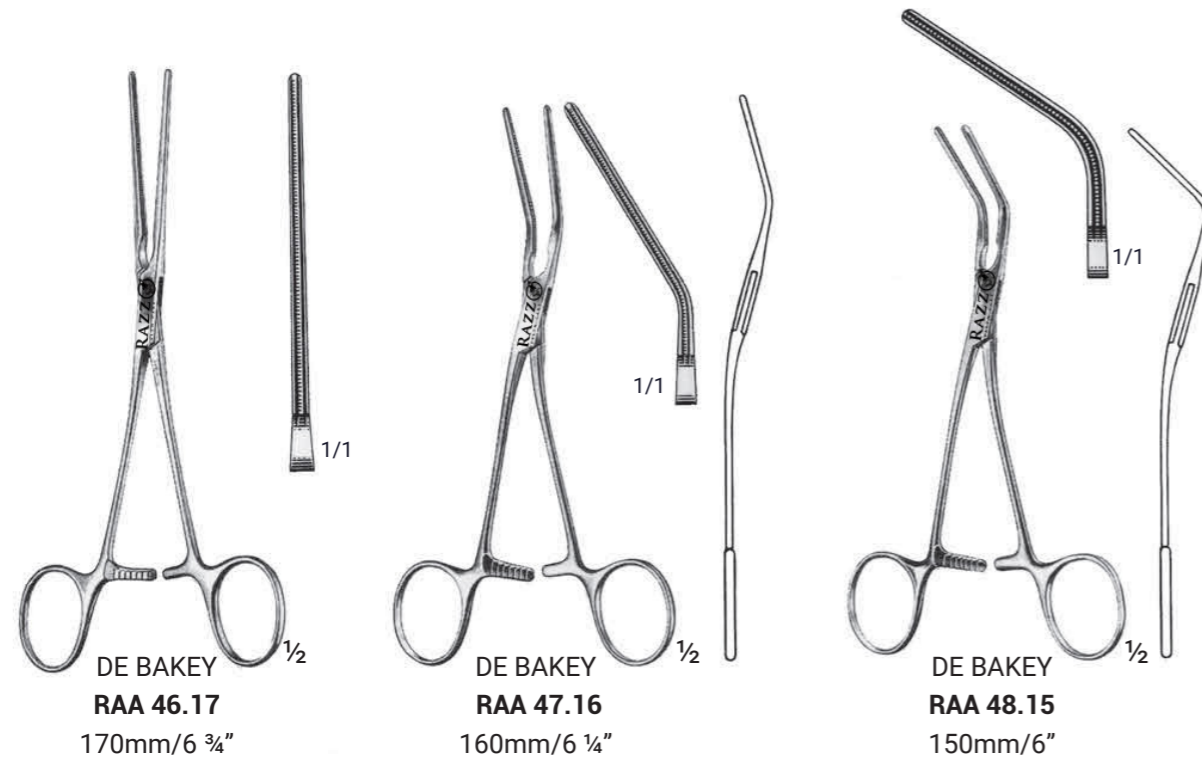

ANASTOMOSIS & MULTIPURPOSE CLAMPS PEDIATRIC PATTERNS

COOLEY ANASTOMOSIS CLAMPS PEDIATRIC



RAA 25.26

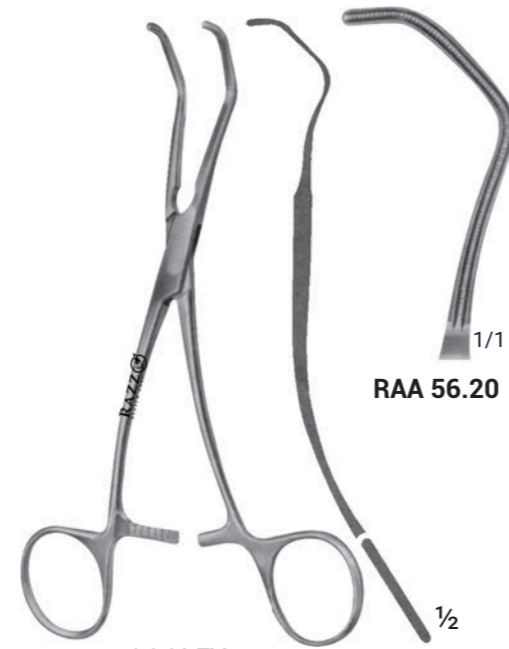

RAA 56.20

COOLEY
PEAD. ANASTOMOSIS &
MULTI PURPOSE CLAMPS
160mm/6 1/4"



16mm
71mm
170mm/6 3/4"
RAA 56.60

21mm
76mm
175mm/7"
RAA 56.61

27mm
80mm
175mm/7"
RAA 56.62

DERRA - COOLEY
ANASTOMOSIS CLAMP



DEBAKEY
260mm/10 1/4"



RAA 56.21

COOLEY
PEAD. ANASTOMOSIS &
MULTI PURPOSE CLAMPS
200mm/8"

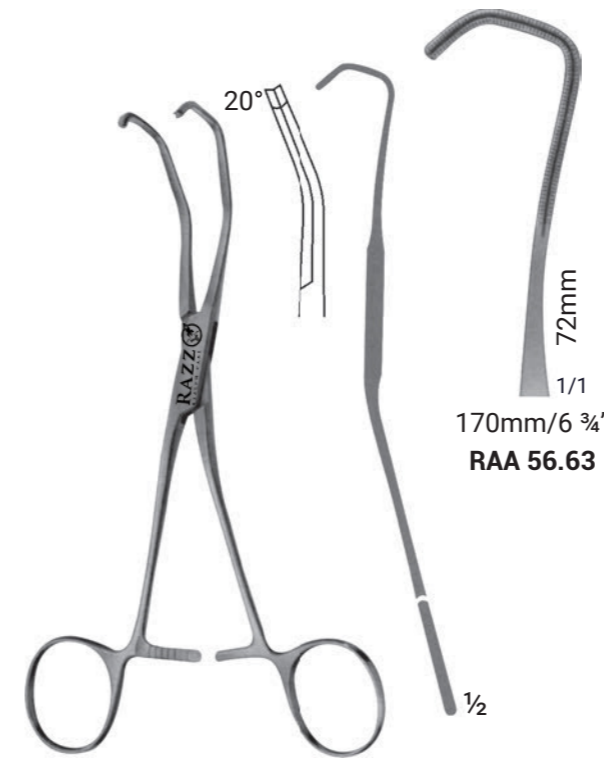

20°
72mm
170mm/6 3/4"
RAA 56.63

COOLEY
ANASTOMOSIS CLAMP

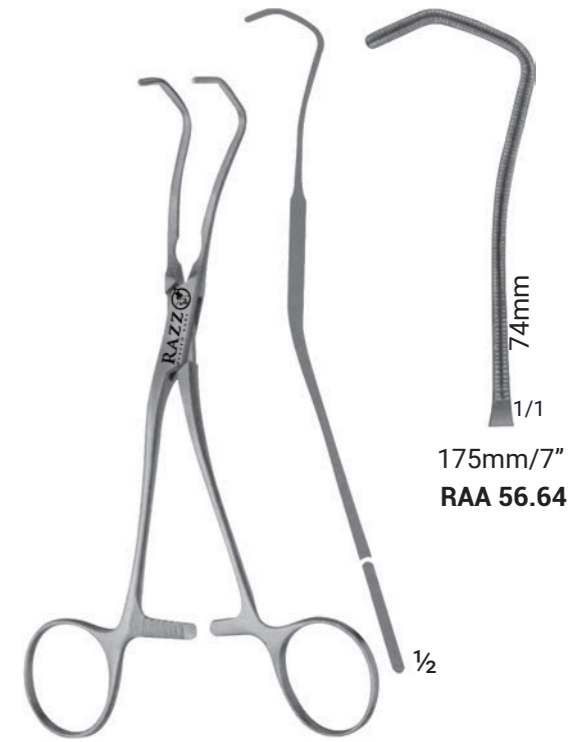

74mm
175mm/7"
RAA 56.64

TUBBS MITRAL VALVE DIALATOR

VALVE HOOKS

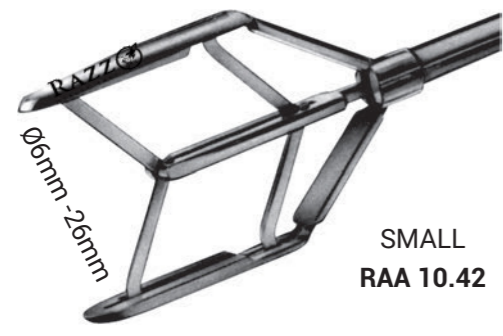

SMALL
RAA 10.42

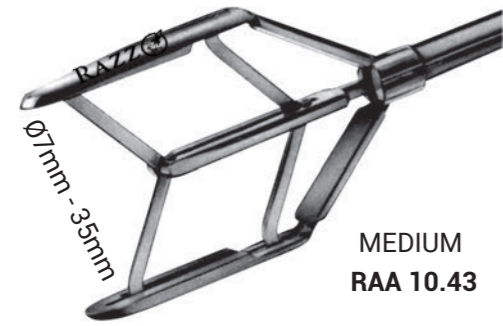

MEDIUM
RAA 10.43



LARGE
RAA 10.44



TUBBS MITRAL
VALVE DIALATOR



MITRVAL VALVE HOOK
300mm/12"
RAA 10.60 - SHARP
RAA 10.61 - BLUNT



MITRVAL VALVE HOOK
370mm/19"
RAA 10.70 - SHARP
RAA 10.71 - BLUNT



MITRVAL VALVE HOOK
240mm/9 1/2"
RAA 10.80 - SHARP
RAA 10.81 - BLUNT

TOURNI QUETS

AORTIC VALVE RONGEUR

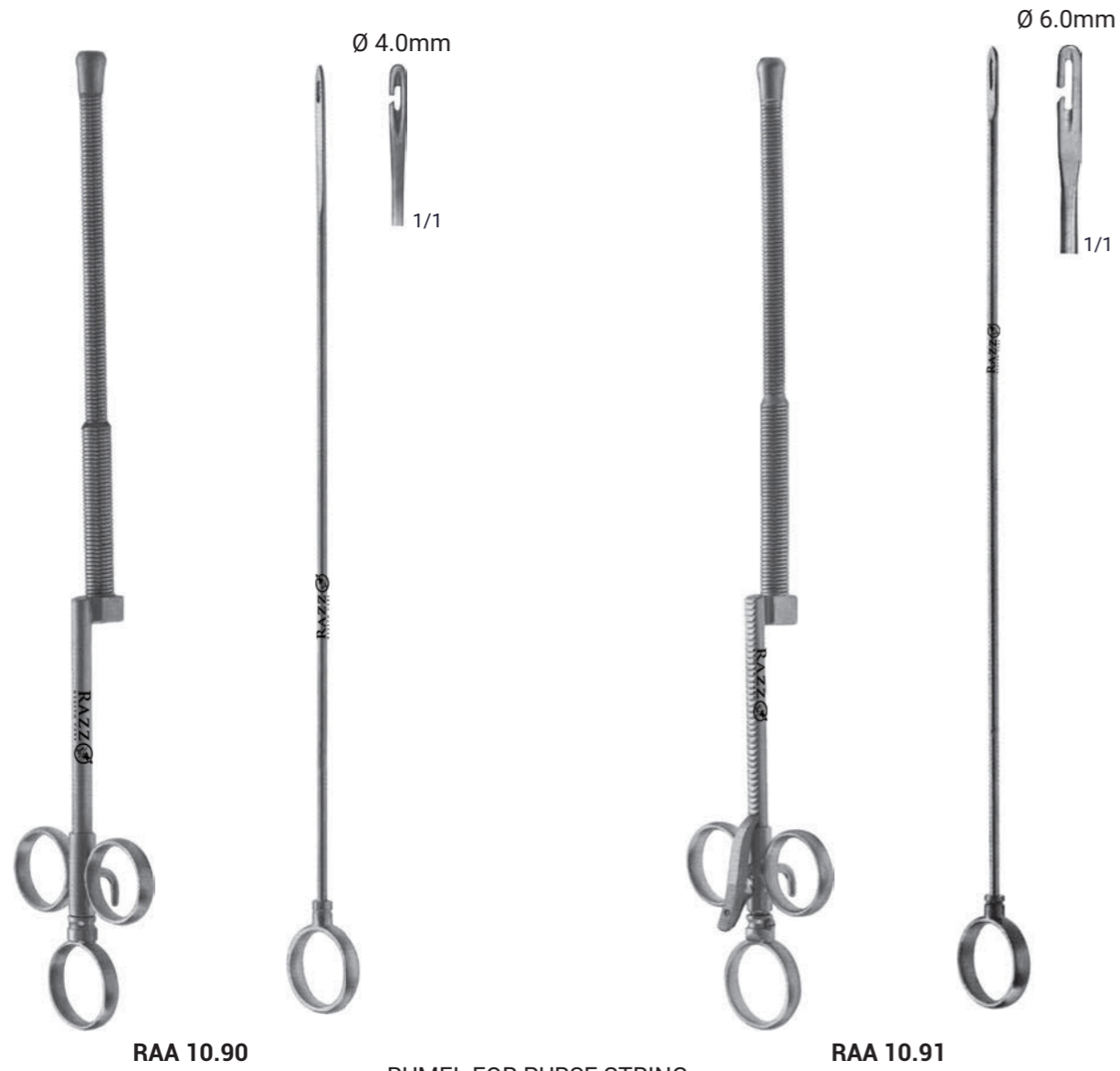

RUMEL FOR PURSE STRING SUTURE TENSION, WITH STILETTE
325mm/13"

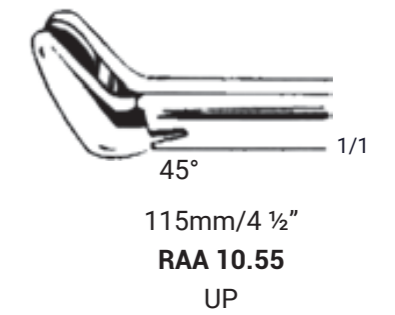
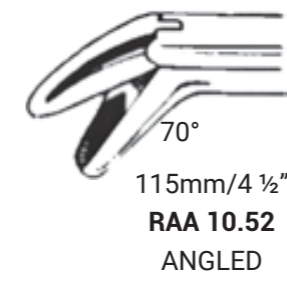
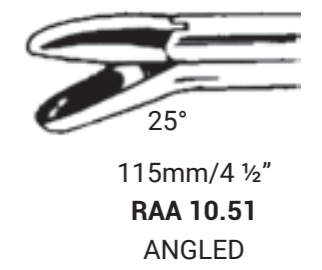
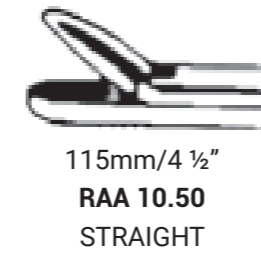
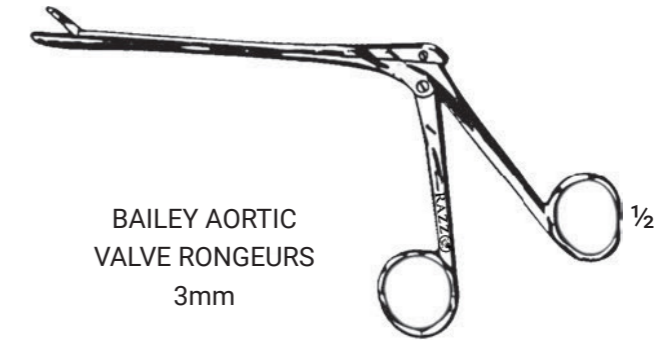

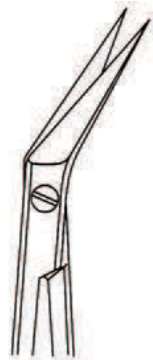

RAA 83.42
25°



RAA 83.92
25°

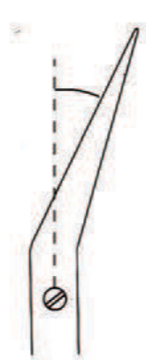

RAA 83.97
25°



RAA 87.32
185mm/7"
25°

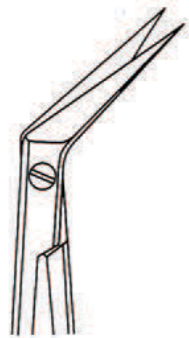

RAA 83.44
45°

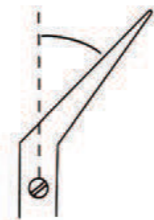

RAA 83.93
45°

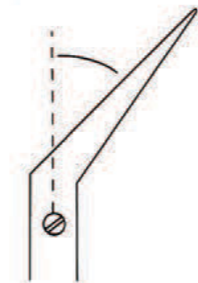

RAA 83.98
45°



RAA 87.34
180mm/7"
45°

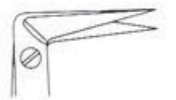

RAA 87.39
170mm/6 3/4"
90°



POTTS SMITH
190mm/7 1/2"

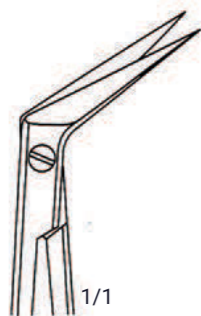

RAA 83.46
60°

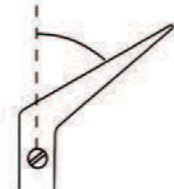

RAA 83.96
60°

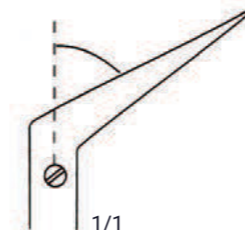

RAA 83.99
60°



RAA 85.41
125°



DIETRICH
180mm/7"



RAA 87.36
175mm/7"
60°



DIETRICH



RAA 87.40
170mm/6 3/4"
125°



POTTS SMITH, T/C
190mm/7 1/2"
RAA 83.97 - RAA 83.99
230mm/9"



ROSE
TUBE MILKING FORCEPS
CHILD
180mm/7"
RAI 35.50

ADULT
180mm/7"
RAI 35.51



RUBIN
TUBE ANCHORING FORCEPS
Ø 5mm
RAI 35.60 - 150mm/6"
Ø 13mm
RAI 35.61 - 150mm/6"



SEMB
RIB RASPATORIES

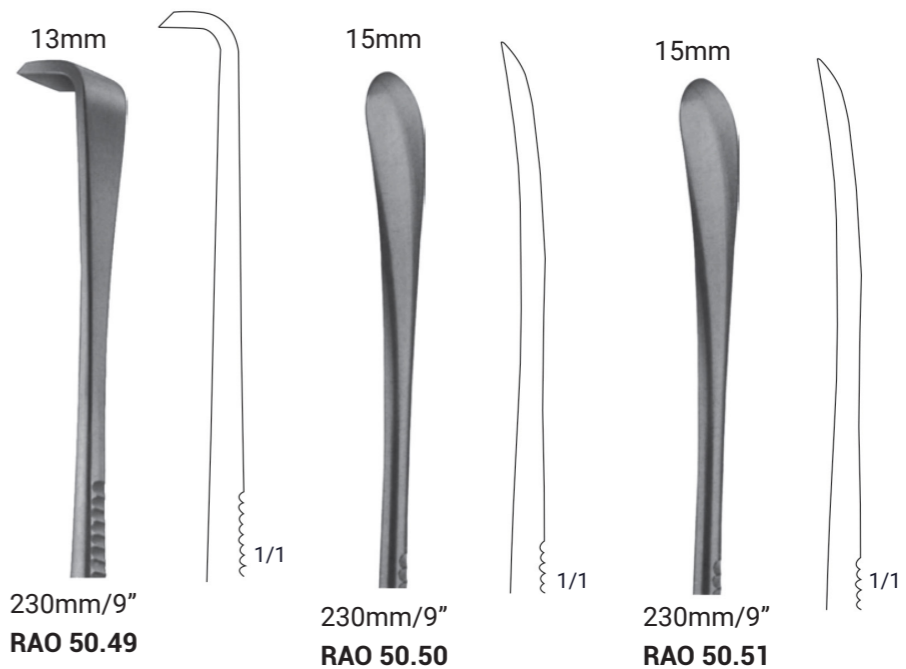

WIRE TWISTING FORCEPS

LEMMON INTIMA DISSECTORS



STERNUM
WIRE TWISTER
175mm/6 3/4"



STERNUM
WIRE TWISTER
150mm/6"



STERNUM WIRE
TWISTER WITH GUARD
170mm/6 3/4"



BAUMGARTNER
WIRE TWISTER
200mm/8"

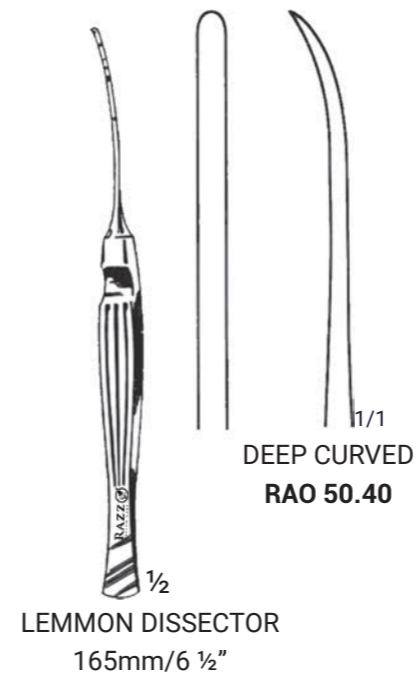

LEMMON DISSECTOR
165mm/6 1/2"

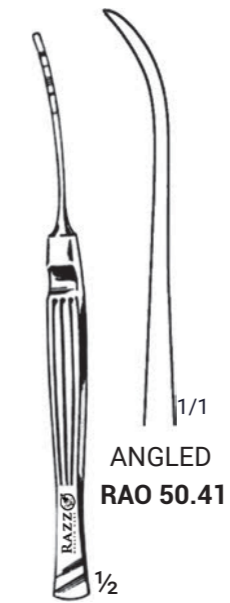

ANGLED
RAO 50.41

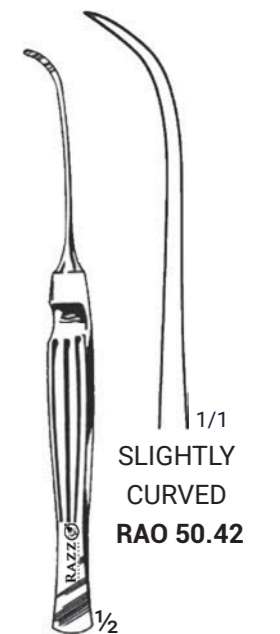

SLIGHTLY
CURVED
RAO 50.42

CARDIOTOMY SUCKER



CARDIOTOMY SUCKER
ADULT
300mm/12"
RAO 50.78



CARDIOTOMY SUCKER
CHILD
250mm/10"
RAO 50.79

WOUND AND VESSEL RETRACTORS



GIL-VERNET
240mm/9 1/2"

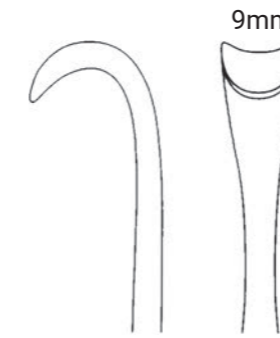

RAO 50.60

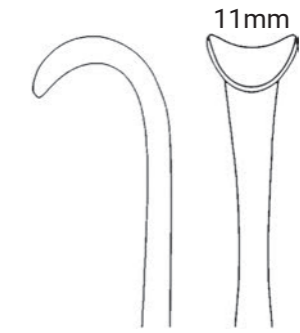

RAO 50.61

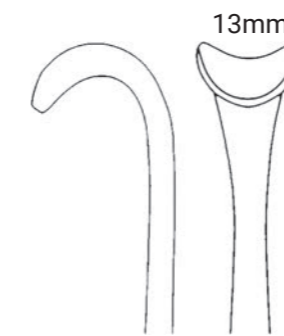

RAO 50.62

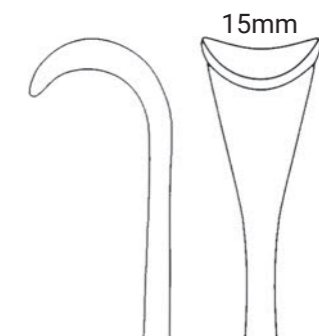

RAO 50.63

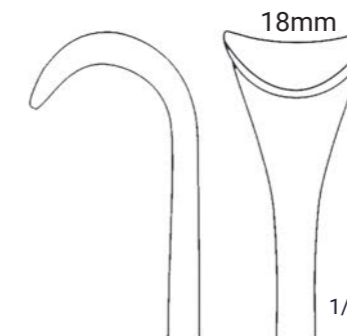

RAO 50.64

AORTA VALVE RETRACTORS

ATRIAL RETRACTORS

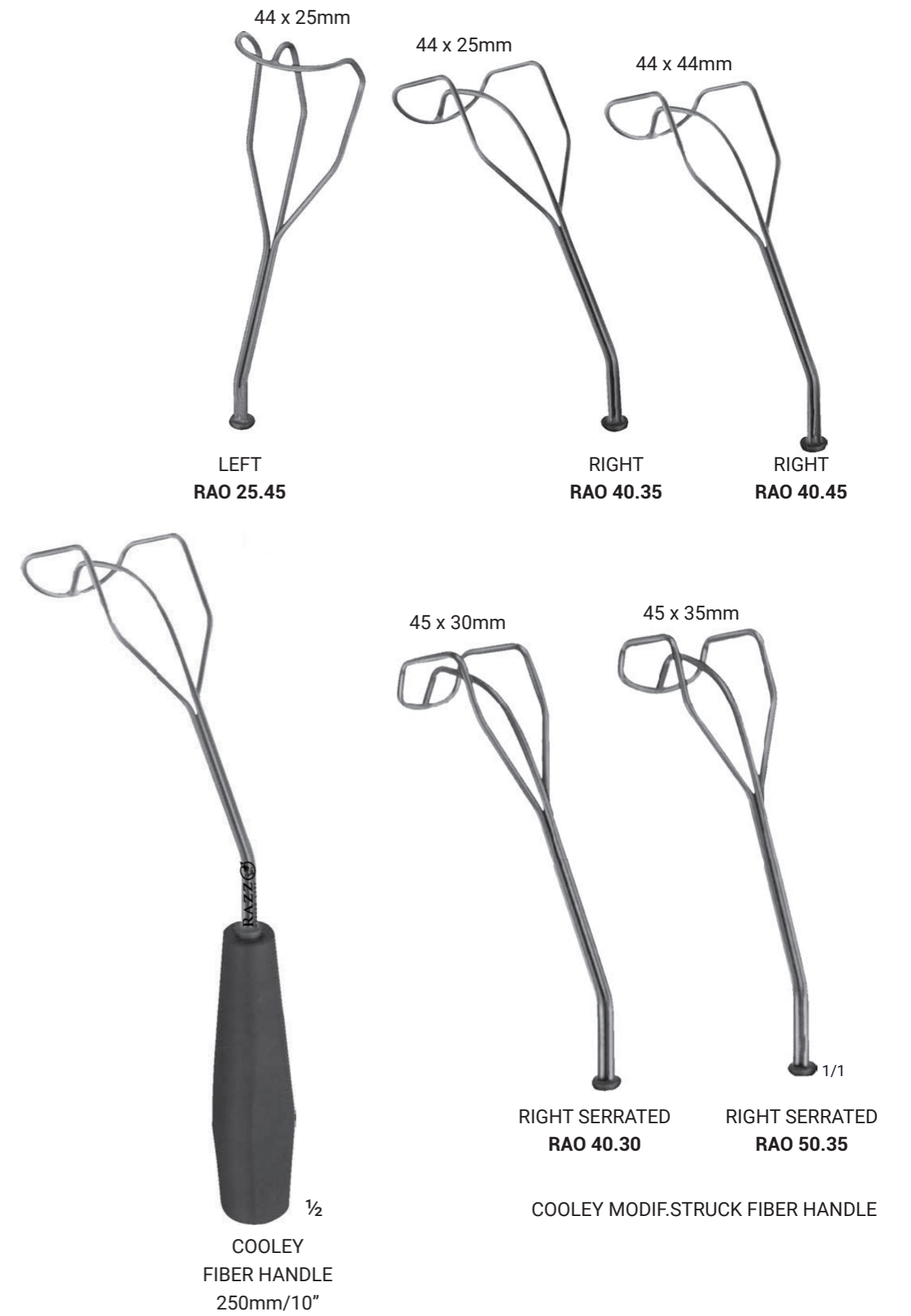

RETRACTORS

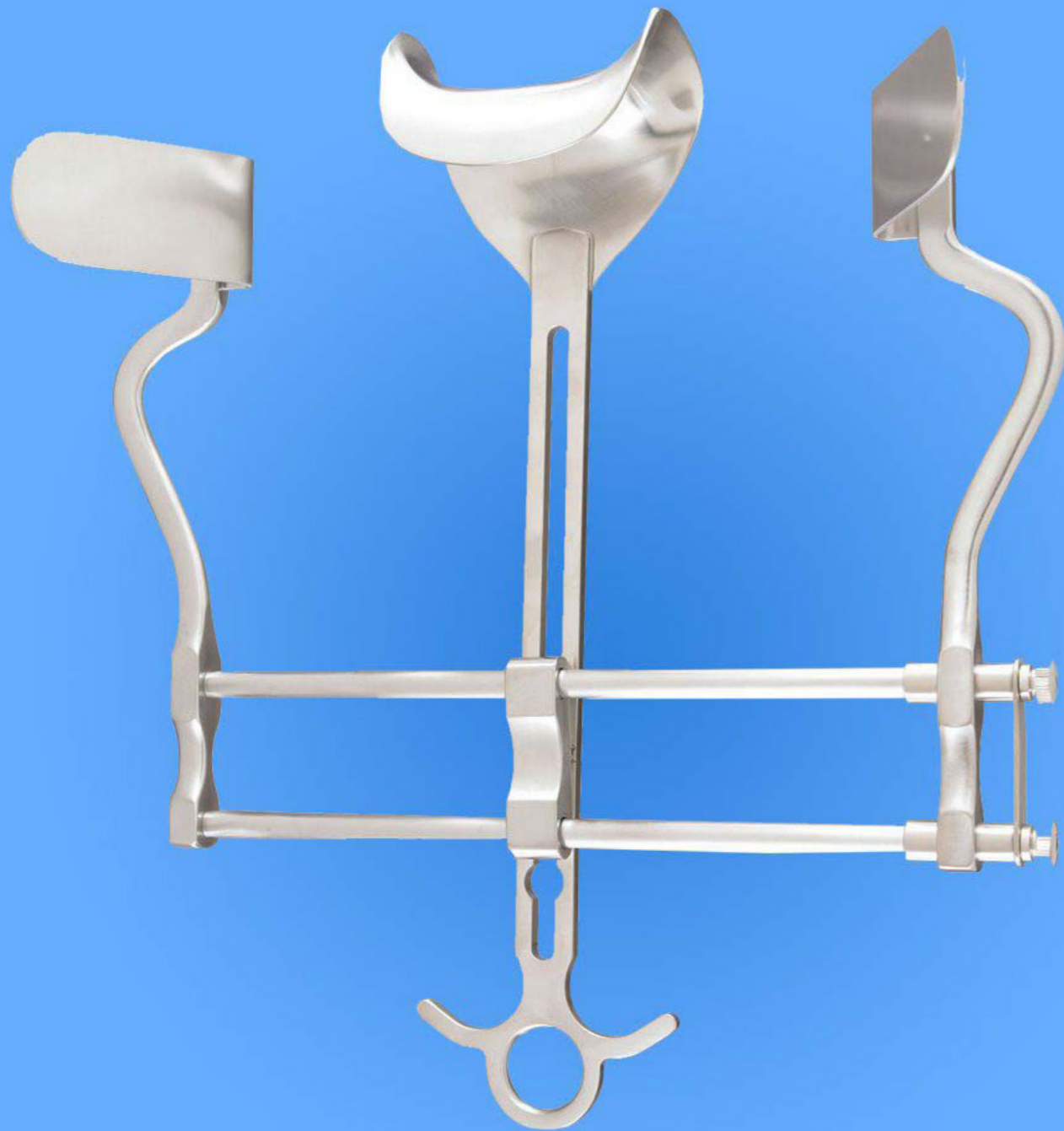

BONE AND RIB SHEARS, STERNUM CUTTERS



RAO 07.01
For the Right Hand
RAO 07.02
For the Left Hand



EPICARDIAC RETRACTOR

RIB SPREADERS



1/1
RAO 03.23



1/1
RAO 03.24



HAIGHT	A	B	C
RAO 23.20	30mm	30mm	90mm/3 1/2"

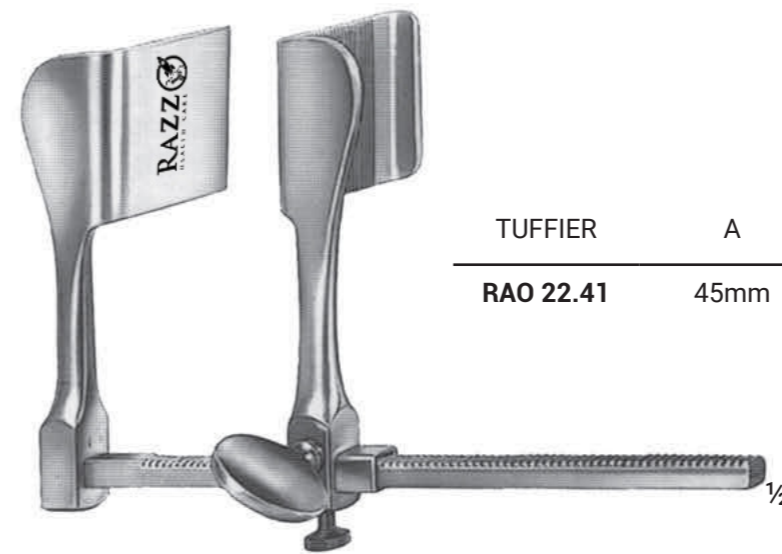
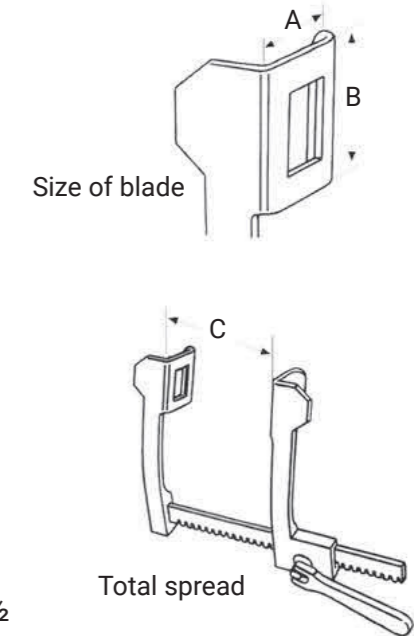

TUFFIER	A	B	C
RAO 22.41	45mm	45mm	160mm/6 1/4"

RIB SPREADERS

RIB SPREADERS



FINOCHIETTO - BABY

	A	B	C
RAO 21.61	15mm	15mm	75mm/3"

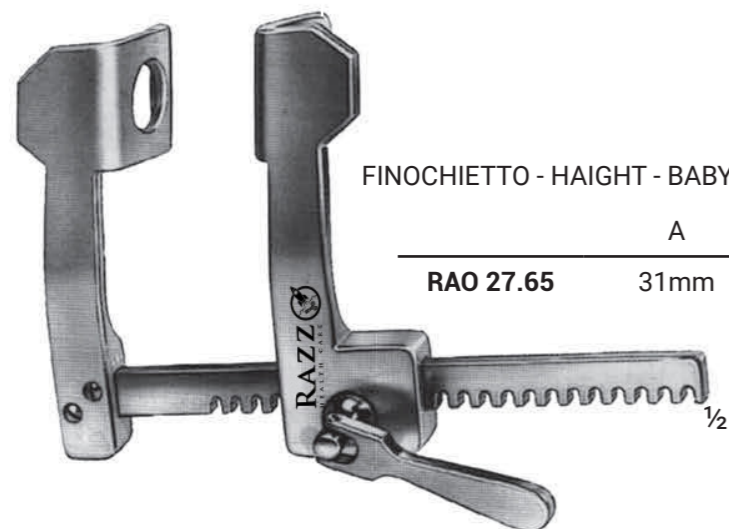
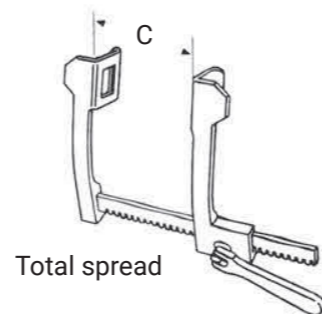
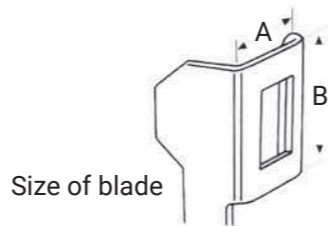

FINOCHIETTO - HAIGHT - BABY

	A	B	C
RAO 27.65	31mm	31mm	100mm/4"

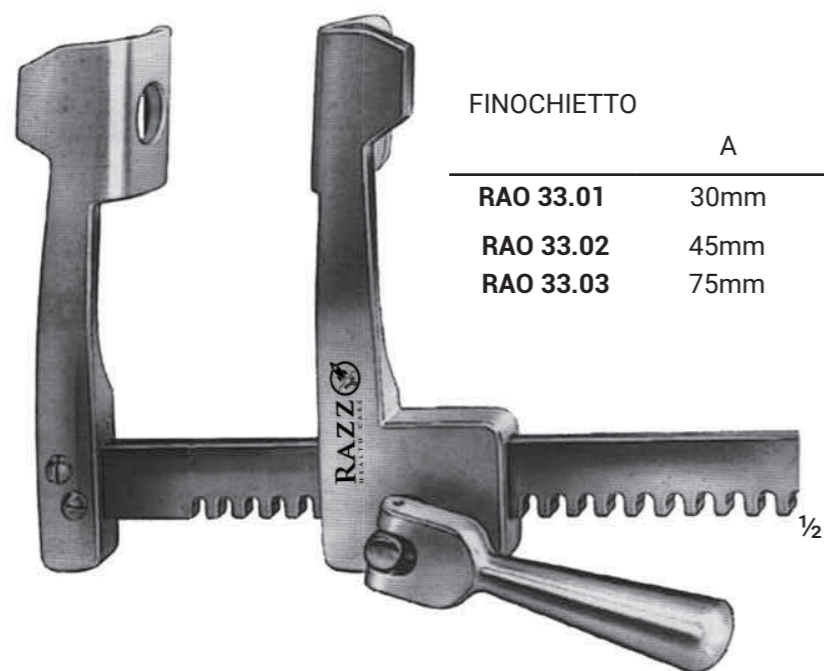

FINOCHIETTO

	A	B	C
RAO 33.01	30mm	40mm	150mm/6"
RAO 33.02	45mm	65mm	200mm/8"
RAO 33.03	75mm	65mm	250mm/10"

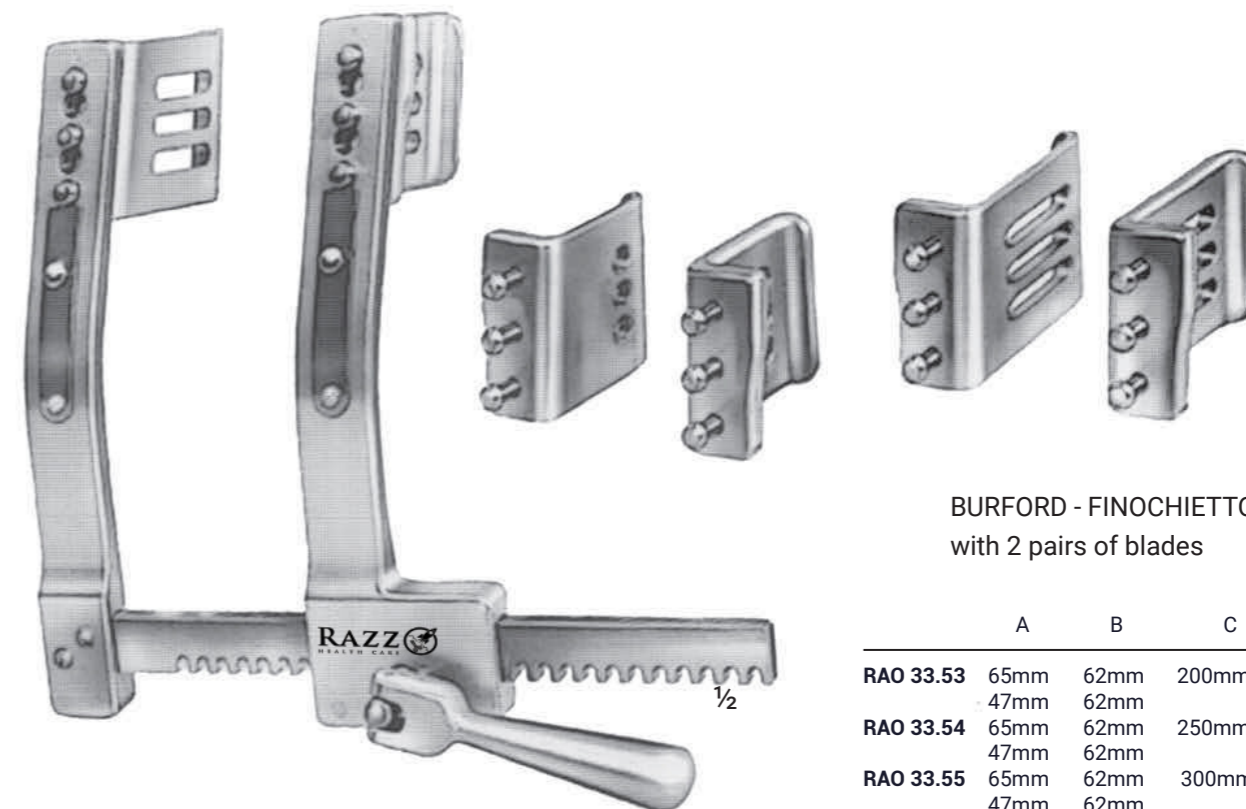

BURFORD - FINOCHIETTO with 2 pairs of blades

	A	B	C
RAO 33.53	65mm 47mm	62mm	200mm/8"
RAO 33.54	65mm 47mm	62mm	250mm/10"
RAO 33.55	65mm 47mm	62mm	300mm/12"

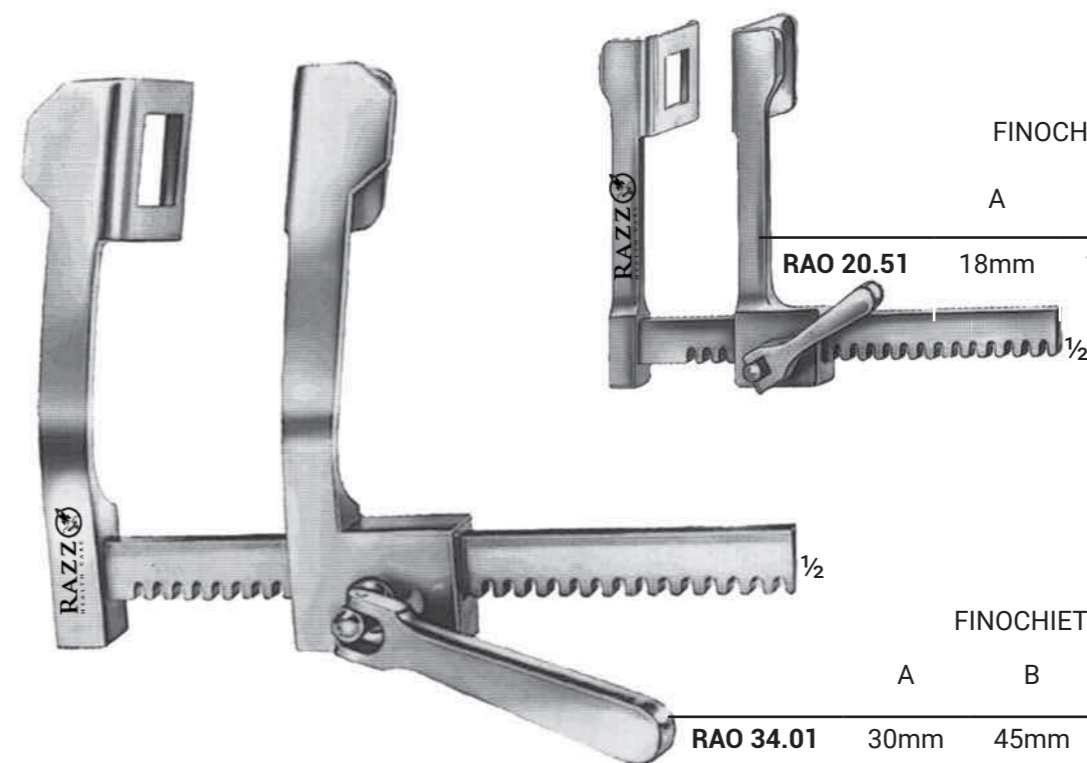

FINOCHIETTO - BABY

	A	B	C
RAO 20.51	18mm	15mm	90mm/3 1/2"

FINOCHIETTO

	A	B	C
RAO 34.01	30mm	45mm	150mm/6"
RAO 34.02	46mm	62mm	190mm/7 1/2"
RAO 34.03	80mm	65mm	190mm/7 1/2"

STERNUM SPEADERS

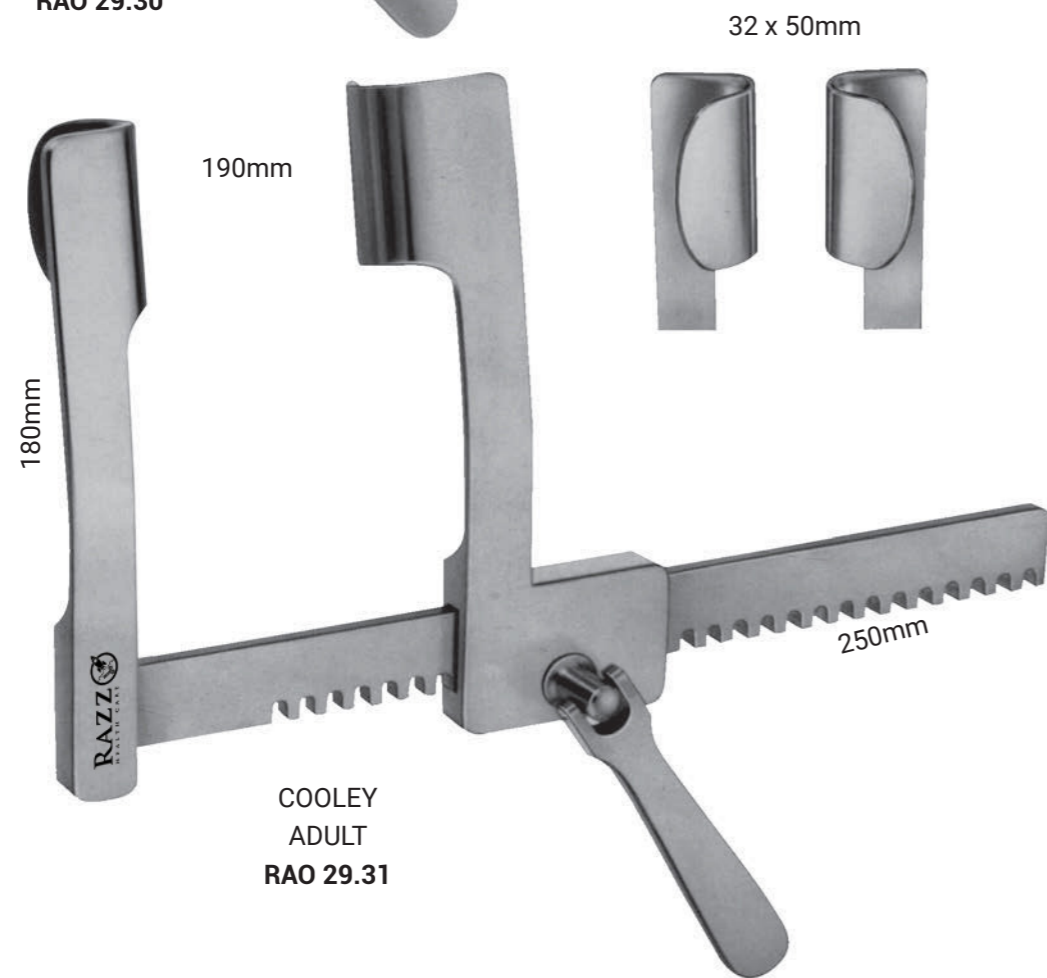
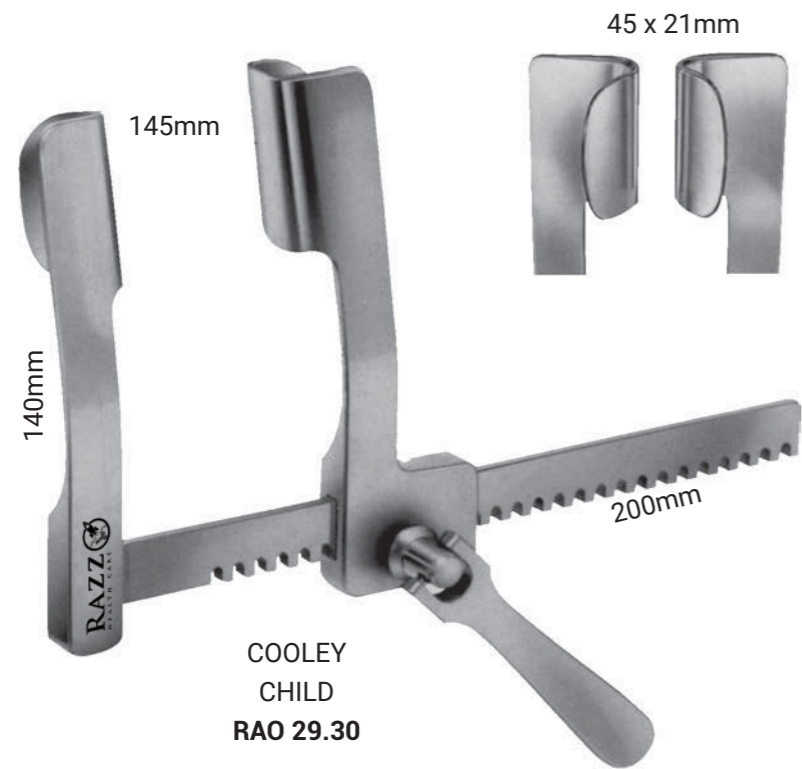

STERNUM RIB SPREADERS



I.M.A RETRACTOR

I.M.A RETRACTOR

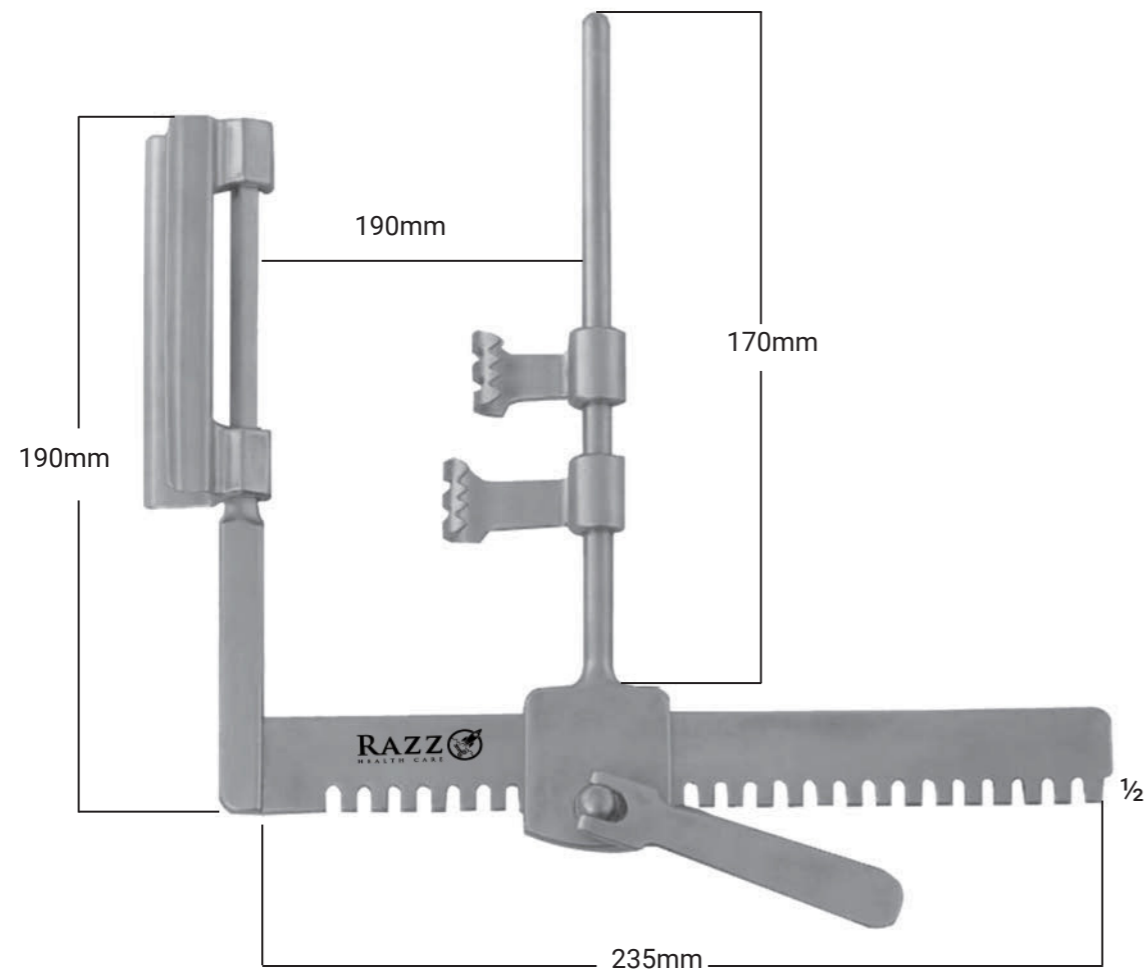

I.M.A RETRACTOR

With One Sternal Blade & Two Adjustable for Preparation of Aa Mammariae Internae

Arm Length 190mm

Center Arm Length 170mm S

pread 190mm

Rock Length 235mm

RAO 07.30



ROSE MALLEABLE
RETRACTOR
RAO 07.35



MARBERGER
RETRACTOR
20mm,Medium
RAO 07.36



COOLEY ATRIAL MALLEABLE
RETRACTOR 35mm,
Medium **RAO 07.37**



COOLEY ATRIAL RIGID
RETRACTOR
35mm,Medium
RAO 07.38

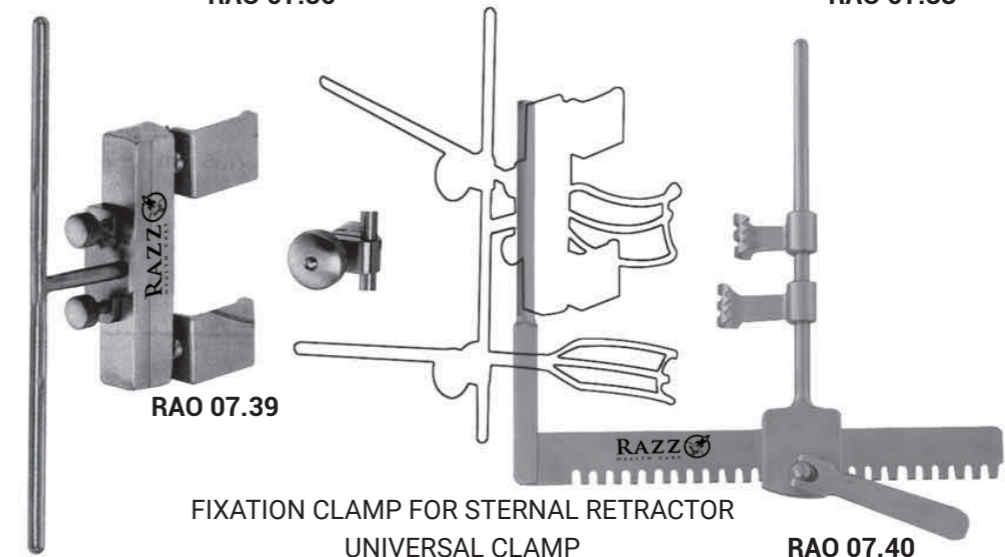

RAO 07.39

FIXATION CLAMP FOR STERNAL RETRACTOR
UNIVERSAL CLAMP

RAO 07.40

RIB CONTRACTORS, RASPATORIES & LUNG SPATULA

LUNG GRASPING FORCEPS



BAILEY
RAO 36.40
160mm/6 1/4"



BAILEY - GIBBON
RAO 37.50
160mm/6 1/4"



DOYEN
RAO 45.01 - RAO 46.12
180mm/7"



RAO 45.01



RAO 45.02



RAO 46.11

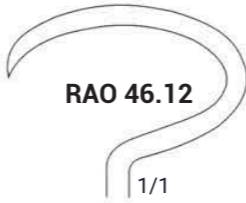

RAO 46.12

1/1



ALLISON
RAO 50.05
270mm/10 1/4"

RAO 50.10
320mm/12 1/2"

50 x 75mm



DAVIDSON
RAO 51.50

90 x 75mm



DAVIDSON
RAO 52.90



LOVELACE
190mm/7 1/2"

1/2



RAO 56.19

1/1

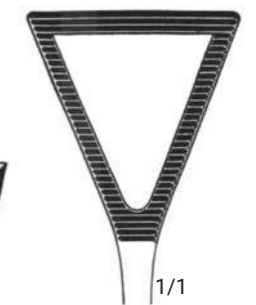

RAO 56.39

1/1



LOVELACE
190mm/7 1/2"

1/2

TISSUE AND ORGAN HOLDING FORCEPS

BRONCHUS FORCEPS

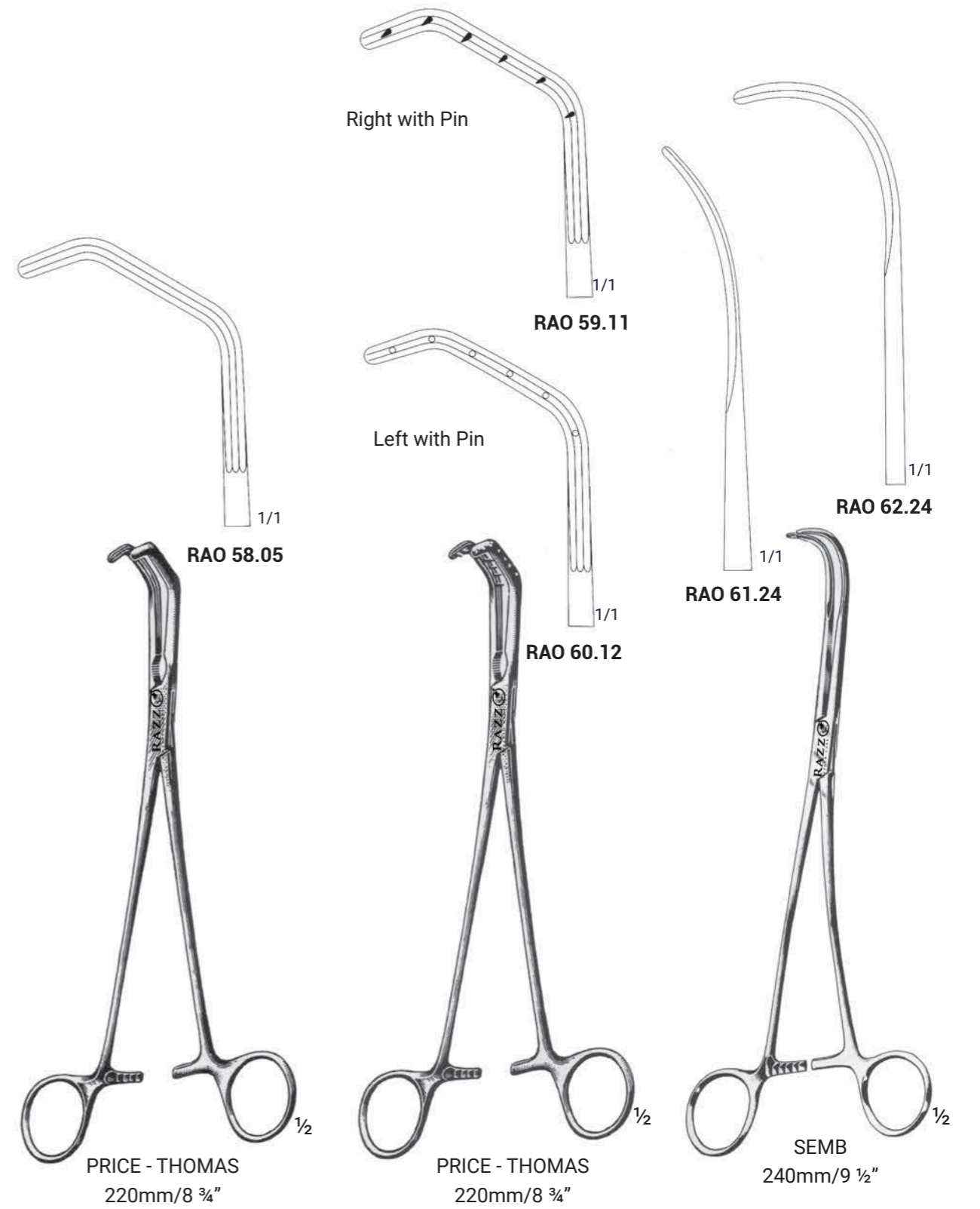
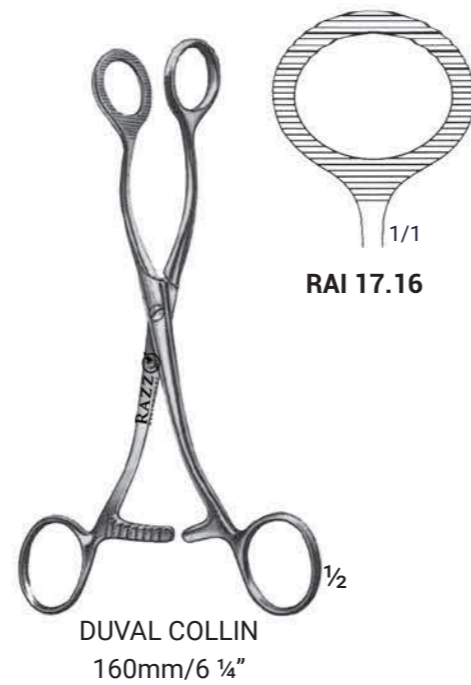
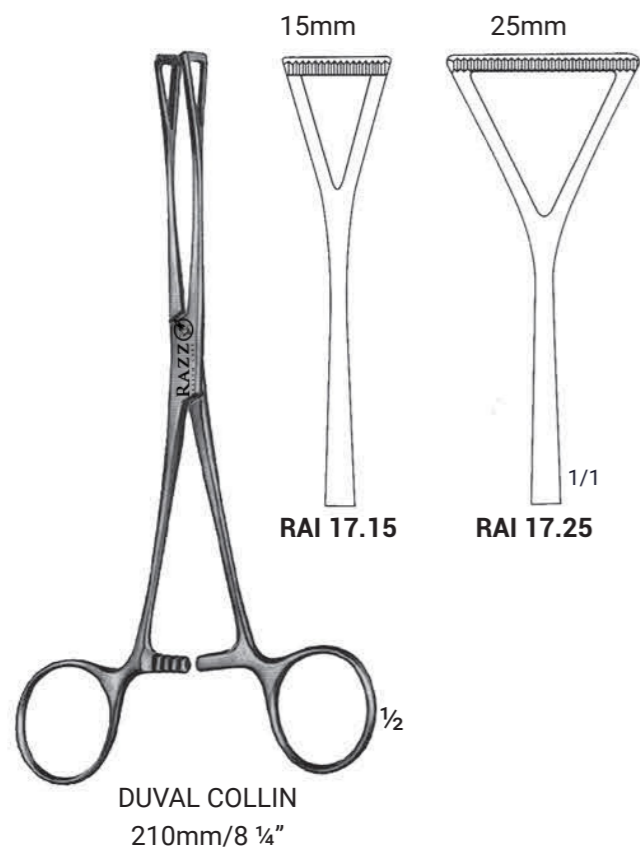

TISSUE GRASPING FORCEPS

RETRACTORS



TUTTLE (SINGLEY)
RAE 58.18 -180mm/7"
RAE 58.23 -230mm/9"

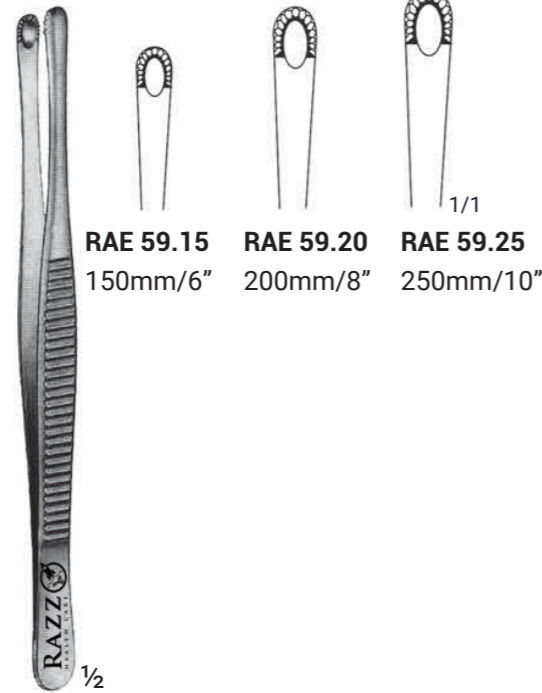

RUSSIAN PATTERN

RAE 59.15 150mm/6"
RAE 59.20 200mm/8"
RAE 59.25 250mm/10"



NELSON

RAE 60.15 -150mm/6"
RAE 60.23 -230mm/9"



COLLIN DUVAL
200mm/8"

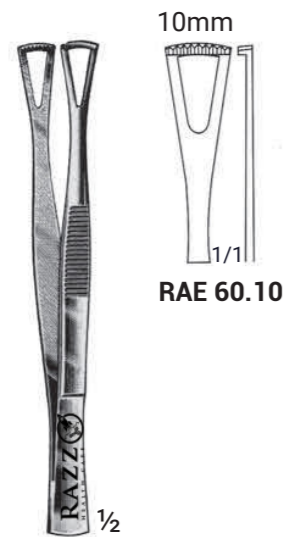

DUVAL
145mm/5 3/4"

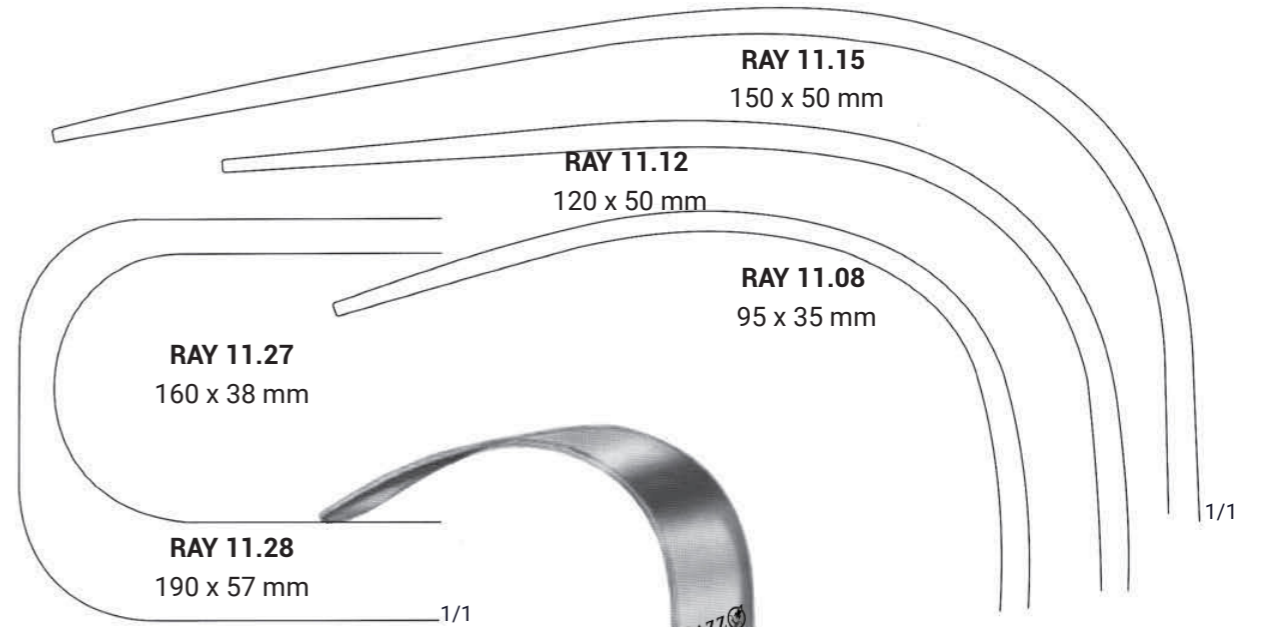

MIKULICZ
RAY 11 .25
260mm/10 1/4"

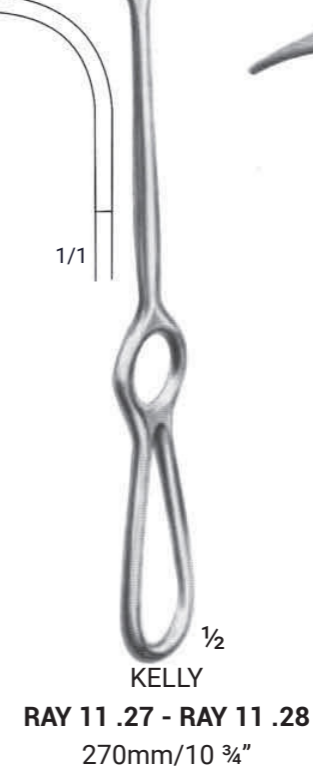

KELLY
RAY 11 .27 - RAY 11 .28
270mm/10 3/4"



MIKULICZ
RAY 11 .08 - RAY 11.15
260mm/10 1/4"

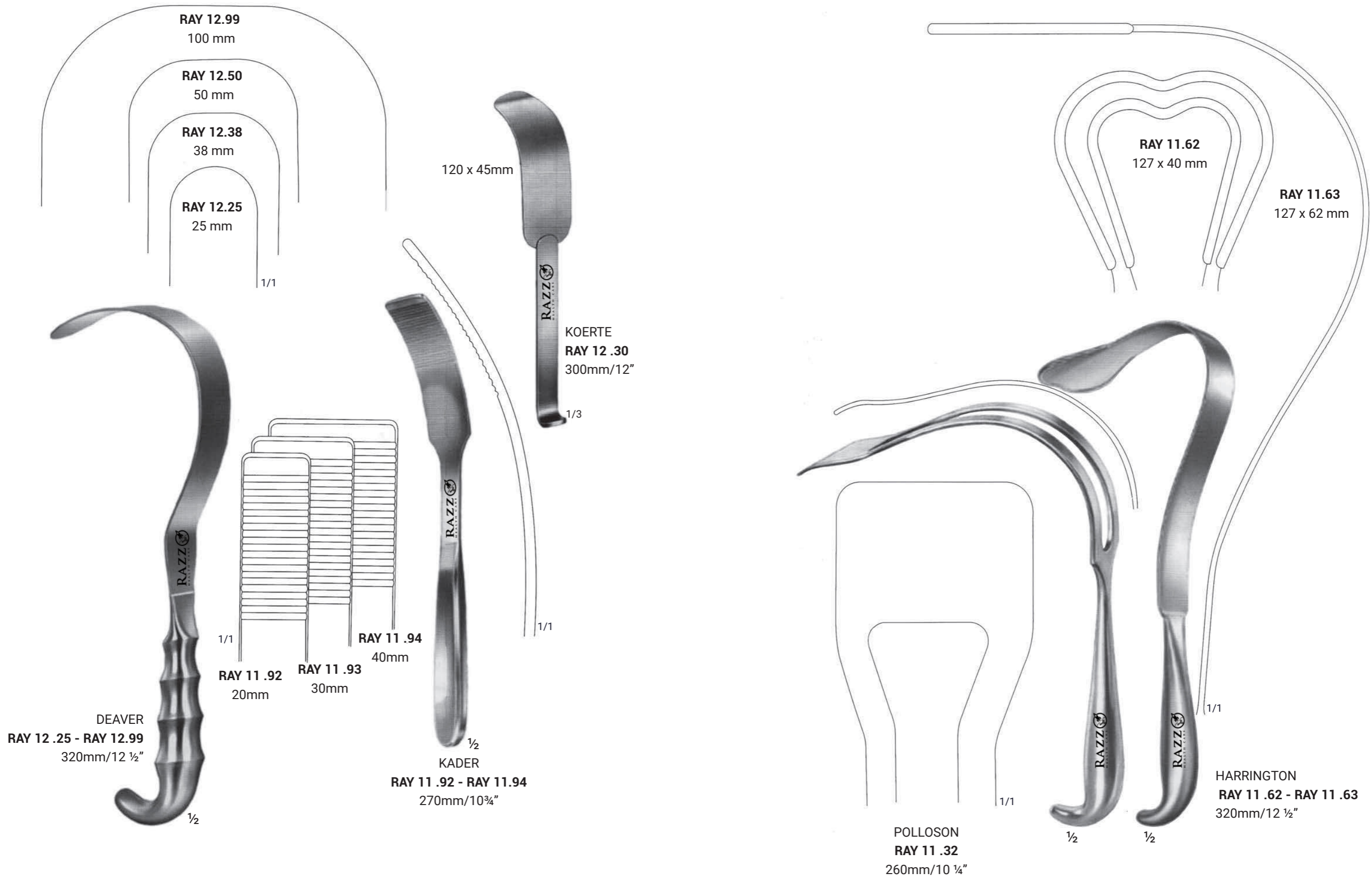

RETRACTORS

VASCULAR DILATORS



ZENKER

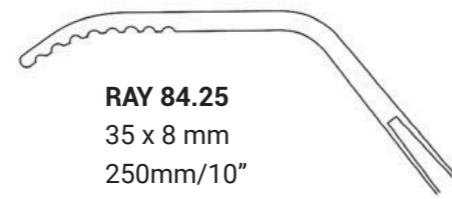

RAY 84.25
35 x 8 mm
250mm/10"

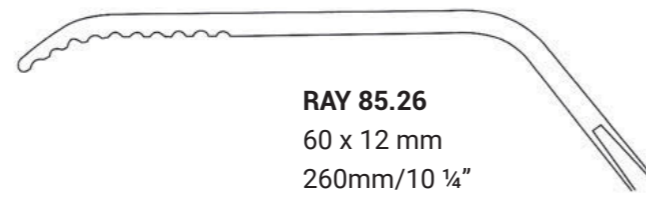

RAY 85.26
60 x 12 mm
260mm/10 1/4"

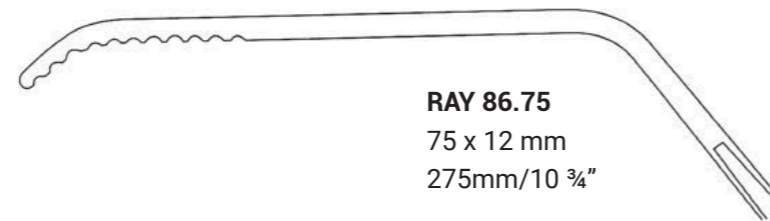

RAY 86.75
75 x 12 mm
275mm/10 3/4"

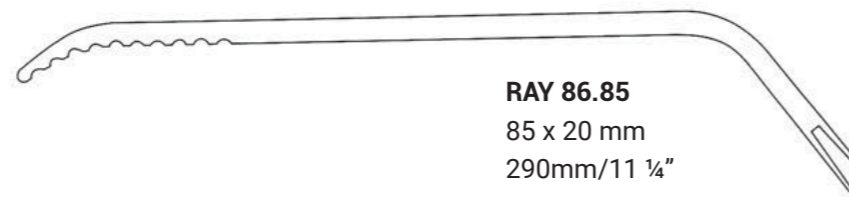

RAY 86.85
85 x 20 mm
290mm/11 1/4"

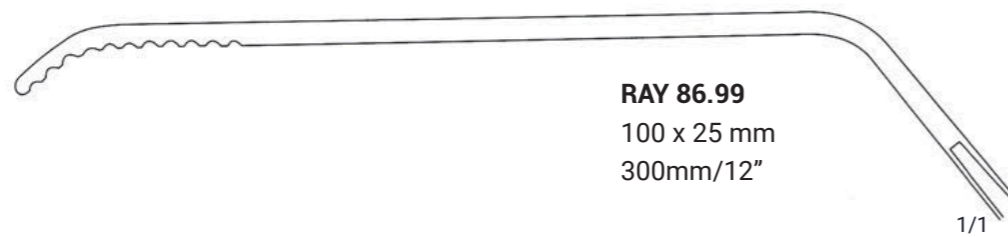

RAY 86.99
100 x 25 mm
300mm/12"

1/1

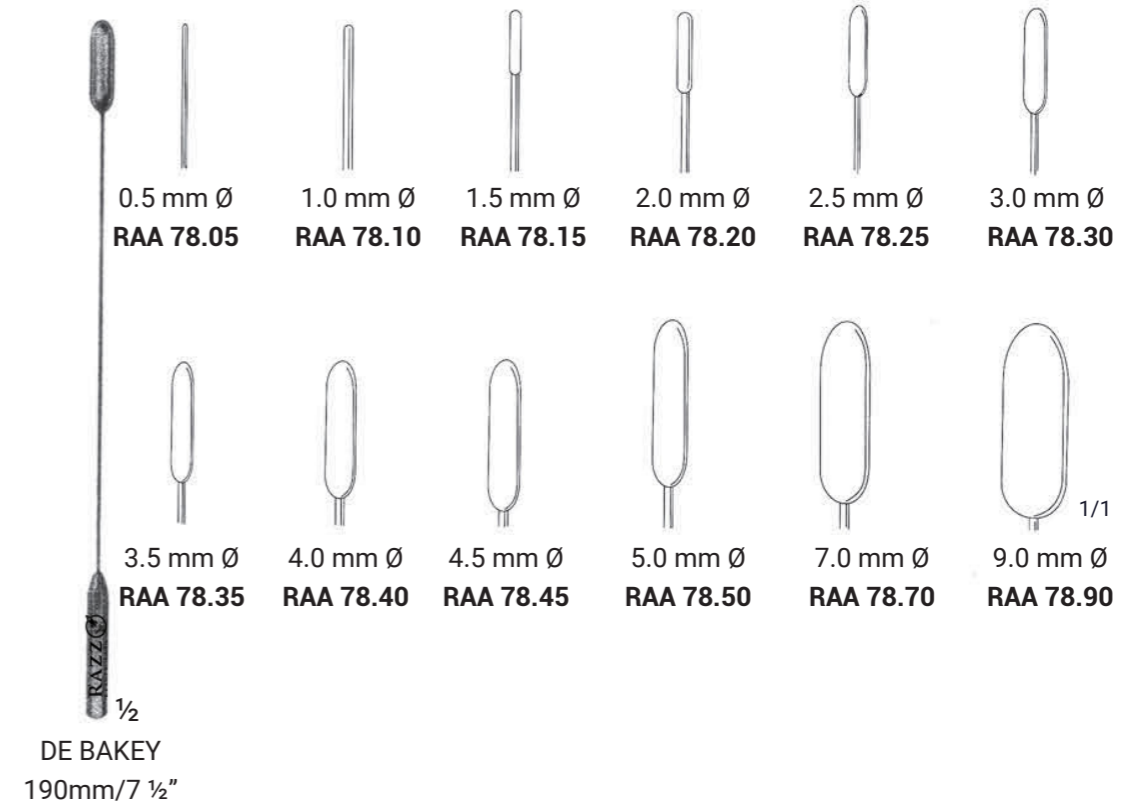

GARRET
140mm/5 1/2"
RAA 79.19
Set of 9 pieces from

- Ø 1,0mm
- Ø 1,5mm
- Ø 2,0mm
- Ø 2,5mm
- Ø 3,0mm
- Ø 3,5mm
- Ø 4,0mm
- Ø 4,5mm
- Ø 5,0mm



GARRETT
210mm/8 1/4"
RAA 79.20
Set of 9 pieces from

- Ø 1,0mm
- Ø 1,5mm
- Ø 2,0mm
- Ø 2,5mm
- Ø 3,0mm
- Ø 3,5mm
- Ø 4,0mm
- Ø 4,5mm
- Ø 5,0mm

CARDIO THORACIC

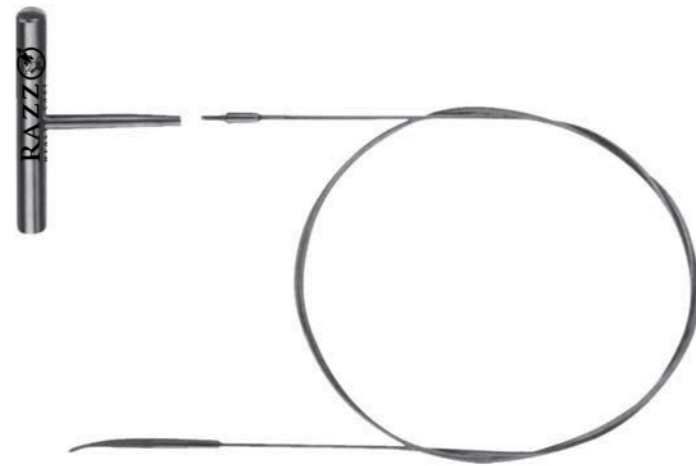
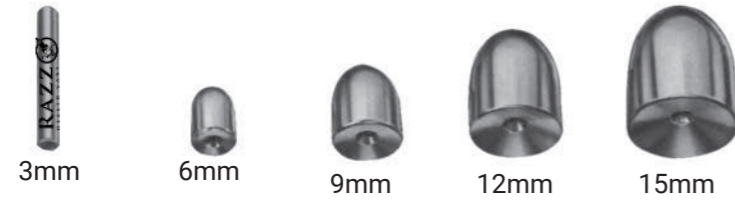

NABATOFF
Vein Strippers
RBA 07.92



ORTHOPEDIC INSTRUMENTS

BONE AWL

PERIOSTEAL ELEVATORS



ESMARCH
BONE AWL - FIBER HANDLE
WITH 2 DRILL POINT
200mm/8"
RVA 65.01



BONE AWL
WITH EYE - FIBER HANDLE
170mm/6 1/2"
RVA 65.02



BONE AWL
WITHOUT EYE - FIBER HANDLE
150mm/6"
RVA 65.03



ADSON PERIOSTEAL
ELEVATORS, SHARP
165mm/6 1/4"
RTA 28.30

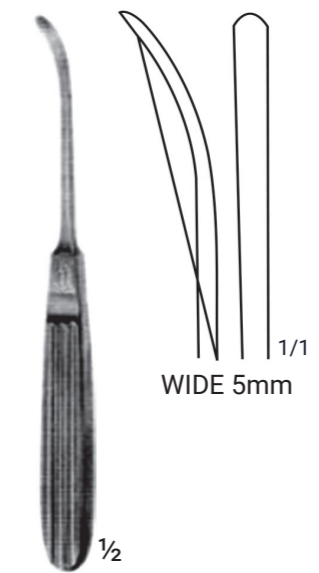

LANDOLT PERIOSTEAL
ELEVATORS, SEMI-SHARP
175mm/6 3/4"
RTA 28.32

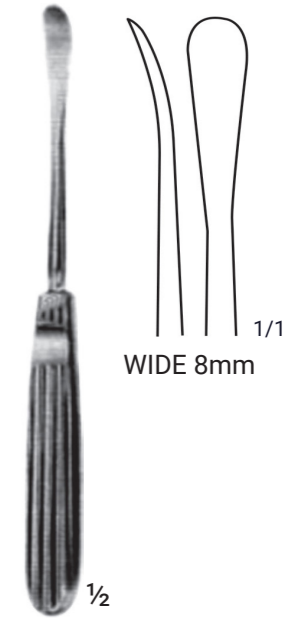

COTTLE PERIOSTEAL
ELEVATORS, SEMI-SHARP
195mm/7 3/4"
RTA 28.34

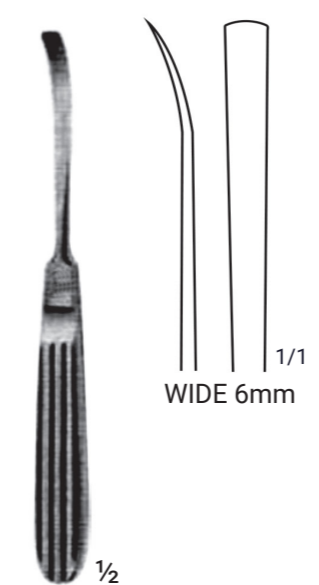

CASPER PERIOSTEAL
ELEVATORS, SEMI-SHARP
180mm/7"
RTA 28.36

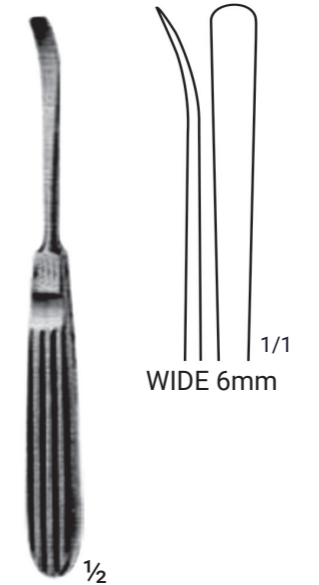

CASPER PERIOSTEAL
ELEVATORS, SEMI-SHARP
180mm/7"
RTA 28.40

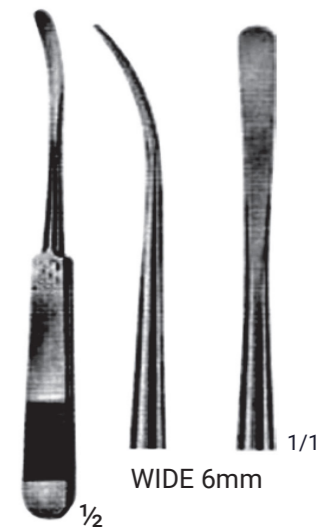

ADSON PERIOSTEAL
ELEVATORS
165mm/6 1/4"
RTA 28.42

PERIOSTEAL RASPATORIES

PERIOSTEAL RASPATORIES & BONE LEVERS

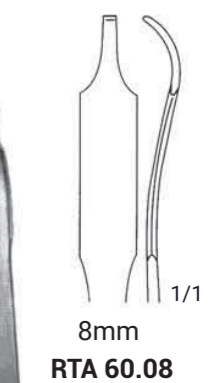
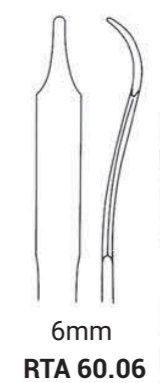
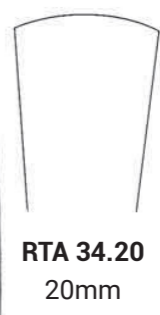
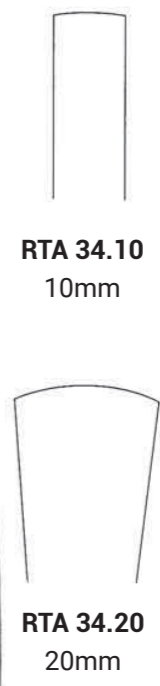
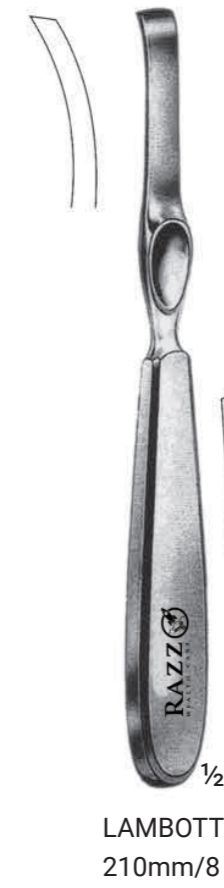
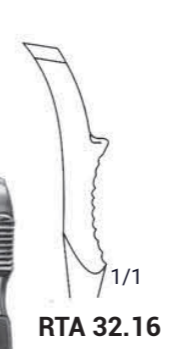
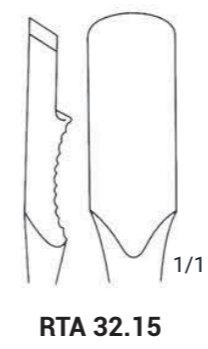

PERIOSTEAL ELEVATORS & RASPATORIES

PERIOSTEAL RASPATORIES, DISSECTORS & ELEVATORS

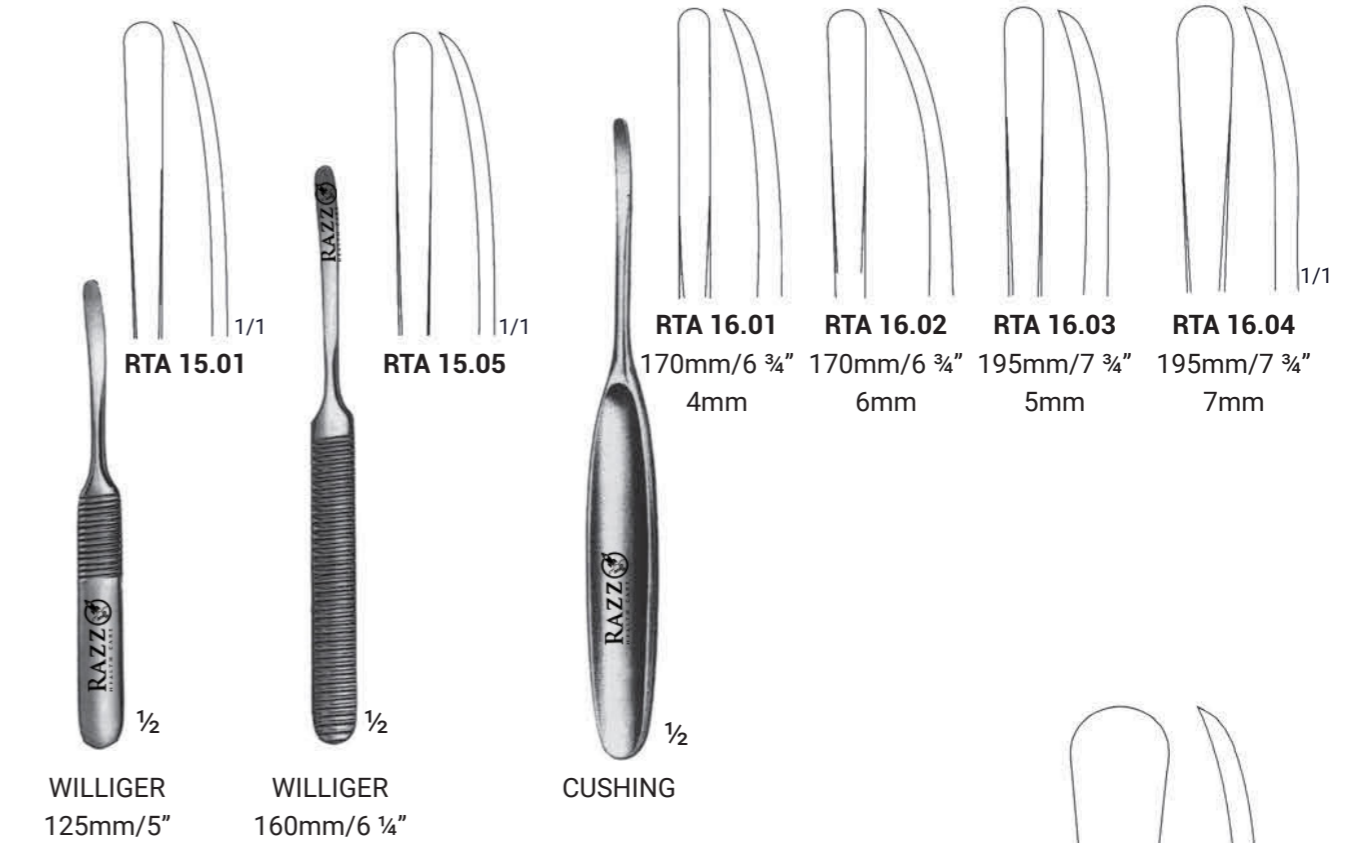
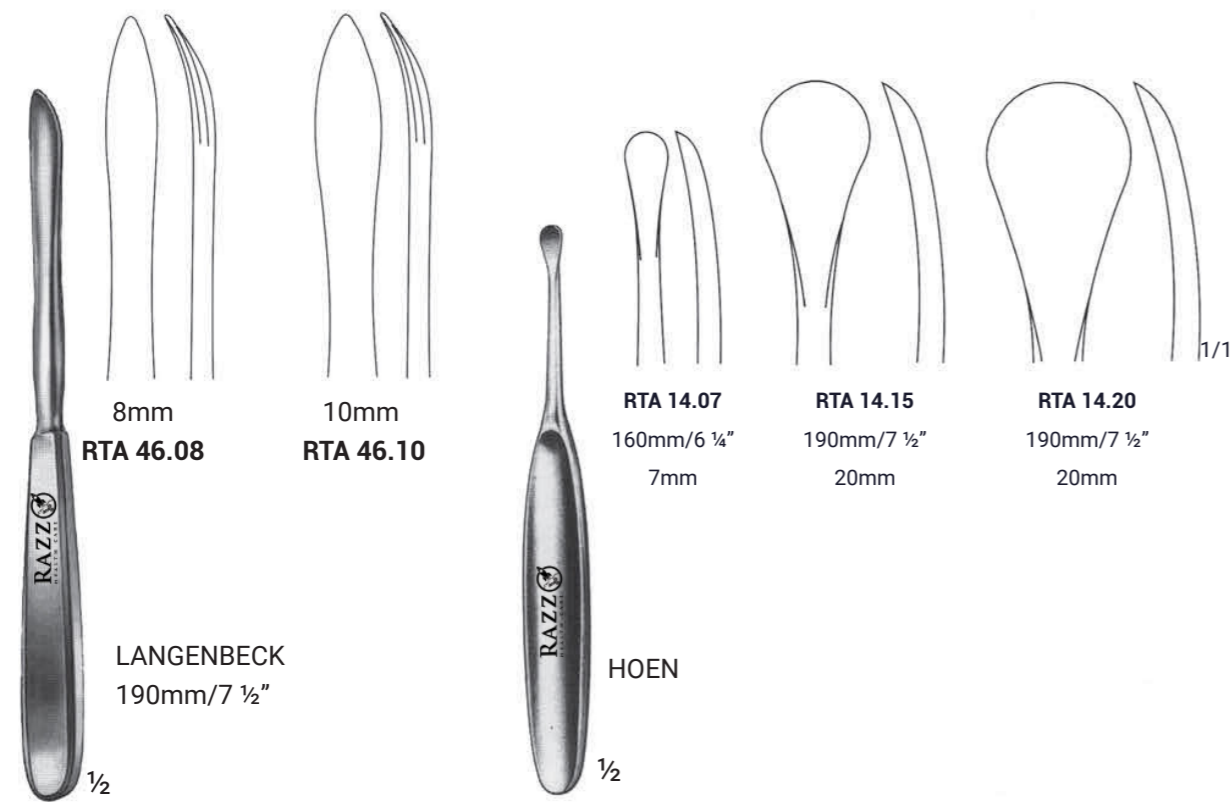
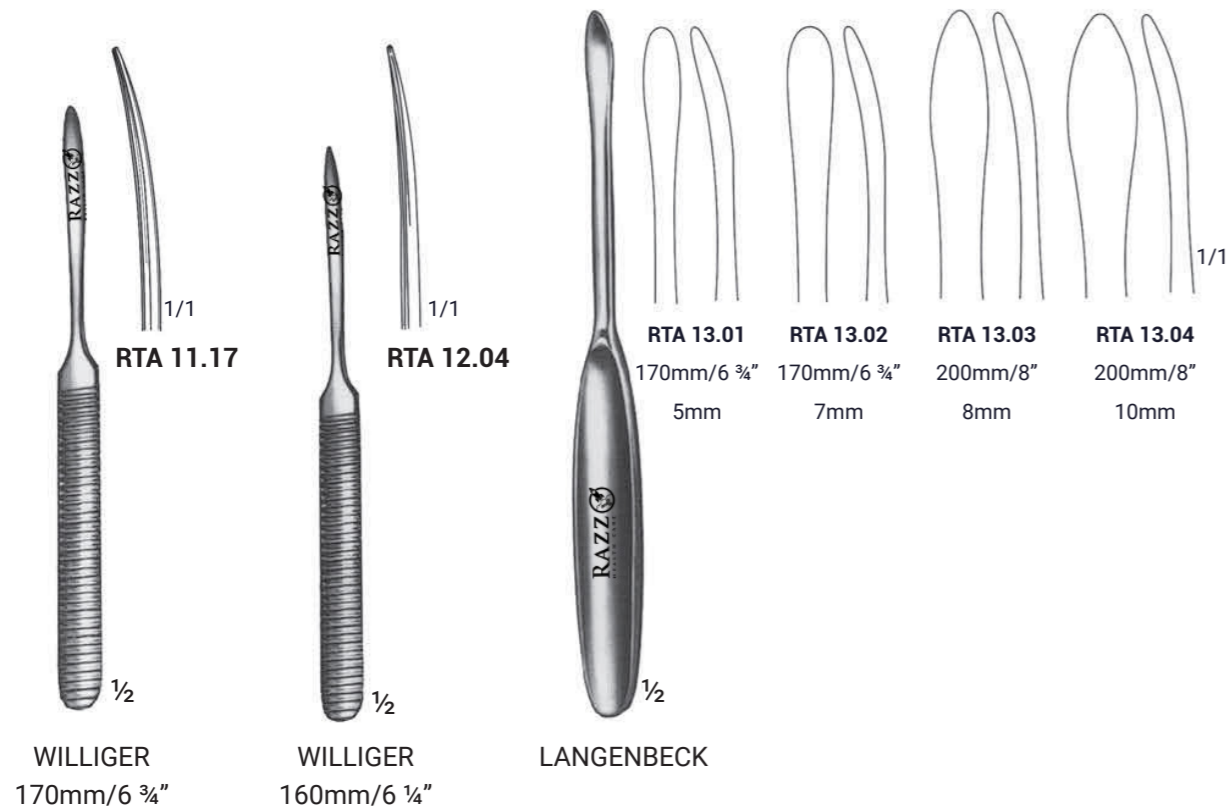

MALLETS

MALLETS

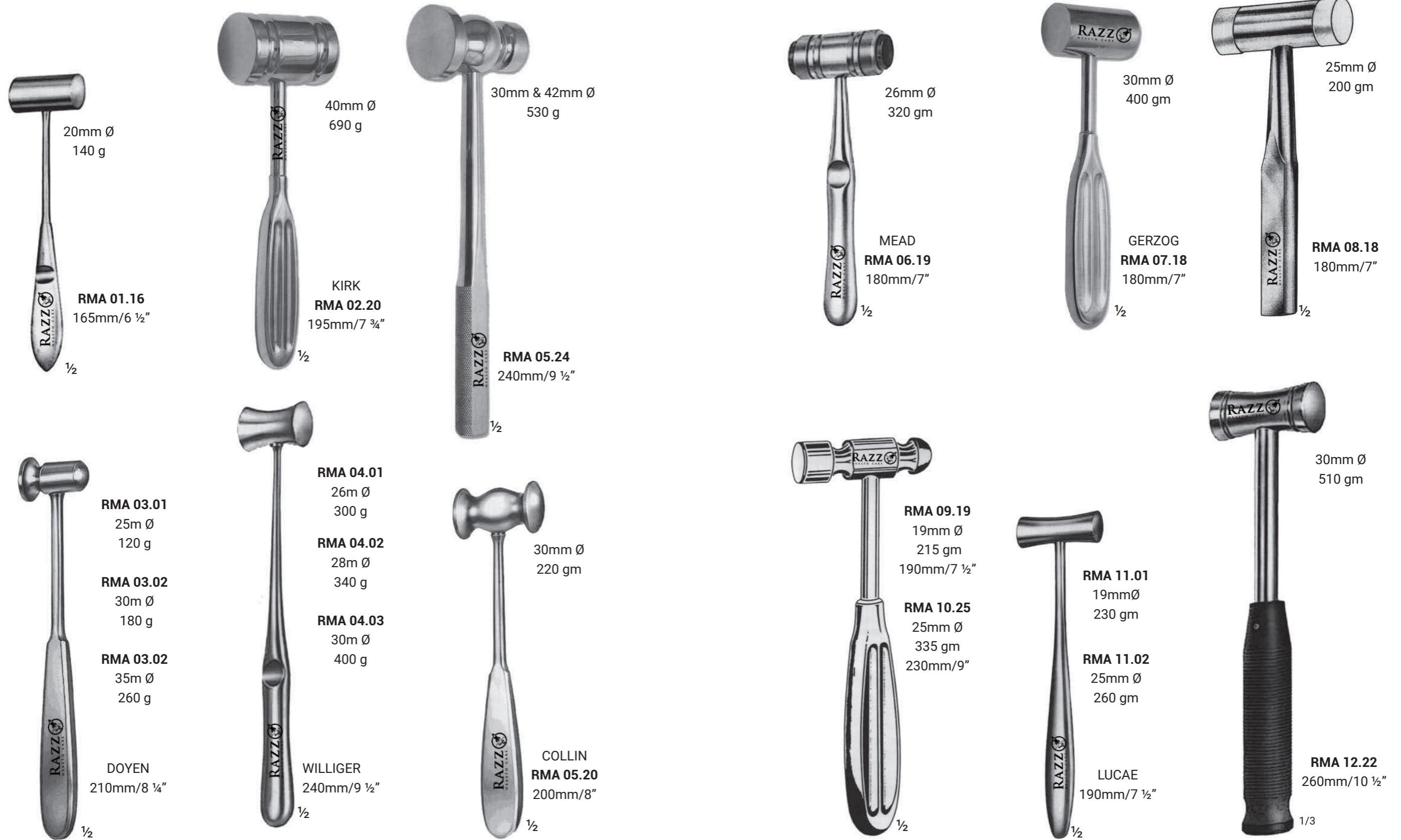

BONE RONGEURS

BONE RONGEURS

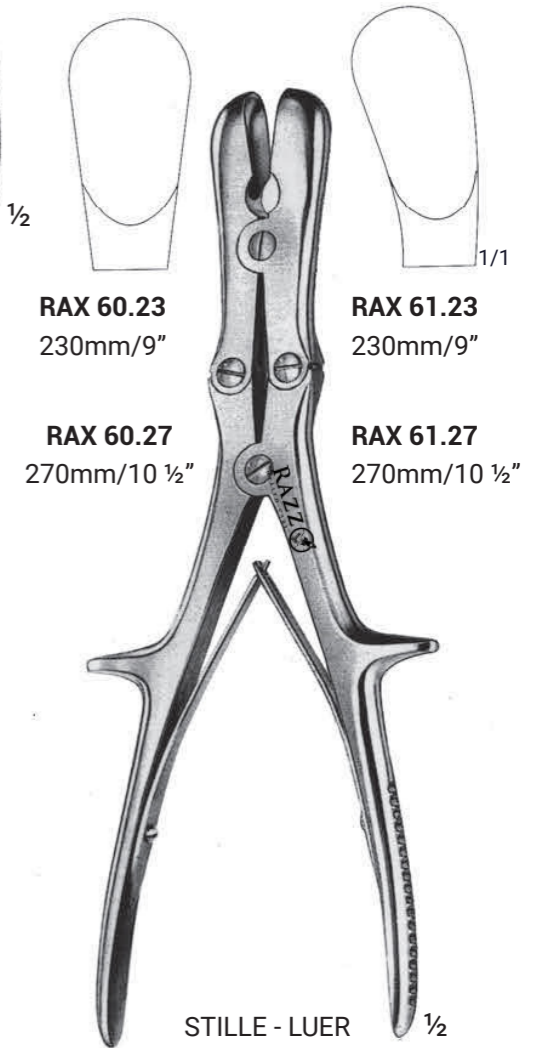
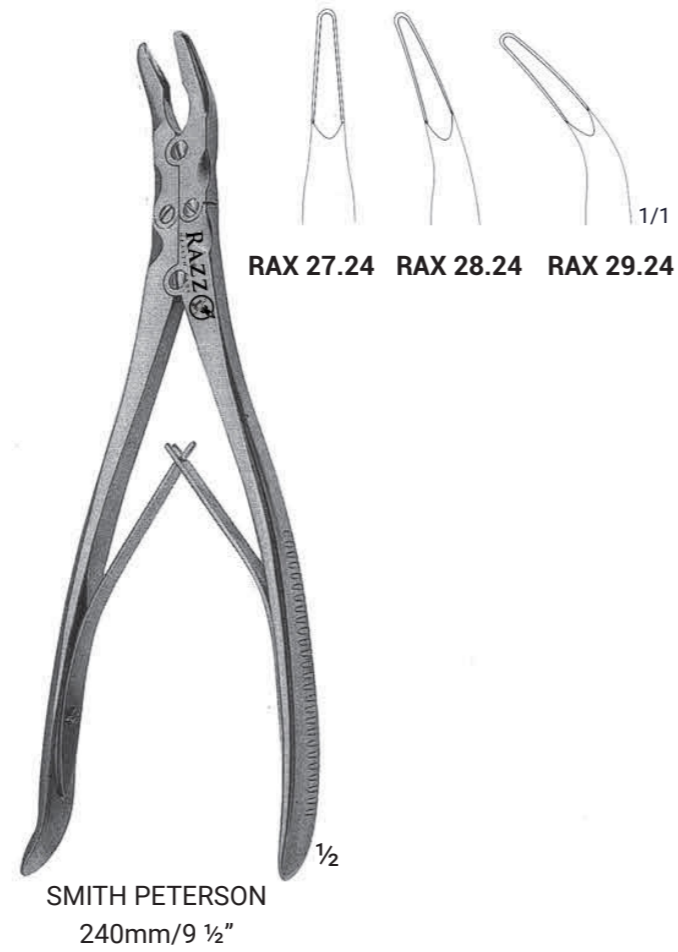

BONE RONGEURS

BONE CUTTING FORCEPS

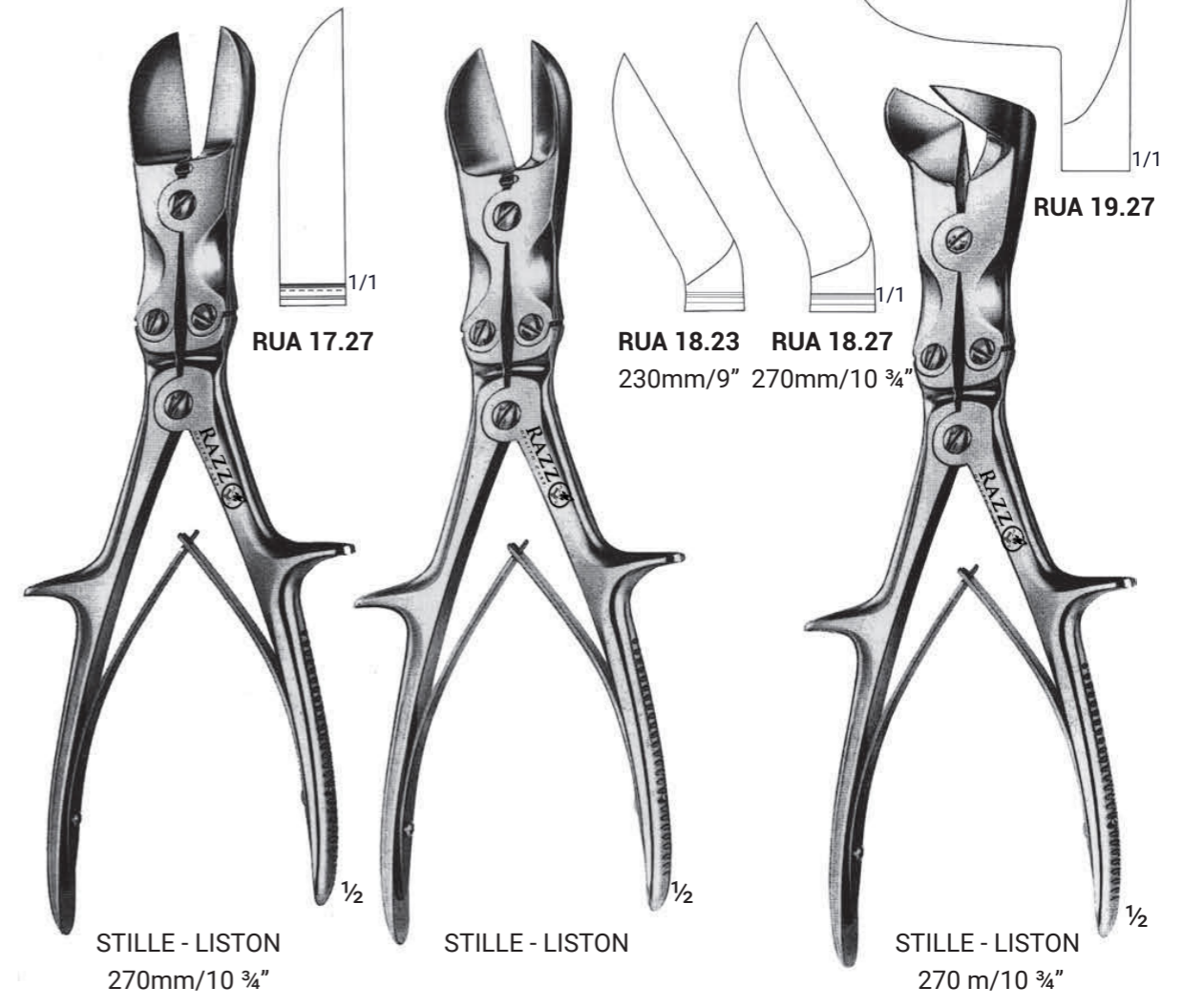
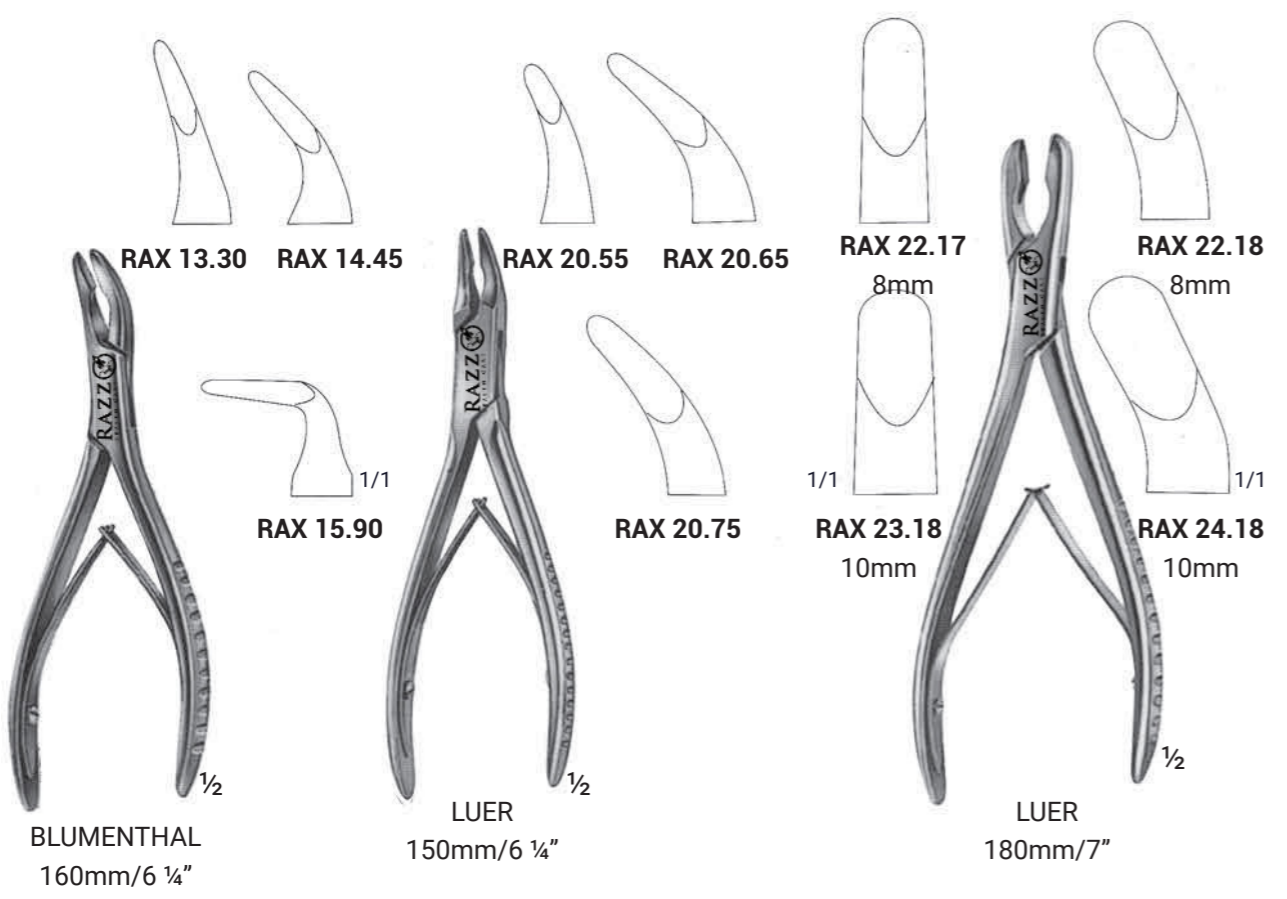
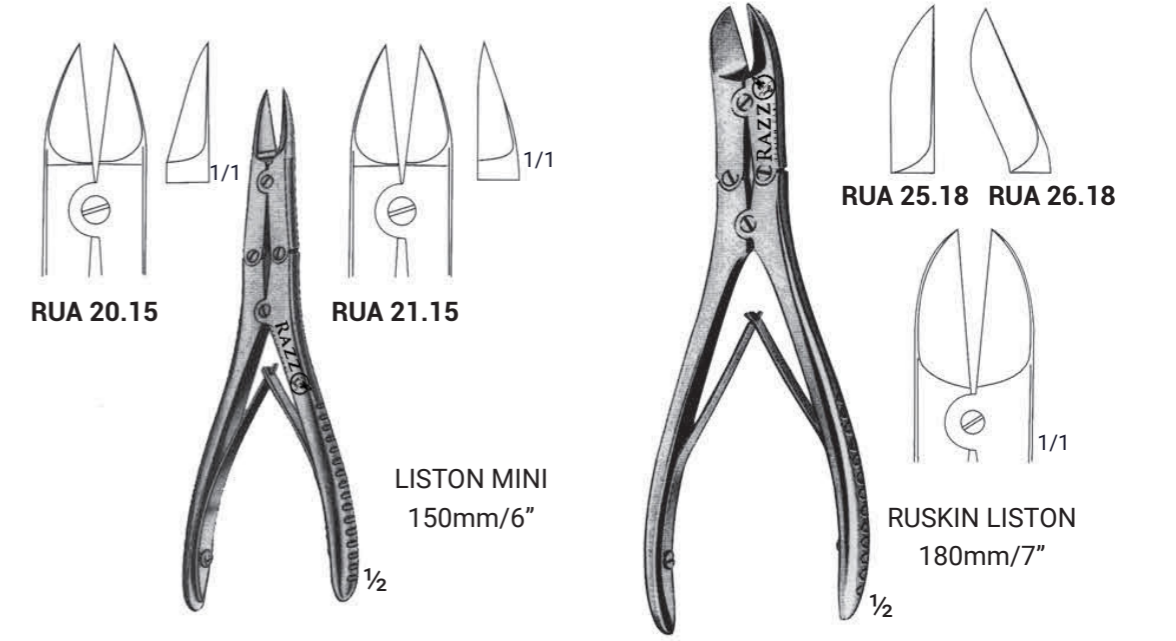
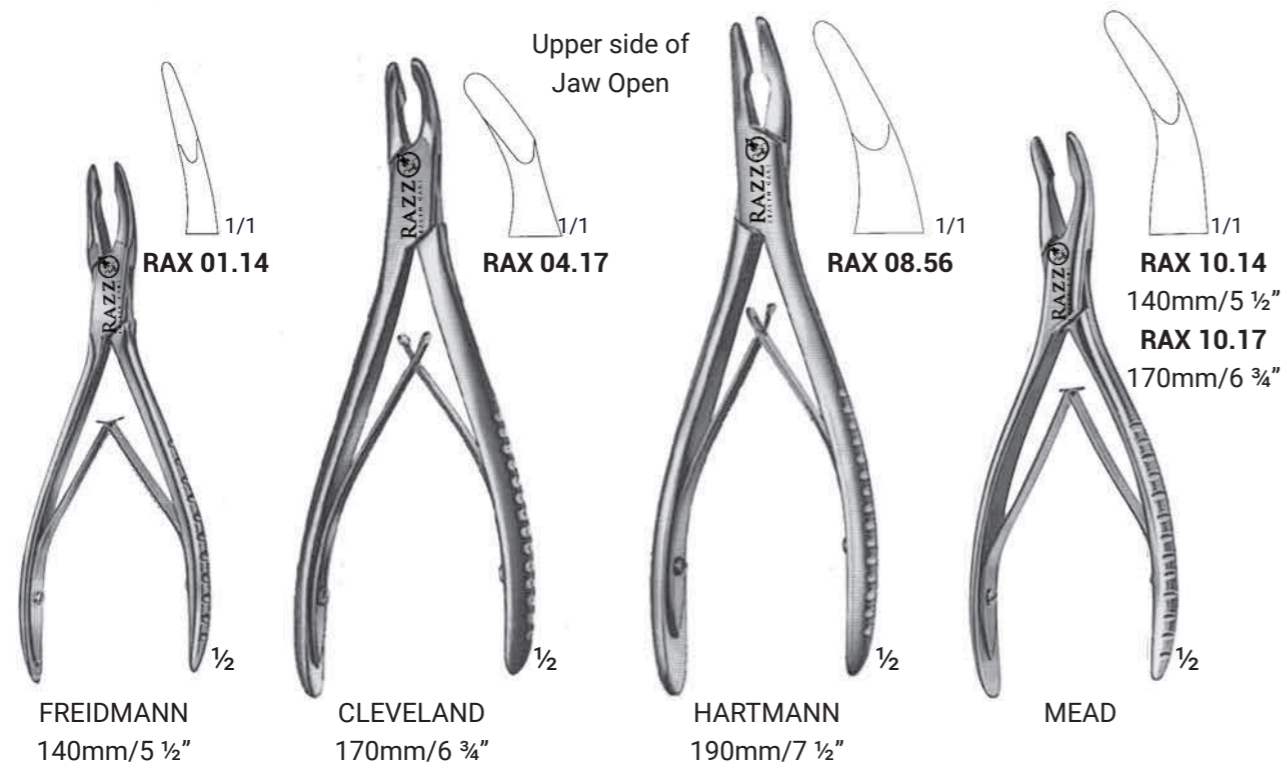

BONE CUTTING FORCEPS

BONE CURETTES

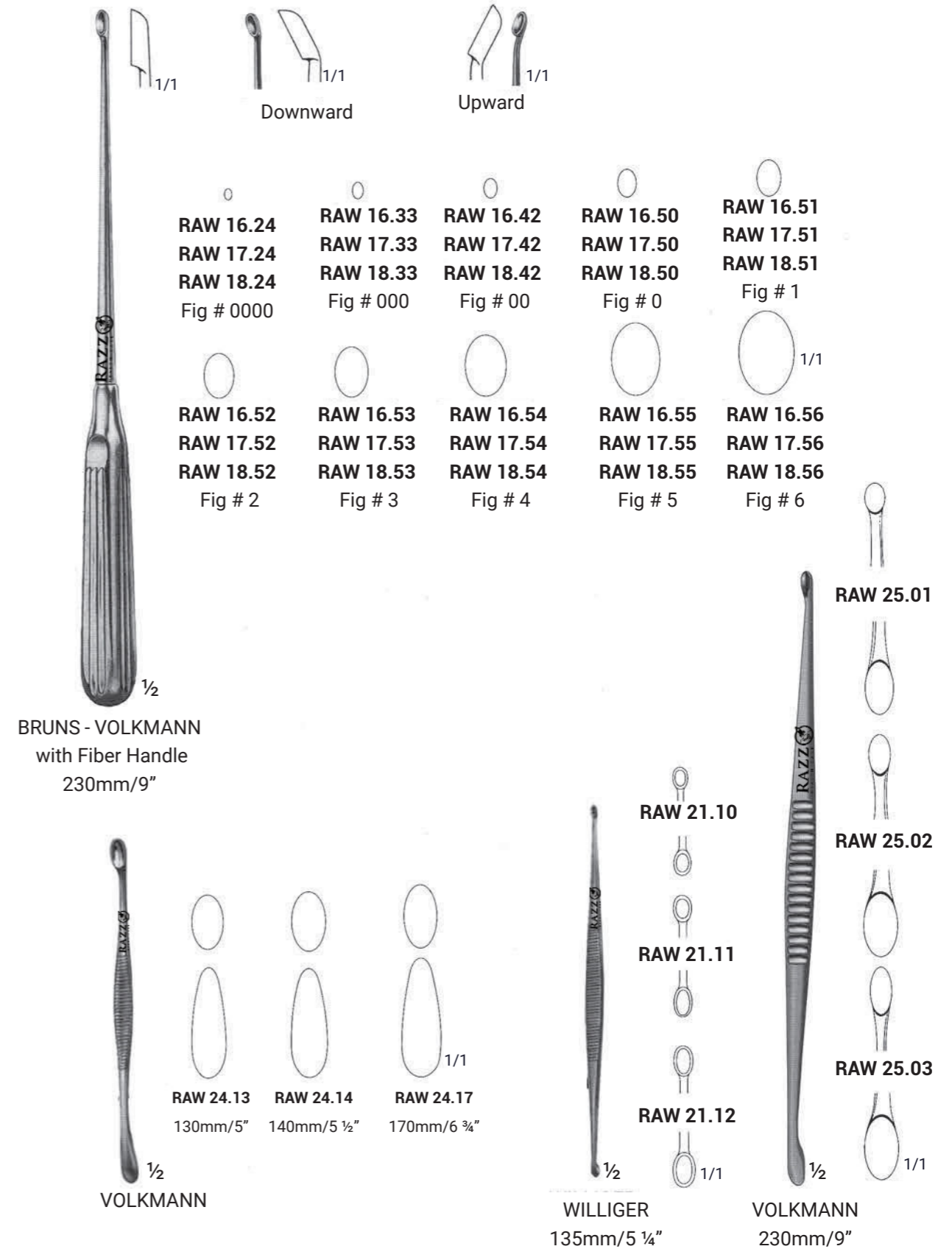
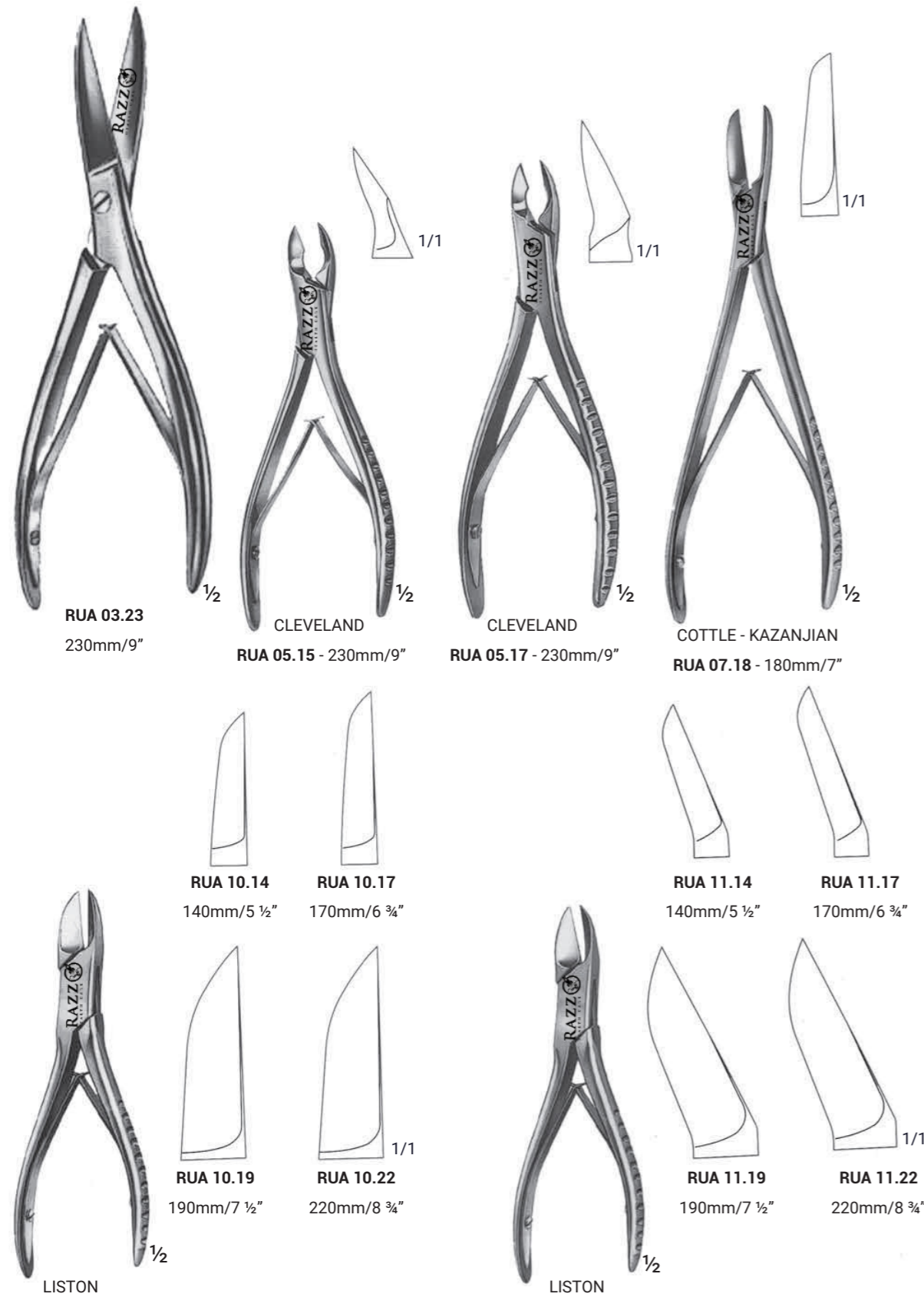

BONE CURETTES

BONE CURETTES



BRUNS
with Fiber Handle
170mm/ 6 3/4"

RAW 03.24 Fig # 0000	RAW 03.33 Fig # 000	RAW 03.42 Fig # 00
RAW 03.50 Fig # 0	RAW 03.51 Fig # 1	RAW 03.52 Fig # 2
RAW 03.53 Fig # 3	RAW 03.54 Fig # 4	RAW 03.55 Fig # 5
	RAW 03.56 Fig # 6	



SPRATT
with Fiber Handle
170mm/6 3/4"

RAW 11.24 Fig # 0000	RAW 11.33 Fig # 000	RAW 11.42 Fig # 00
RAW 11.50 Fig # 0	RAW 11.51 Fig # 1	RAW 11.52 Fig # 2
RAW 11.53 Fig # 3	RAW 11.54 Fig # 4	RAW 11.55 Fig # 5



VOLKMANN
with Fiber Handle
170mm/6 3/4"

RAW 14.24 Fig # 0000	RAW 14.33 Fig # 000	RAW 14.42 Fig # 00
RAW 14.50 Fig # 0	RAW 14.51 Fig # 1	RAW 14.52 Fig # 2
RAW 14.53 Fig # 3	RAW 14.54 Fig # 4	RAW 14.55 Fig # 5
	RAW 14.56 Fig # 6	



HALLE
with Fiber Handle
210mm/8 1/4"

RAW 13.51 Fig # 1
RAW 13.52 Fig # 2
RAW 13.53 Fig # 3



BRUNS
Solid Handle
230mm/9"

RAW 09.24 Fig # 0000
RAW 09.33 Fig # 000
RAW 09.42 Fig # 00
RAW 09.50 Fig # 0
RAW 09.51 Fig # 1
RAW 09.52 Fig # 2
RAW 09.53 Fig # 3
RAW 09.54 Fig # 4
RAW 09.55 Fig # 5



BRUNS
with Fiber Handle
270mm/10 3/4"

RAW 10.64 Fig # 0000	RAW 10.92 Fig # 2
RAW 10.73 Fig # 000	RAW 10.93 Fig # 3
RAW 10.82 Fig # 00	RAW 10.94 Fig # 4
RAW 10.90 Fig # 0	RAW 10.95 Fig # 5
RAW 10.91 Fig # 1	RAW 10.96 Fig # 6



BRUNS
with Fiber Handle
170mm/6 3/4"

RAW 10.50 Fig # 0
RAW 10.51 Fig # 1
RAW 10.52 Fig # 2
RAW 10.53 Fig # 3
RAW 10.54 Fig # 4

BONE OSTEOTOME & GOUGES, MENISCOTOME KNIVES

BONE OSTEOTOME AND GOUGES

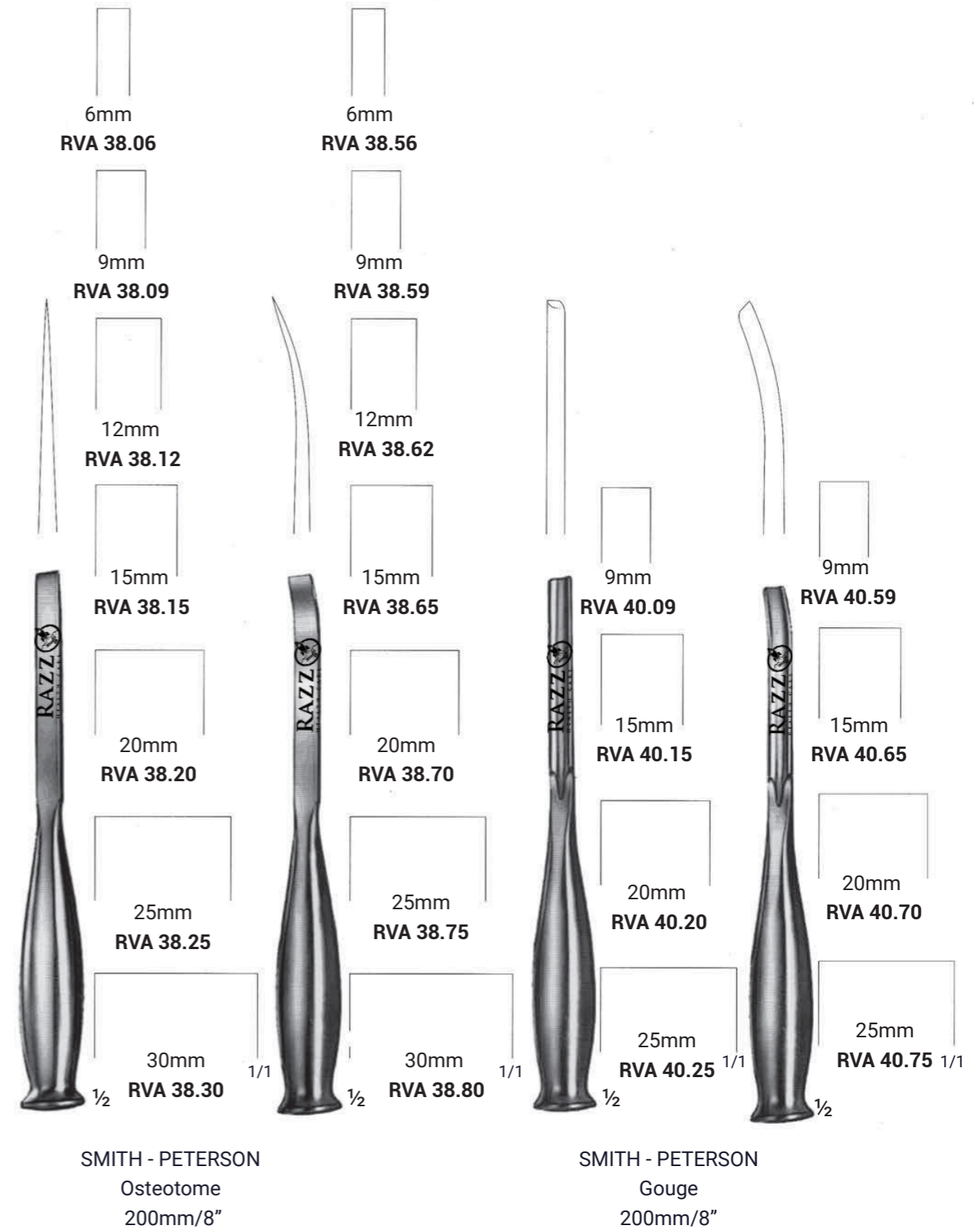
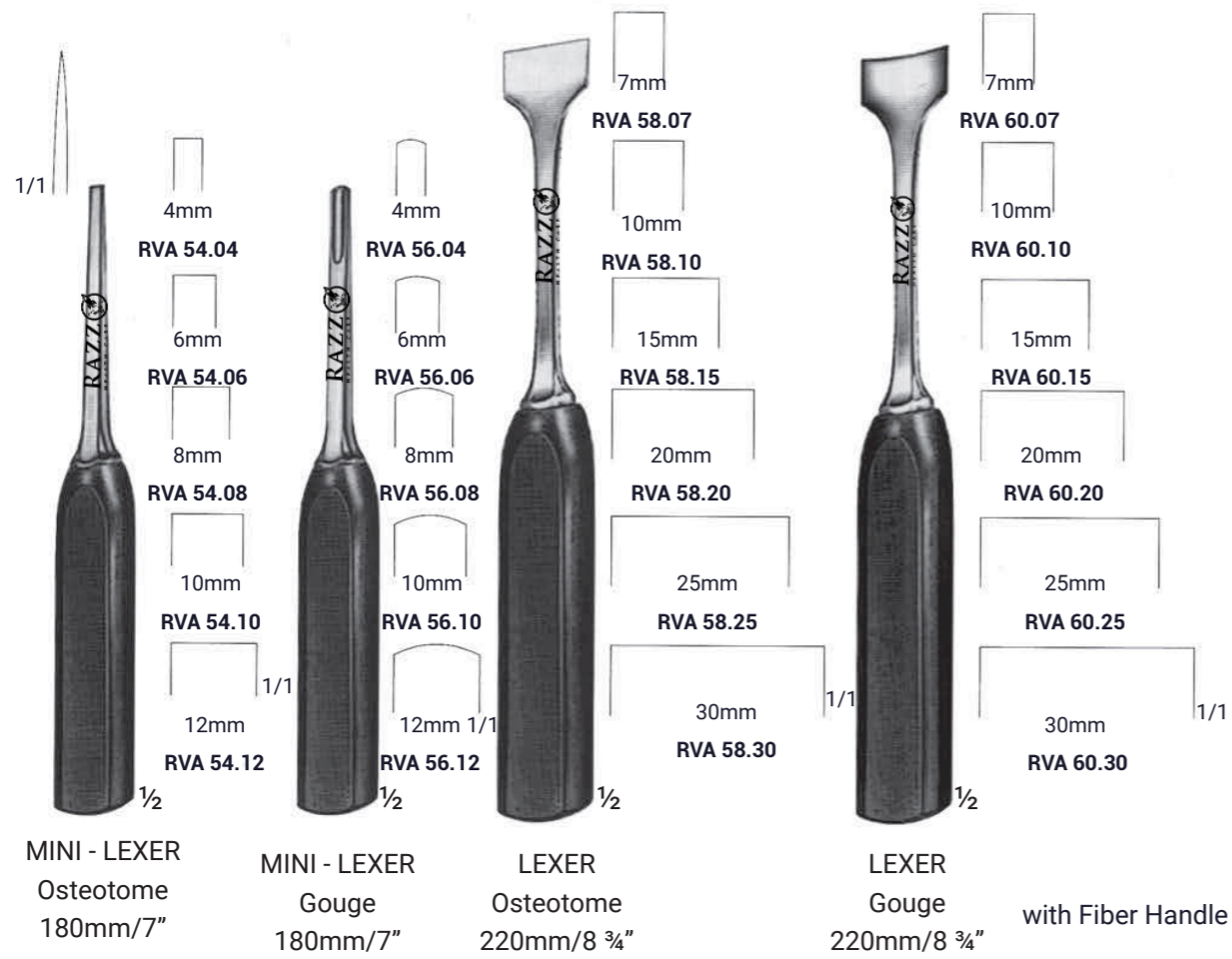

BONE OSTEOTOMES

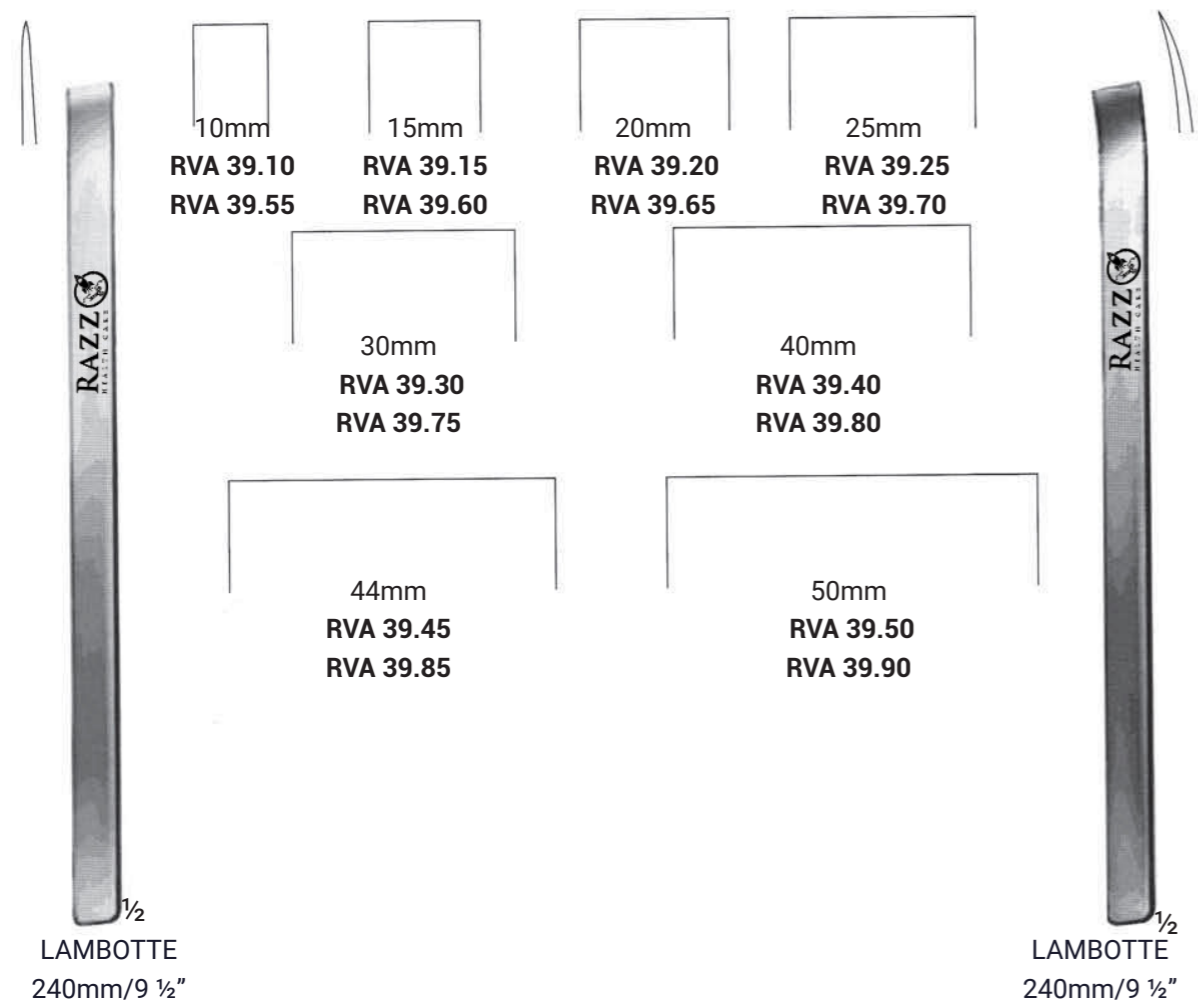
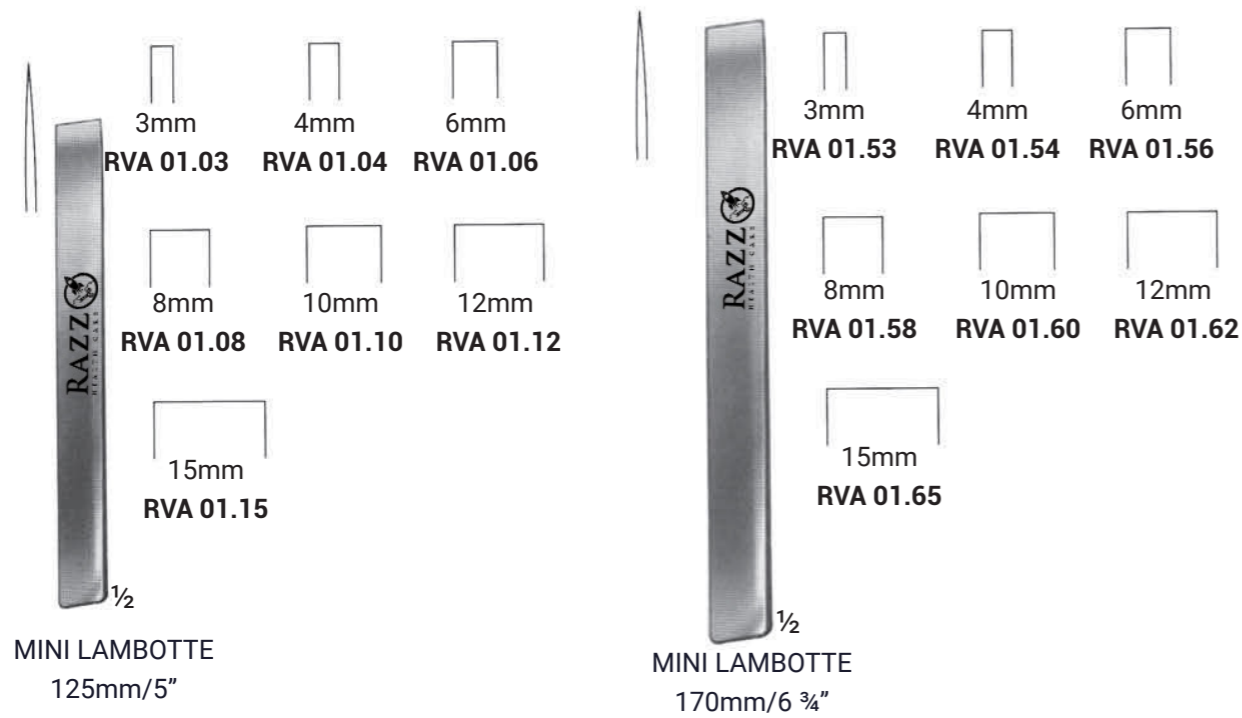

WIRE CUTTING PLIERS WITH T/C

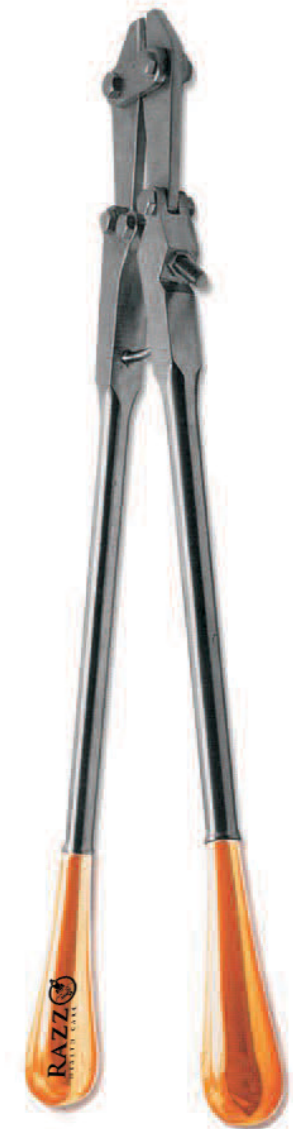
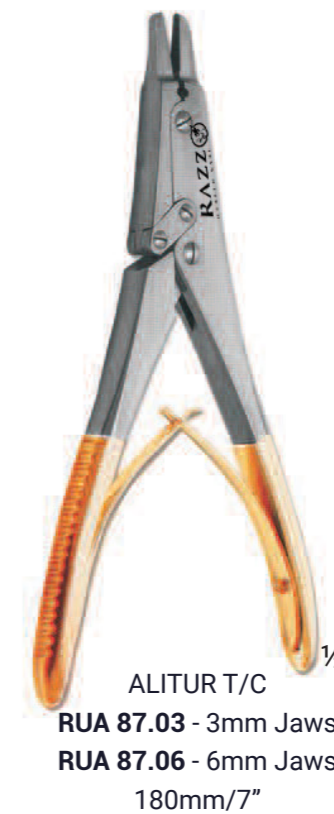

For cutting off Kirschner wires, Tibia head screws bolts, pins upto 6.0mm Ø

RUA 10.56
560mm/22 1/2"
T/C
For hard wire upto Ø 2.5mm

FLAT NOSE PLIERS & WIRE CUTTING PLIERS WITH T/C

AMPUTATING SAWS, GIGLI SAW GUIDES & WIRE SAW HANDLES

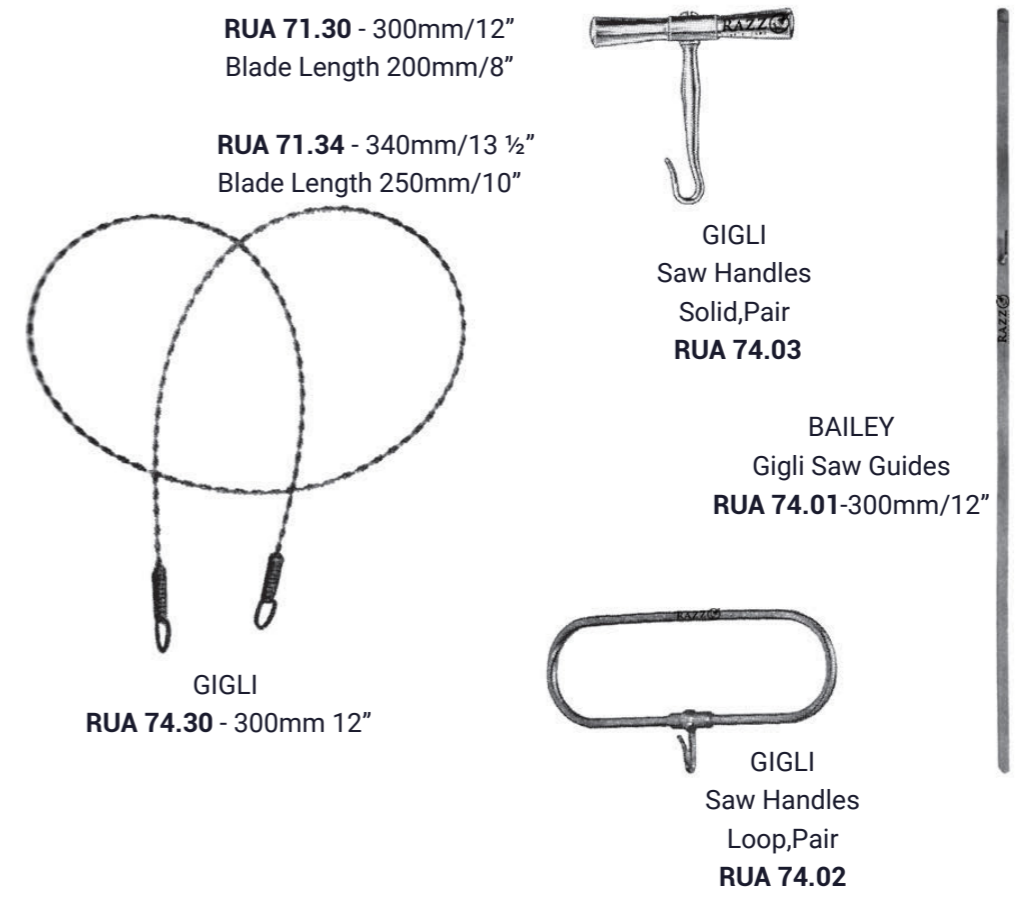
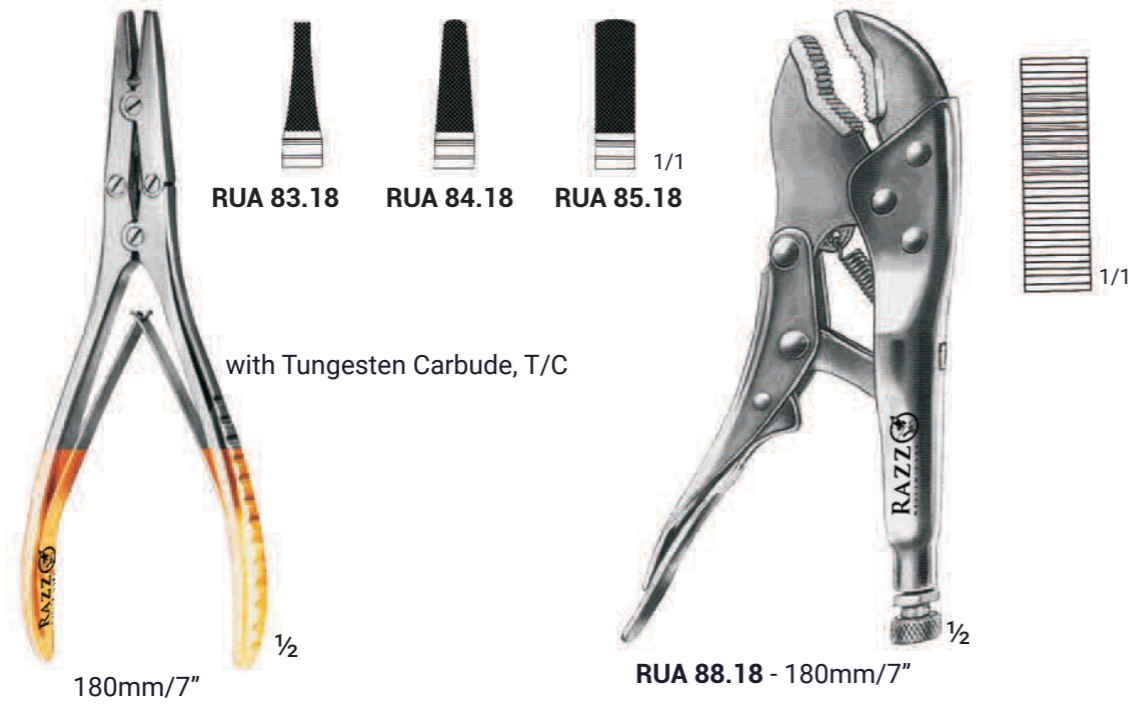

BONE HOLDING FORCEPS

BONE HOLDING FORCEPS

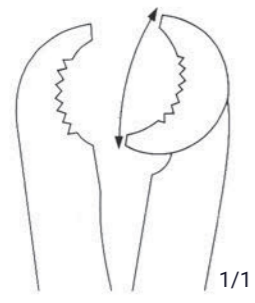

1/1

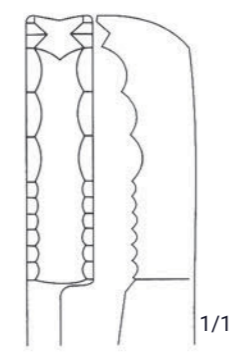

1/1

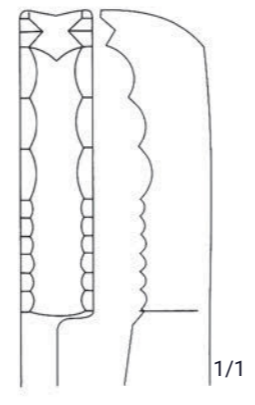

1/1



LAMBOTTE

RUA 62.21 - 210mm/8 1/4"
RUA 62.25 - 250mm/10"
RUA 62.30 - 300mm/12"



FERABEU

RUA 64.23 - 230mm/9"
RUA 64.25 - 250mm/10"



FERABEU - LAMBOTTE
RUA 65.26 - 260mm/10 1/4"

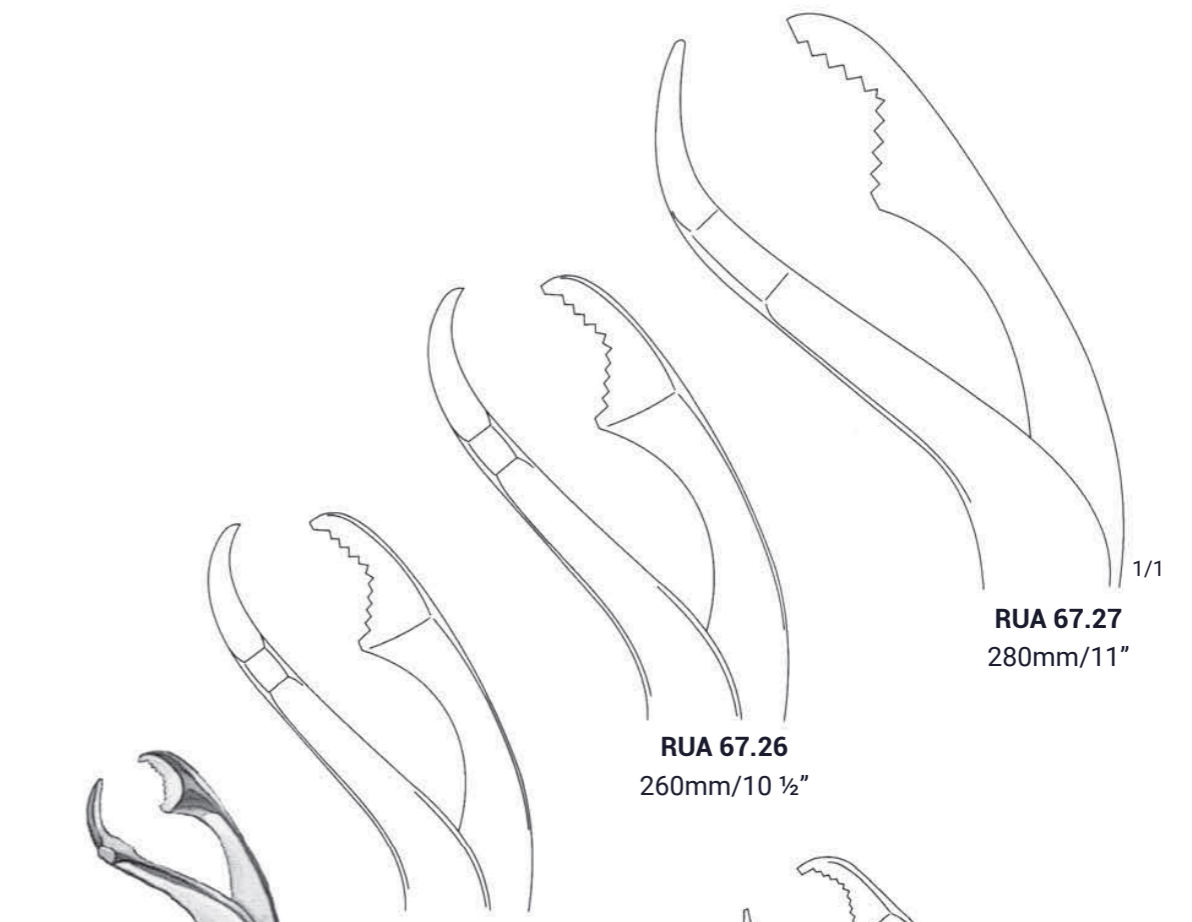

RUA 67.27
280mm/11"

RUA 67.26
260mm/10 1/2"

RUA 67.25
250mm/10"

RUA 66.17

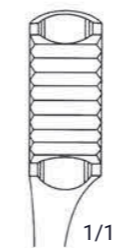

1/1



1/1



VERBRUGGE

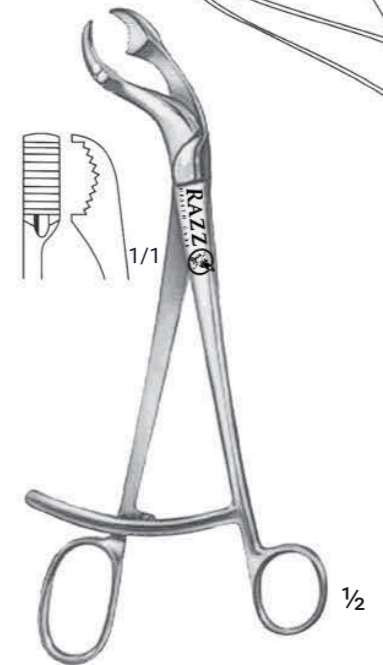

VERBRUGGE
175mm/6 3/4"

BONE HOLDING FORCEPS

BONE HOLDING FORCEPS

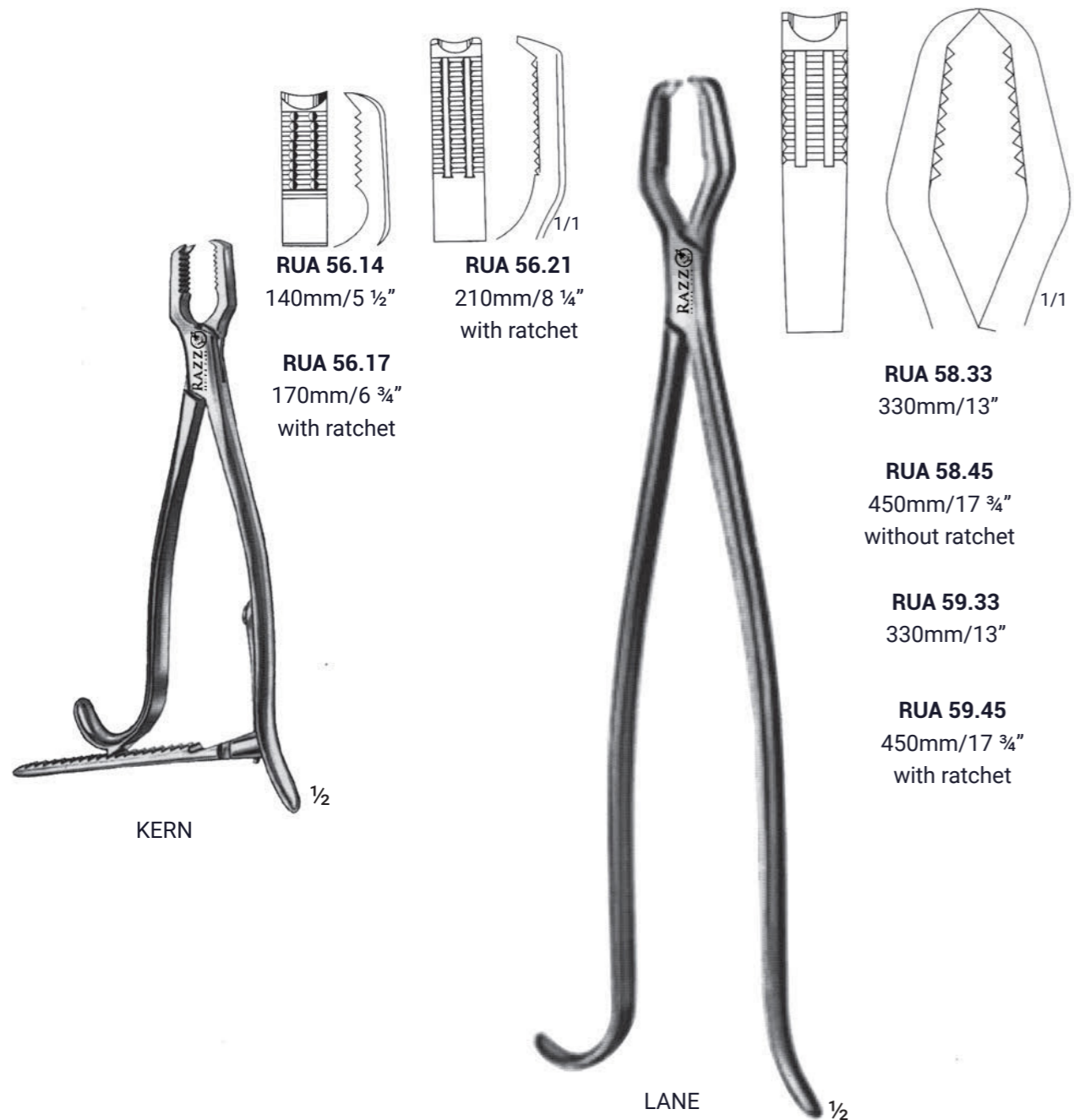

RUA 56.14
140mm/5 1/2"
RUA 56.17
170mm/6 3/4"
with ratchet

RUA 56.21
210mm/8 1/4"
with ratchet

RUA 58.33
330mm/13"

RUA 58.45
450mm/17 3/4"
without ratchet

RUA 59.33
330mm/13"

RUA 59.45
450mm/17 3/4"
with ratchet

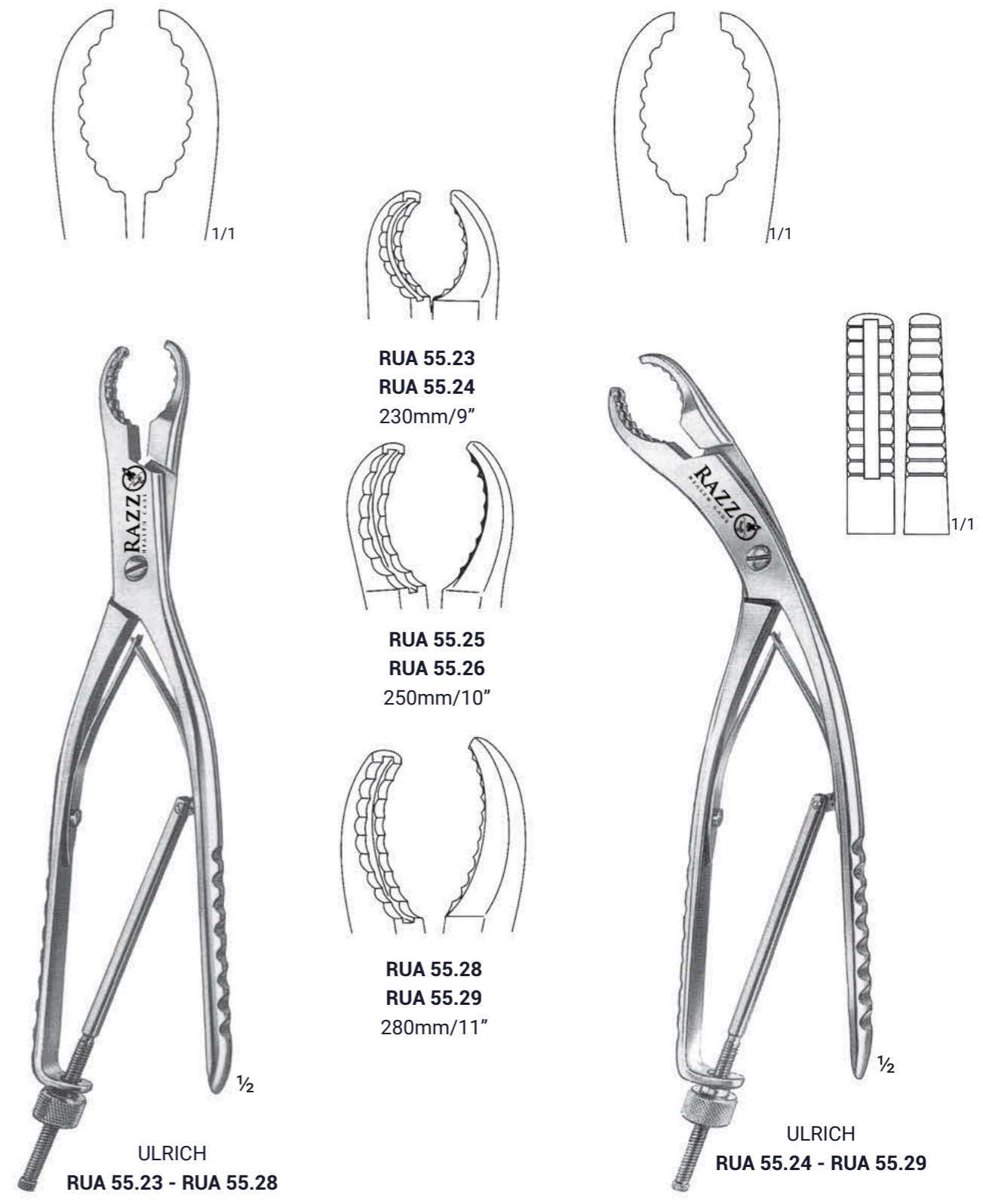

RUA 55.23
RUA 55.24
230mm/9"

RUA 55.25
RUA 55.26
250mm/10"

RUA 55.28
RUA 55.29
280mm/11"

ULRICH
RUA 55.23 - RUA 55.28

ULRICH
RUA 55.24 - RUA 55.29

BONE HOLDING CLAMPS

BONE HOLDING CLAMPS

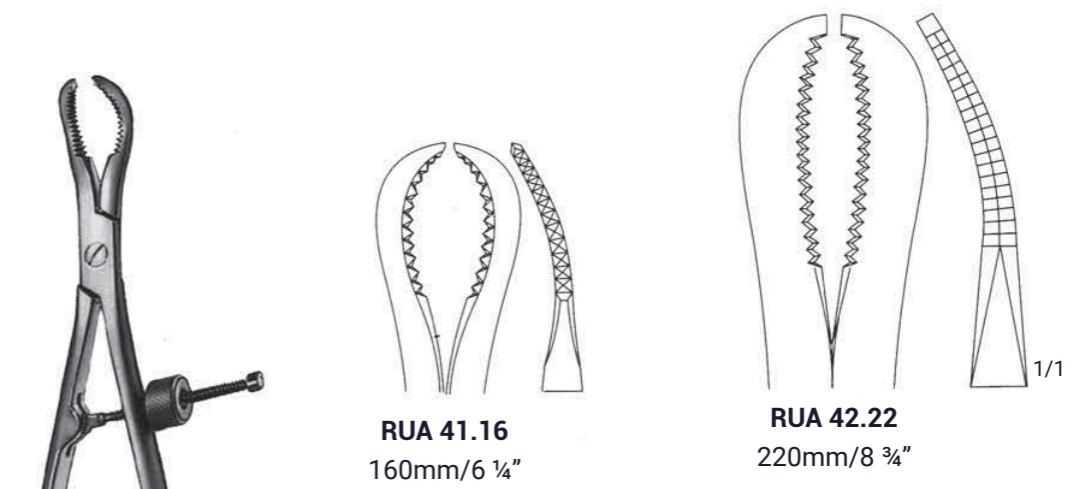
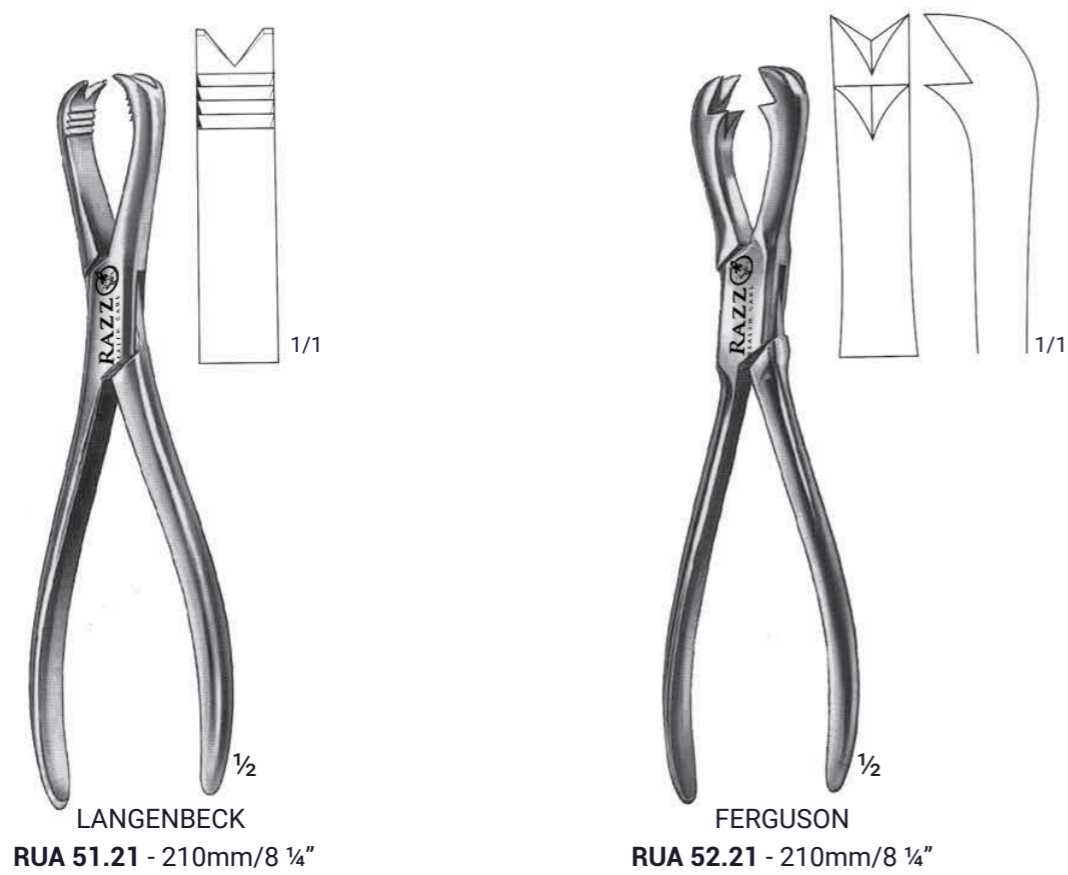
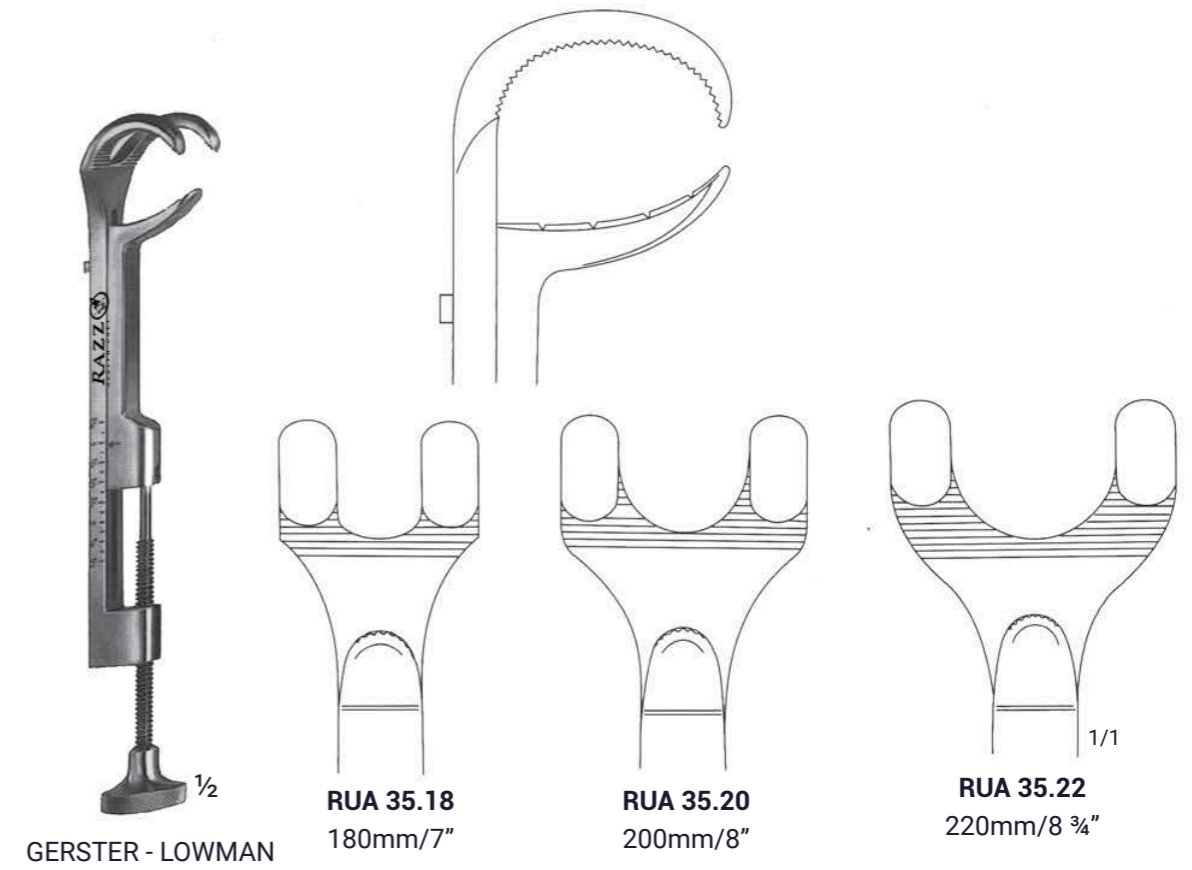
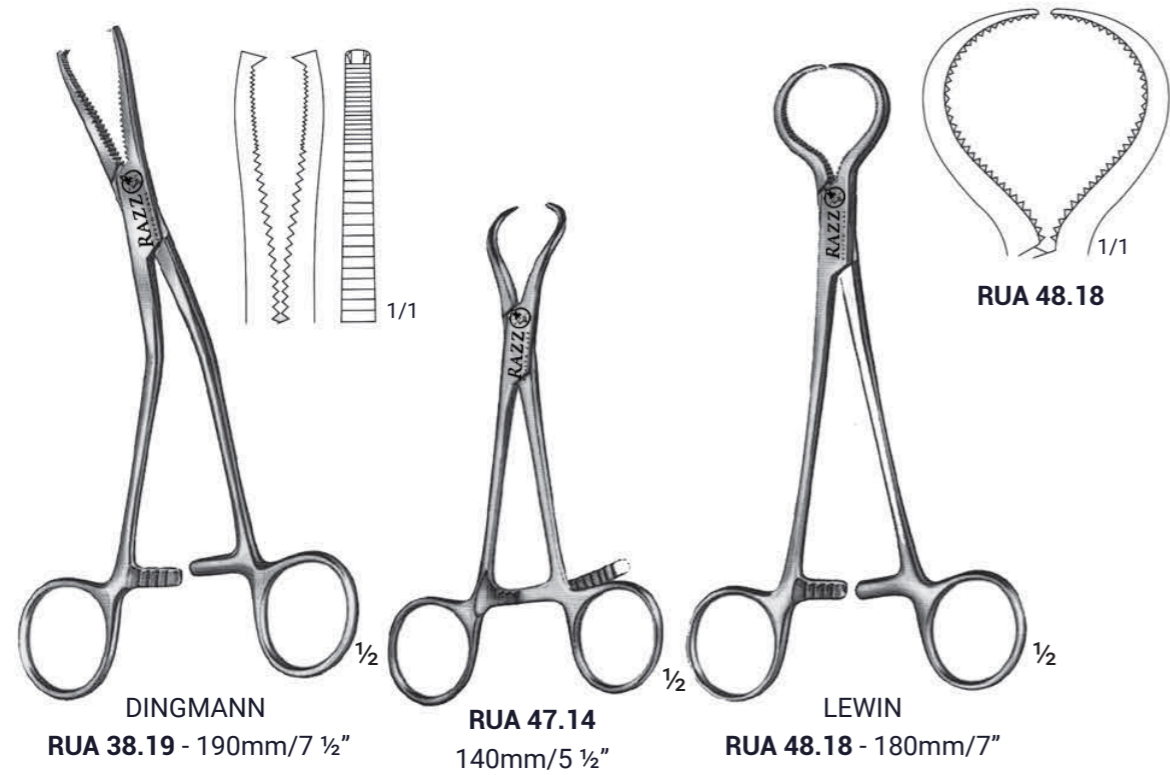



HOHMANN
RTA 64.22 250mm/10"
RTA 64.24 280mm/11"
RTA 64.33 290mm/11 1/2"
RTA 64.43 240mm/9 1/2"

LANGE - HOHMANN
RTA 66.22 - 260mm/10 1/4"



HOHMANN
RTA 62.08 220mm/8 3/4"
RTA 62.18 240mm/9 1/2"
RTA 62.43 240mm/9 1/2"
RTA 62.70 290mm/11 1/2"

BANDAGE SCISSORS & PLASTER SHEARS

PLASTER SHEARS BANDAGE SCISSORS & T/C

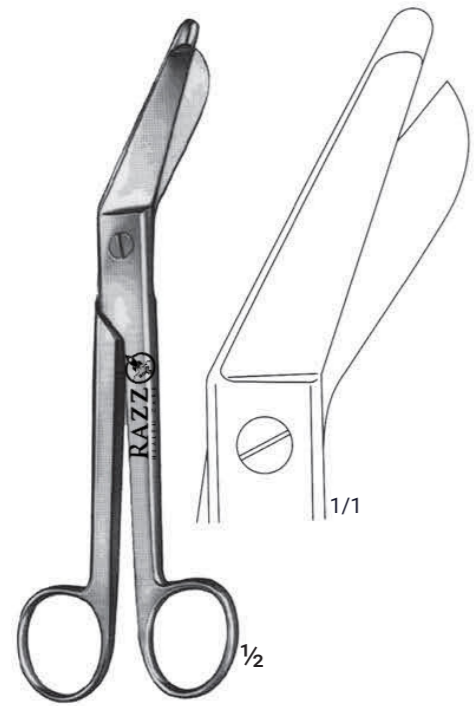

ESMARCH
RAL 04.20 - 200mm/8"
RAL 04.22 - 220mm/8 3/4"



ESMARCH
RAL 05.23 - 230mm/9"



BRUNS
RAL 06.23
235mm/9 1/4"



UNIVERSAL
RAL 08.15 - 150mm/6"
RAL 08.18 - 180mm/7"
(Black Handle)
other Colours Available



BRUNS, T/C
RAL 06.73 - 235mm/9 1/4"



LISTER, T/C
RAL 12.64 - 140mm/5 1/2"
RAL 12.68 - 180mm/7"

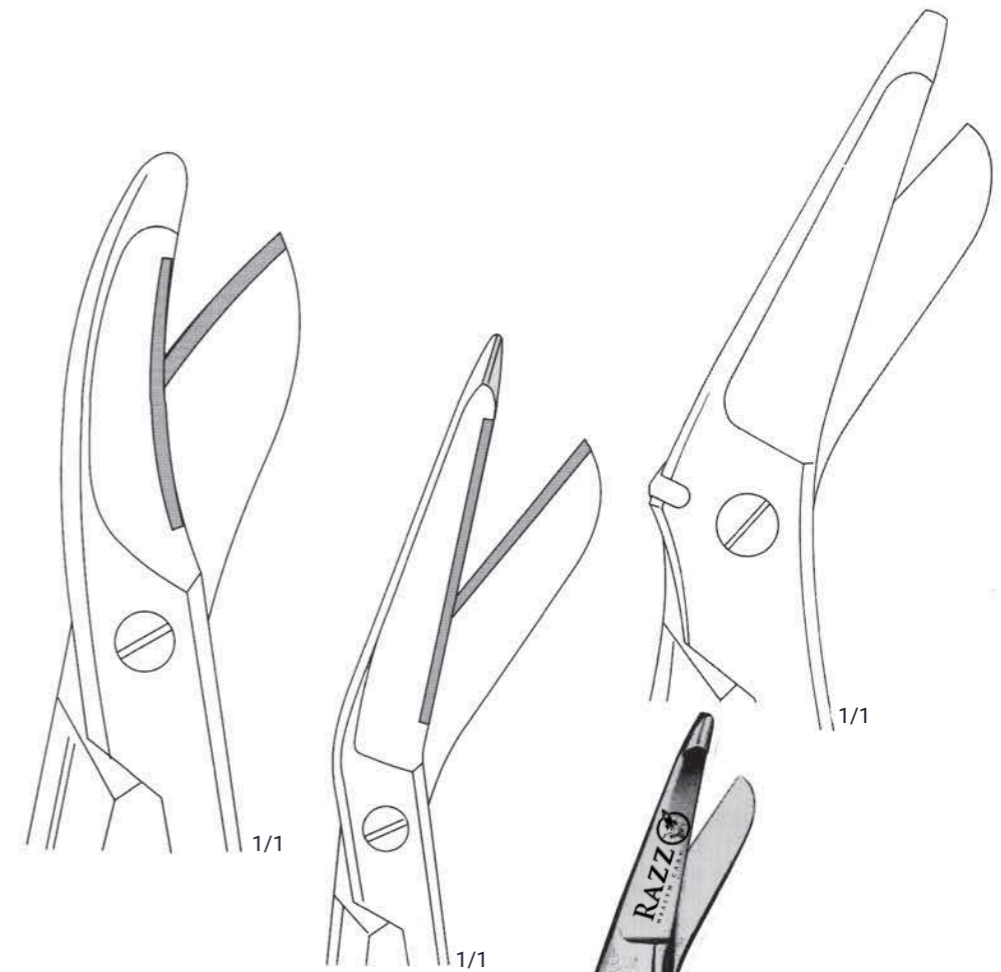

RAL 15.21 - 210mm/8 1/4"

BANDAGE SCISSORS & PLASTER SHEARS

PLASTER CAST BENDER, SPREADER & PLASTER CAST KNIVES

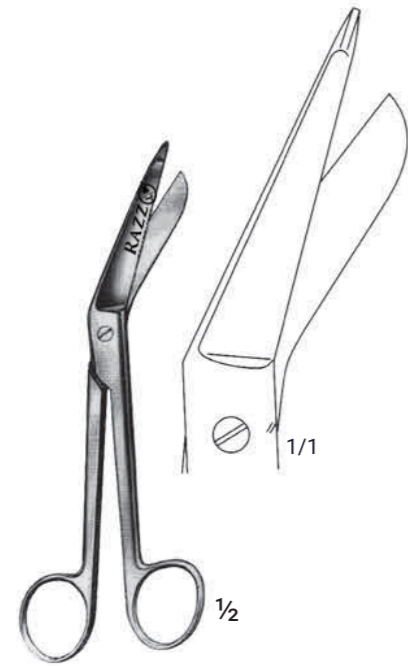

LISTER
RAL 12.11 - 115mm/4 1/2"
RAL 12.14 - 140mm/5 1/2"
RAL 12.18 - 180mm/7"
RAL 12.20 - 200mm/8"



STILLE
RAL 01.23 - **RAL 01.37**

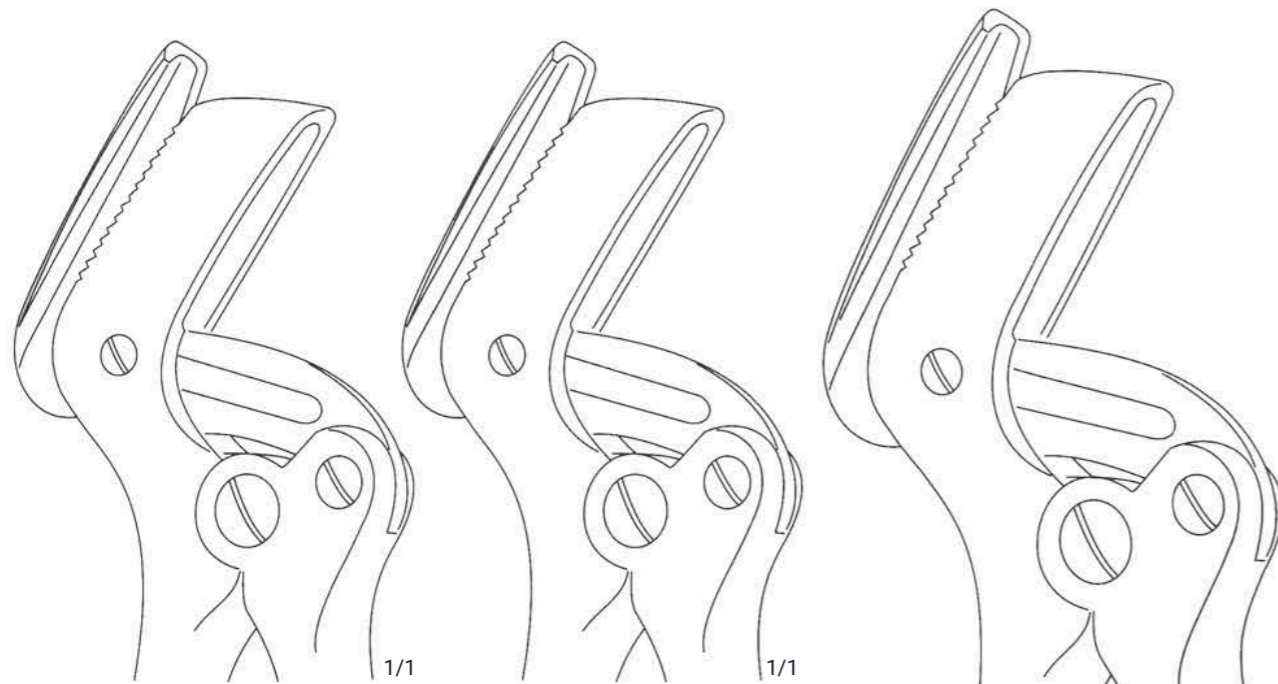

RAL 01.23
 230mm/9"

RAL 01.26
 260mm/10 1/4"

RAL 01.37
 370mm/14 1/2"



WOLFF - BOEHLER
RAQ 04.18 - **RAQ 04.24**



RAQ 04.18
 180mm/7"



RAQ 04.24
 240mm/9 1/2"



HENNING
RAQ 05.27 - 270mm/10 3/4"

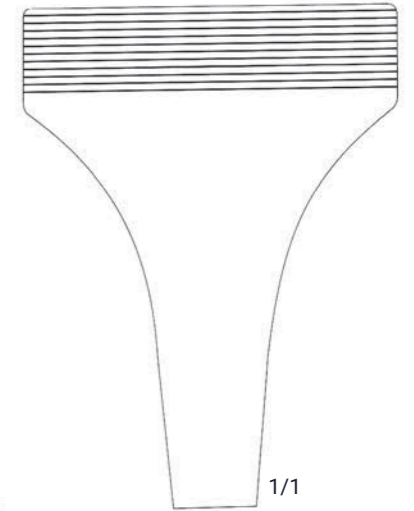

1/1



ENGEL
RAQ 10.15
 150mm/6"



ESMARCH
RAQ 11.18
 180mm/7"



HOPKINS
RAQ 12.20
 200mm/8"



REINER
RAQ 13.19
 190mm/7 1/2"

WIRE CUTTING SCISSORS

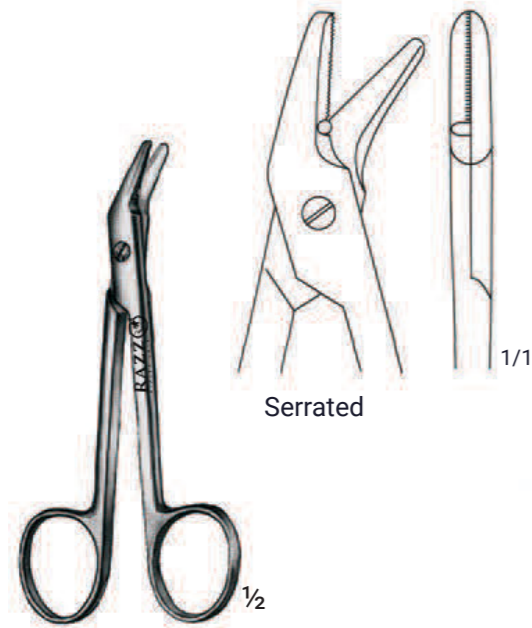

UNIVERSAL
RSA 23.12
120mm/4 3/4"

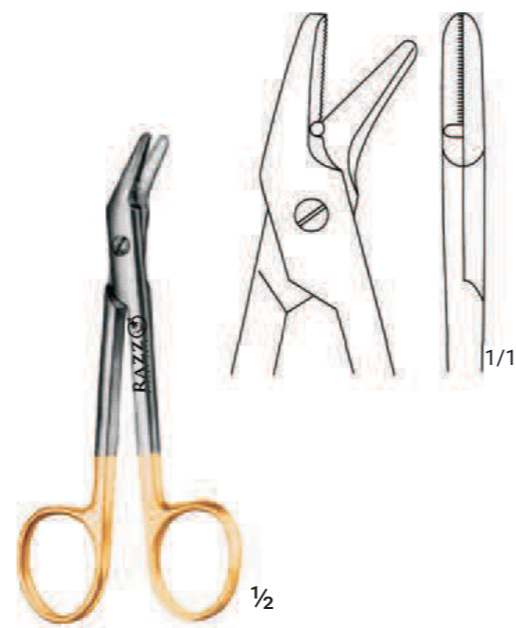

UNIVERSAL T/C
RSA 24.12
120mm/4 3/4"

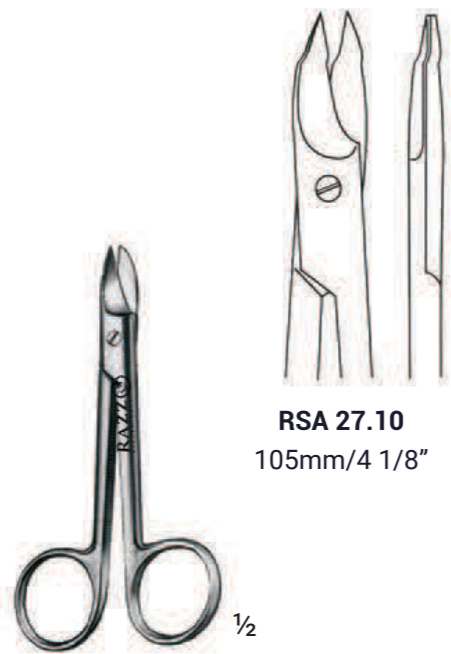

BEE BEE

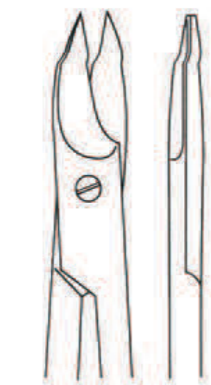

RSA 27.10
105mm/4 1/8"



RSA 28.10
105mm/4 1/8"

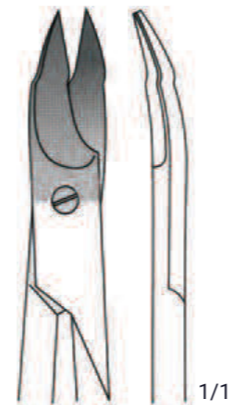

RSA 29.10
105mm/4 1/8"
One blade Serrated



EAR INSTRUMENTS

TUNING FORKS

EAR SPECULA



RALKS
RAC 13.28
C 128
1/2



RALKS
RAC 14.56
C¹ 256
1/2



RALKS
RAC 15.12
C² 512
1/2



RALKS
RAC 16.24
C³ 1024
1/2



RALKS
RAC 17.48
C⁴ 2048
1/2

- Ø 3mm
Fig 0
- Ø 4mm
Fig 1
- 1/1 ○ Ø 5mm
Fig 2

- Ø 4mm
Fig 1
- Ø 5mm
Fig 2
- Ø 6.0mm
Fig 3
- 1/1 ○ Ø 7.5mm
Fig 4

- Ø 4.5mm
- Ø 5.5mm
- Ø 6.5mm
- 1/1 ○ Ø 7.5mm



HARTMAN
(For Children)
RAC 28.07
Set of 3 (Fig 0,1,2)



HARTMAN
(For Adults)
RAC 28.03 Set of 3(Fig 2,3,4)
RAC 28.04 Set of 4(Fig 1,2,3,4)



GRUBER
RAC 30.20 (Set of 4)



LUCAE
RAC 18.10
C - 128
1/2



LUCAE
RAC 18.09
C¹ - 256
1/2



LUCAE
RAC 18.08
C² - 512
1/2



LUCAE
RAC 18.17
C³ - 1024
1/2



LUCAE
RAC 18.19
C⁴ - 2048
1/2



LUCAE
RAC 18.20
C⁵ - 4096
1/2

- Ø 4.5mm
Fig 1
- Ø 5.5mm
Fig 2
- Ø 6.5mm
Fig 3
- Ø 7.5mm
Fig 4

- Ø 5.5mm
- Ø 6.5mm
- Ø 7.5mm
- Ø 8.5mm
- Ø 9.5mm
- Ø 10.5mm
- 1/1 ○ Ø 11.5mm

- Ø 3.0mm
Fig 1
- Ø 4.5mm
Fig 2
- Ø 5.5mm
Fig 3
- 1/1 ○ Ø 6.5mm
Fig 4



TOYBEE
(For Adults)
RAC 32.03 set of 3 (Fig 2,3,4)
RAC 32.04 set of 4 (Fig 1,2,3,4)



FARRIOR
(Black)
RAC 34.55
Set of 7



POLITZER
RAC 35.51
Set of 3 (Fig 1,2,3)
RAC 35.52
Set of 4 (Fig 1,2,3,4)

EUSTACHIAN CATHETERS, EAR SYRINGE & EAR CURETTES

SINUS WASH CANULAE & NASAL SNARES



Ø 2.5mm
RAC 63.07
 Ø 3mm
RAC 63.09
 Ø 3.5mm
RAC 63.11
 Ø 4mm
RAC 63.12
 Ø 5mm
RAC 63.15
 HARTMANN
RAC 63.07 - RAC 63.15
 140mm/5 1/2"



RAC 66.11 Conical tip
RAC 66.12 Bulbous tip
RAC 66.10 Shield
RAC 66.02 = 50ml
RAC 66.04 = 100ml

Ear Syringe Complete with 1 bulbous and 1 conical tip and 1 protective shield.



Sharp
RAC 70.00 Fig # 0
RAC 70.01 Fig # 1
RAC 70.02 Fig # 2
RAC 70.03 Fig # 3
 Blunt
RAC 70.20 Fig # 0
RAC 70.21 Fig # 1
RAC 70.22 Fig # 2
RAC 70.23 Fig # 3
 BUCK
RAC 70.00 - RAC 70.23
 165mm/6 1/2"

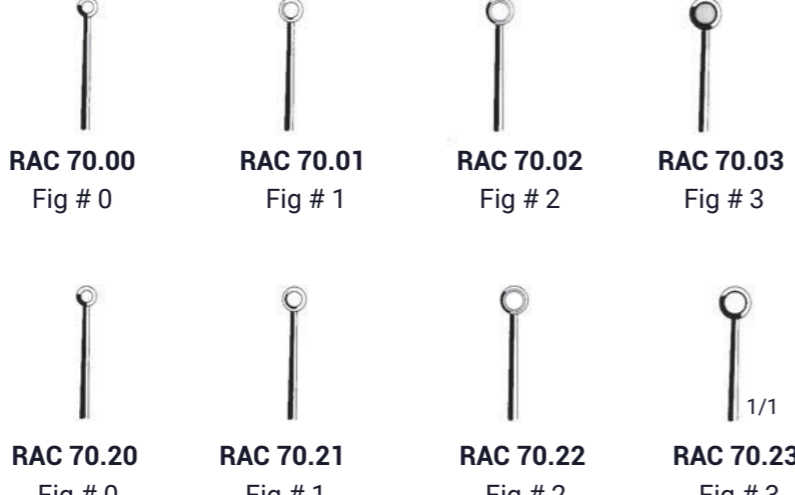

RAC 70.00 Fig # 0
RAC 70.01 Fig # 1
RAC 70.02 Fig # 2
RAC 70.03 Fig # 3
RAC 70.20 Fig # 0
RAC 70.21 Fig # 1
RAC 70.22 Fig # 2
RAC 70.23 Fig # 3



KRAUS
RAL 07.05
 260mm/10 1/4"

KRAUS VOSS
RAL 07.25
 260mm/10 1/4"



Ø 3mm
EICKEN-KILLIAN
RAL 01.14
 140mm/5 1/2"

SIEBENMANN
RAL 02.15 - Ø 1.5mm
RAL 02.17 - Ø 1.7mm
RAL 02.20 - Ø 2.0mm
RAL 02.25 - Ø 2.5mm
RAL 02.30 - Ø 3.0mm



RAL 07.30 - 0.3mm Ø
RAL 07.40 - 0.4mm Ø
 Coil / 10 metre



RAL 07.52 - 0.3mm Ø
 Package / 100

LARYNGEAL MIRRORS & ADENOID CURRETTES

PUNCH FORCEPS, CURRETTES & ELEVATORS

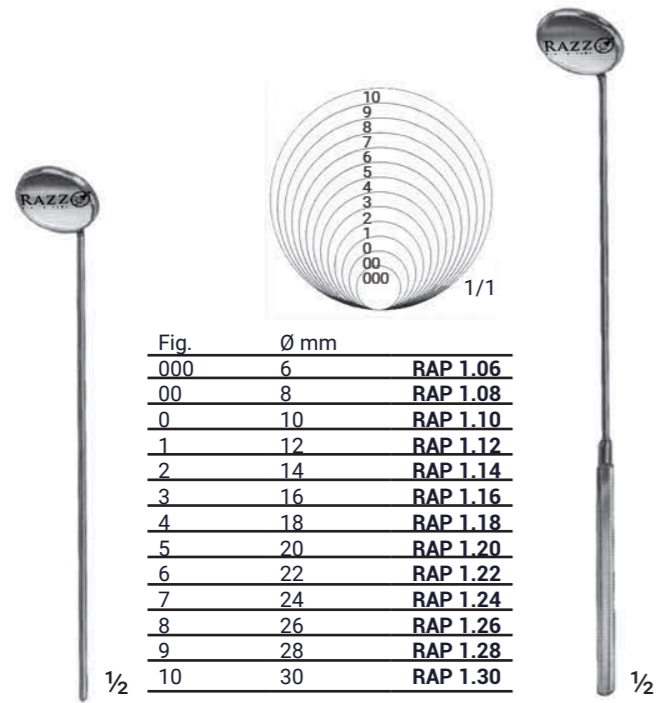

Fig.	Ø mm	
000	6	RAP 1.06
00	8	RAP 1.08
0	10	RAP 1.10
1	12	RAP 1.12
2	14	RAP 1.14
3	16	RAP 1.16
4	18	RAP 1.18
5	20	RAP 1.20
6	22	RAP 1.22
7	24	RAP 1.24
8	26	RAP 1.26
9	28	RAP 1.28
10	30	RAP 1.30

Laryngeal Mirror with Handle

RAP 01.06 - RAP 01.30
220mm/8 3/4"

RAP 01.50
Handle For Laryngeal Mirror
with adjustable Screw



BECKMAN
RAP 05.11 BECKMAN
RAP 05.16 RAP 05.21
220mm/8 3/4" 220mm/8 3/4"

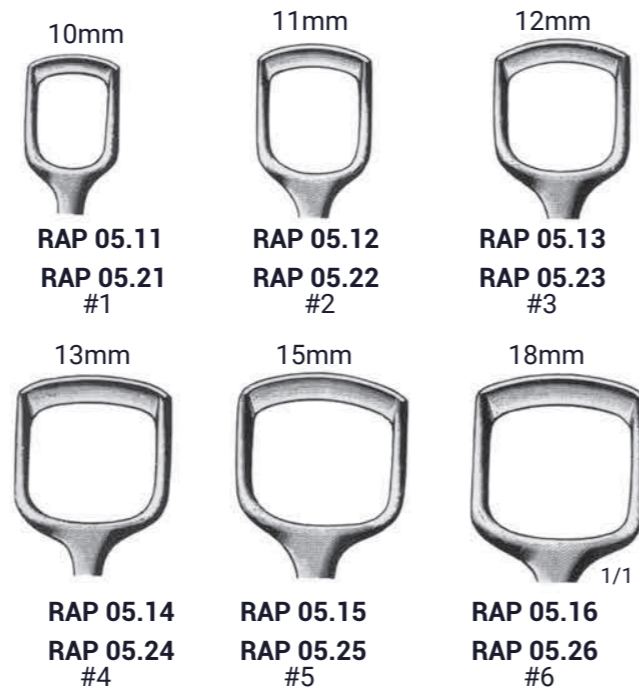

10mm 11mm 12mm
RAP 05.11 RAP 05.12 RAP 05.13
RAP 05.21 RAP 05.22 RAP 05.23
#1 #2 #3
13mm 15mm 18mm
RAP 05.14 RAP 05.15 RAP 05.16
RAP 05.24 RAP 05.25 RAP 05.26
#4 #5 #6

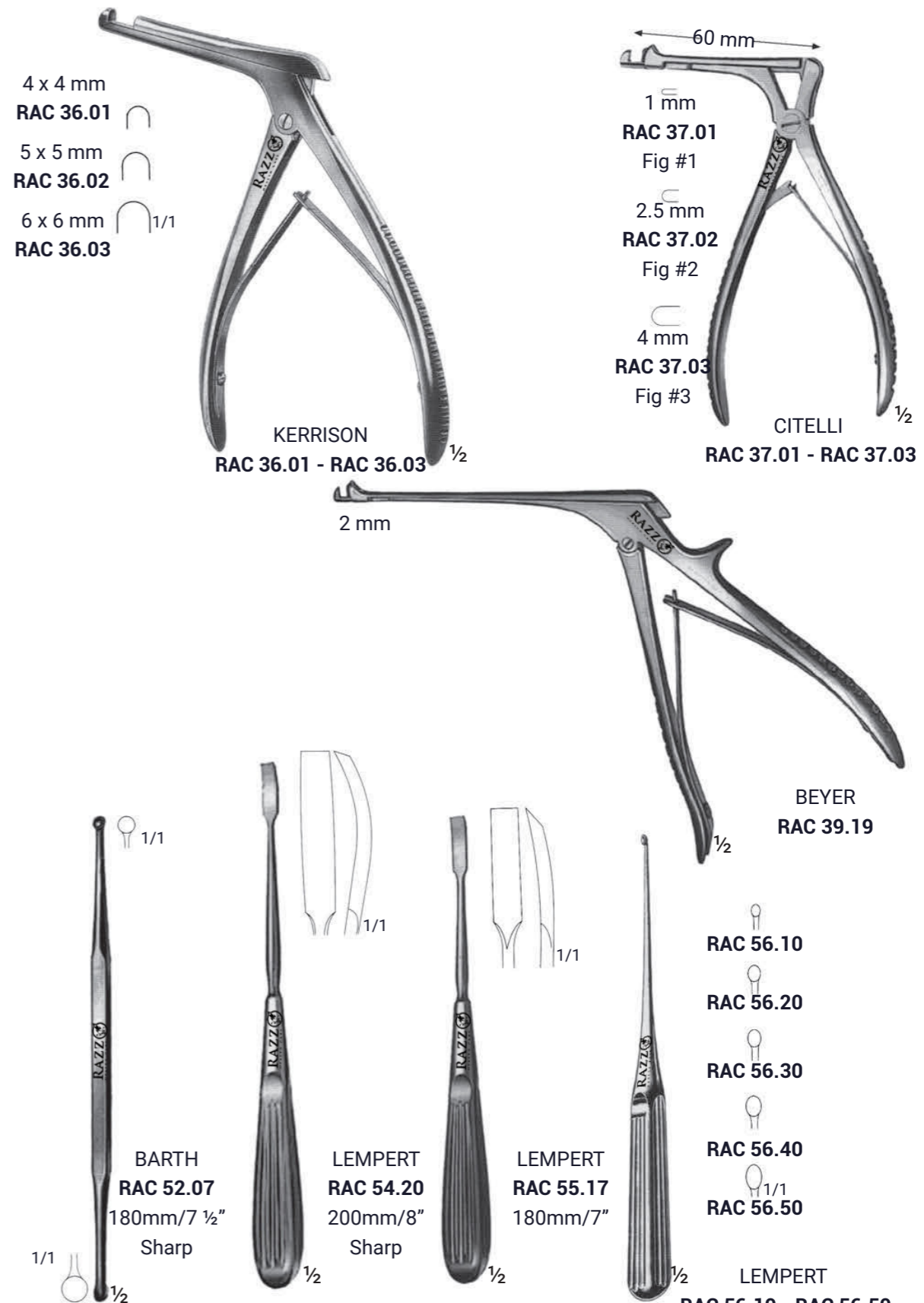

4 x 4 mm
RAC 36.01
5 x 5 mm
RAC 36.02
6 x 6 mm
RAC 36.03

KERRISON
RAC 36.01 - RAC 36.03

60 mm
1 mm
RAC 37.01
Fig #1
2.5 mm
RAC 37.02
Fig #2
4 mm
RAC 37.03
Fig #3
CITELLI
RAC 37.01 - RAC 37.03

2 mm
BEYER
RAC 39.19

1/1
BARTH
RAC 52.07
180mm/7 1/2"
Sharp

1/1
LEMPERT
RAC 54.20
200mm/8"
Sharp

1/1
LEMPERT
RAC 55.17
180mm/7"

RAC 56.10
RAC 56.20
RAC 56.30
RAC 56.40
RAC 56.50
LEMPERT
RAC 56.10 - RAC 56.50
175mm/7"

TRACHEAL TUBES, DILATORS & RECTRACTORS

EAR LOOPS & HOOKS



CHEVALIER - JACKSON
RAE 33.50 - RAE 33.69



LUER
RAE 33.80 - RAE 33.99



BILLEAU
RAC 71.10
RAC 71.30
165mm/6 1/4"



GROSS
RAC 72.35
120mm/4 3/4"
Blunt



LANGENBECK
RAC 75.13
130mm/5 1/4"



SHAPLEIGH
RAC 76.01
RAC 76.04
130mm/5 1/4"



MOLDENHAUER
RAC 77.16
130mm 5 1/4"



ZAUFAL
RAC 78.16
160mm/6 1/4"



TROUSSEAU
RAP 36.14 - 140mm/5 1/2"



LABORDE
RAP 37.14 - 140mm/ 5 1/2"



LUKENS
RAP 39.17
170mm/6 3/4"



JACKSON
RAP 40.17
170mm/6 3/4"



WAGENER
RAC 79.01 - RAC 79.07
165mm/6 1/2"



RAC 79.05 RAC 79.06 RAC 79.07

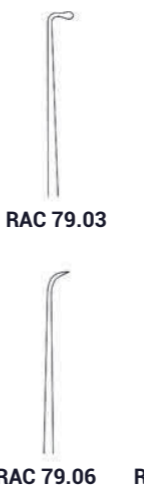

RAC 79.01 RAC 79.02 RAC 79.03 RAC 79.04



LUCAE
RAC 80.01 - RAC 80.03
140mm/5 1/2"



RAC 80.01 RAC 80.02 RAC 80.03



DAY
RAC 81.01 - RAC 81.02
160mm/6 1/4"



RAC 81.01 RAC 81.02

PARACENTESIS NEEDLES & EAR DRESSING FORCEPS

DRESSING AND POLYPUS FORCEPS

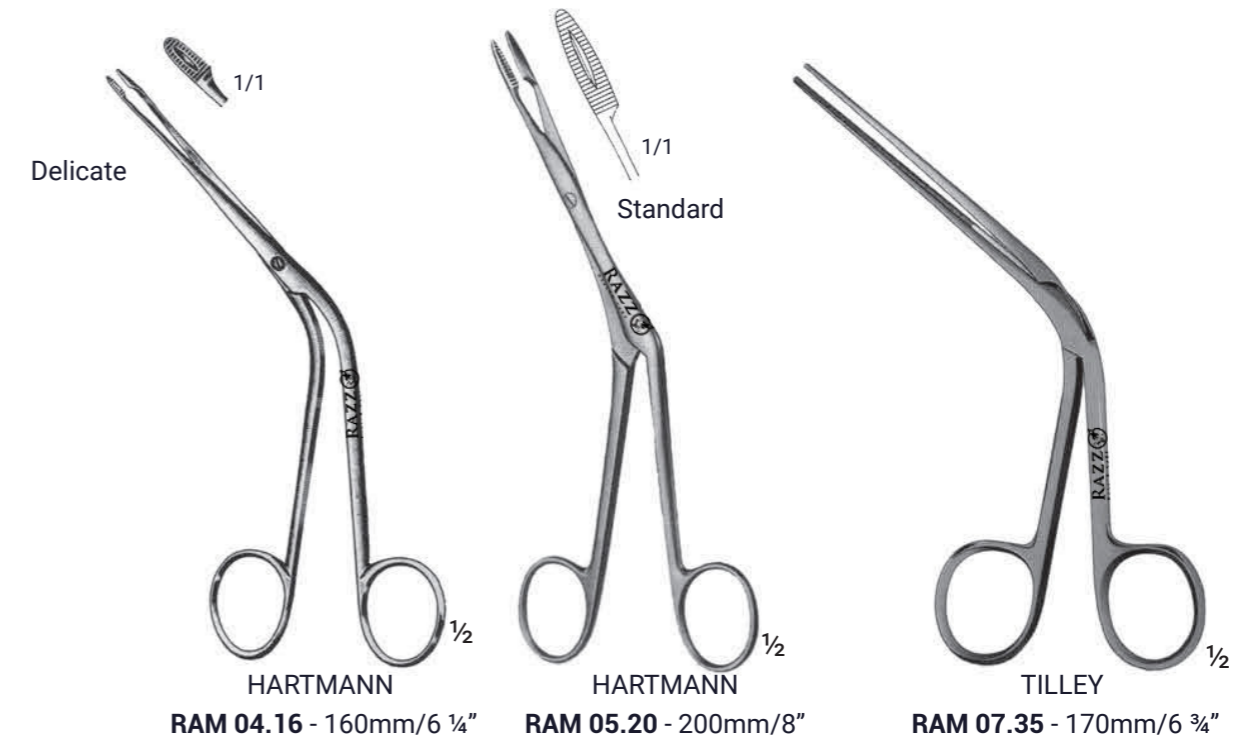
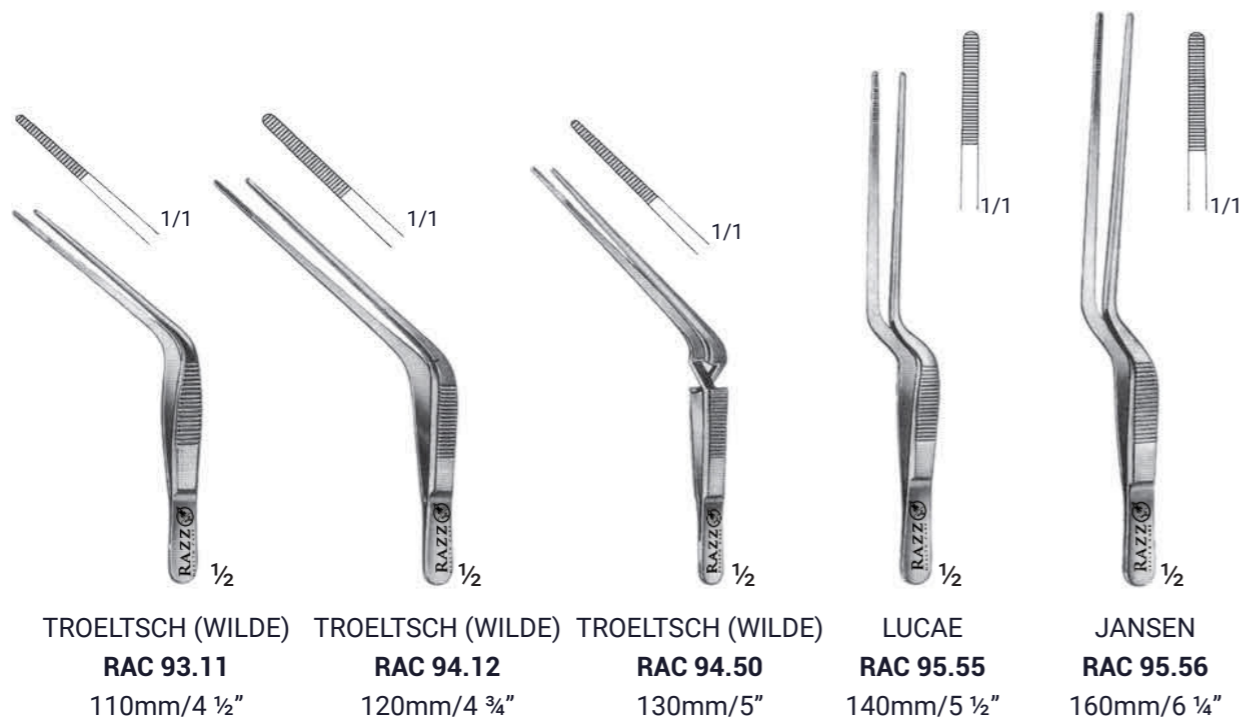
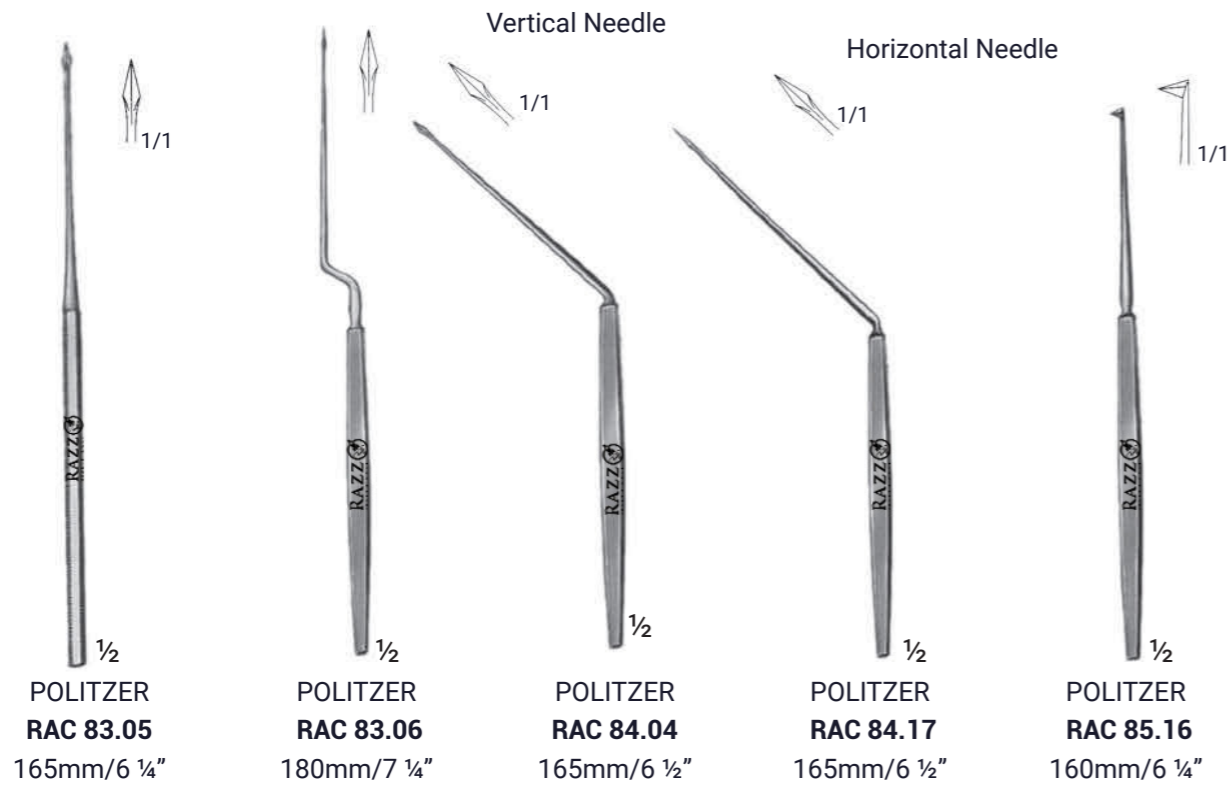

TONSIL SEIZING FORCEPS, SCISSORS, ENUCLEATORS & RETRACTORS

TONSIL SNARES & PUNCH FORCEPS

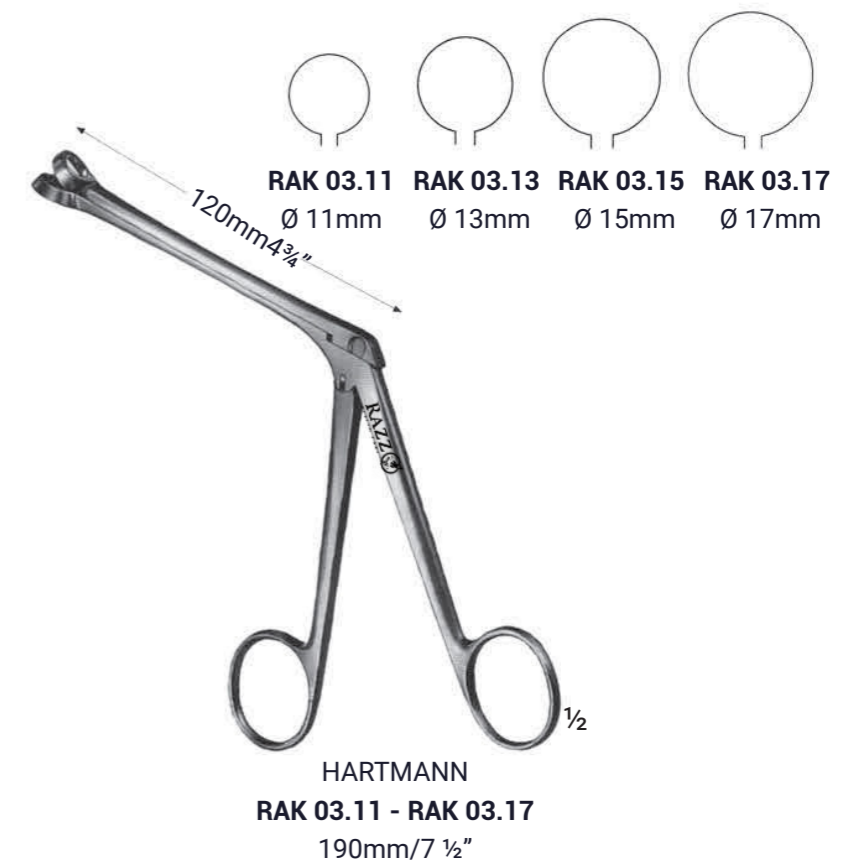
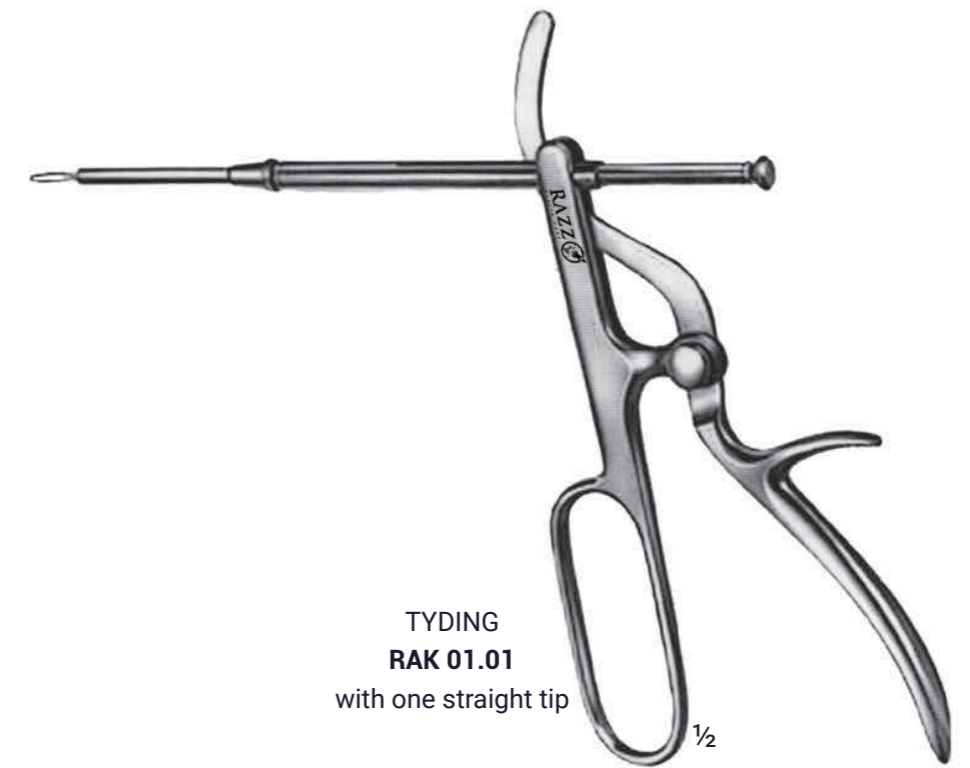
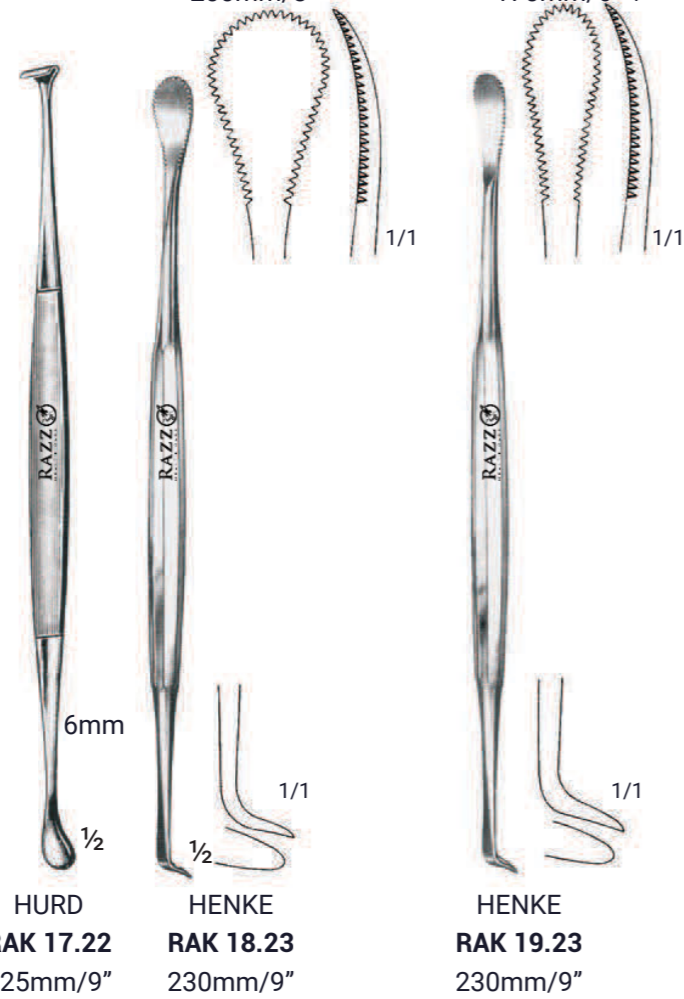

SEPTUM COMPRESSION FORCEPS, PUNCH FORCEPS & RHINOPLASTIC INSTRUMENTS

NASAL CUTTING FORCEPS



JANSEN MIDDLETON
RAM 49.19 - 190mm/7 1/2"

- 3mm
RAM 65.01
- 4mm
RAM 65.02
- 5mm
RAM 65.03
- 6mm
RAM 65.04



KERRISON
RAM 65.01 - RAM 65.04
200mm/8"



FOMON
RAN 01.15
150mm/6"

JOSEPH
RAN 08.15
150mm/6"

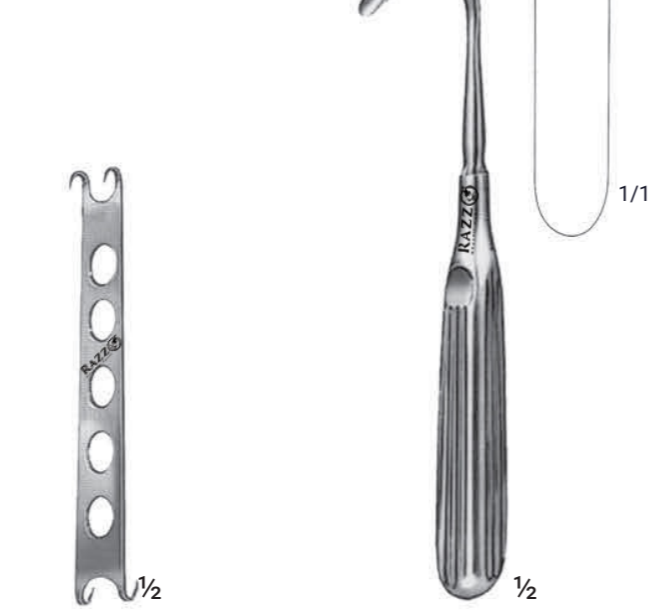

CONVERSE
RAN 09.12
120mm/4 3/4"

AUFRICHT
RAN 10.19
190mm/7 1/2"



RAM 44.01 RAM 44.02 RAM 44.03 RAM 44.04 RAM 44.05



RAM 44.10 RAM 44.11 RAM 44.12 RAM 44.13 RAM 44.14

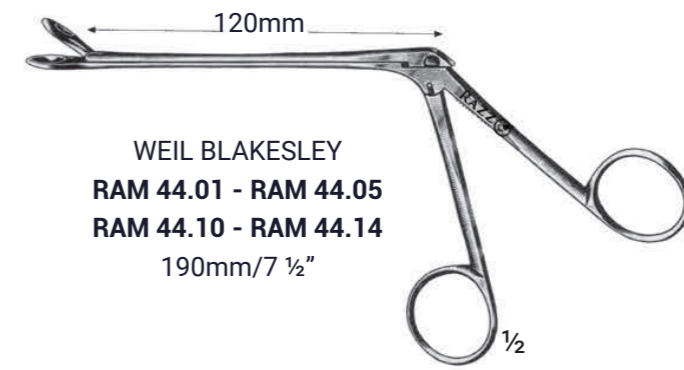

WEIL BLAKESLEY
RAM 44.01 - RAM 44.05
RAM 44.10 - RAM 44.14
190mm/7 1/2"

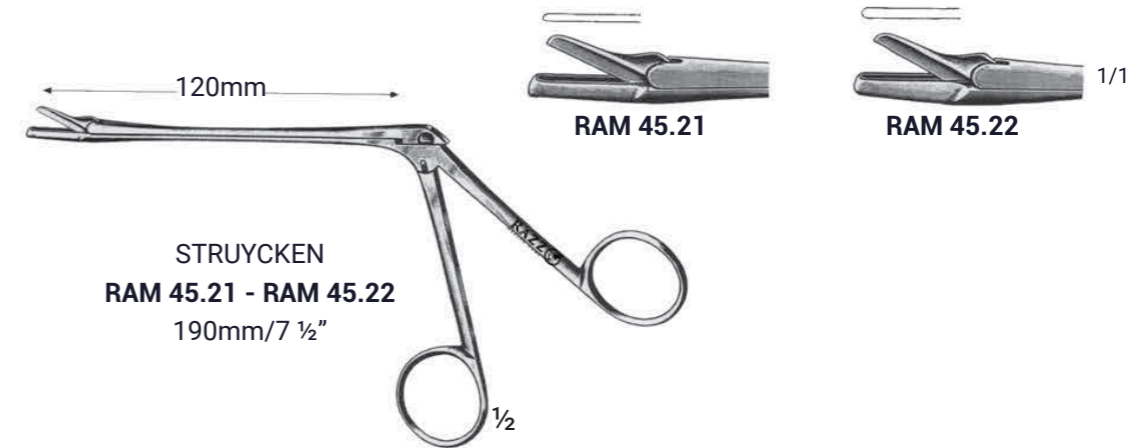

STRUYCKEN
RAM 45.21 - RAM 45.22
190mm/7 1/2"

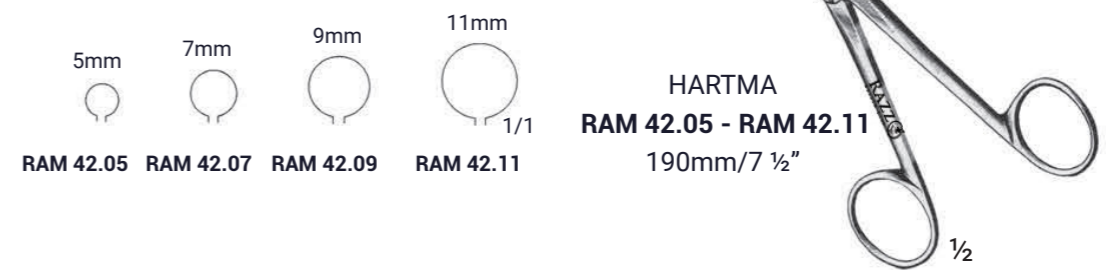

HARTMA
RAM 42.05 - RAM 42.11
190mm/7 1/2"

RHINOPLASTIC INSTRUMENTS

SEPTUM ELEVATORS & COMPRESSION FORCEPS

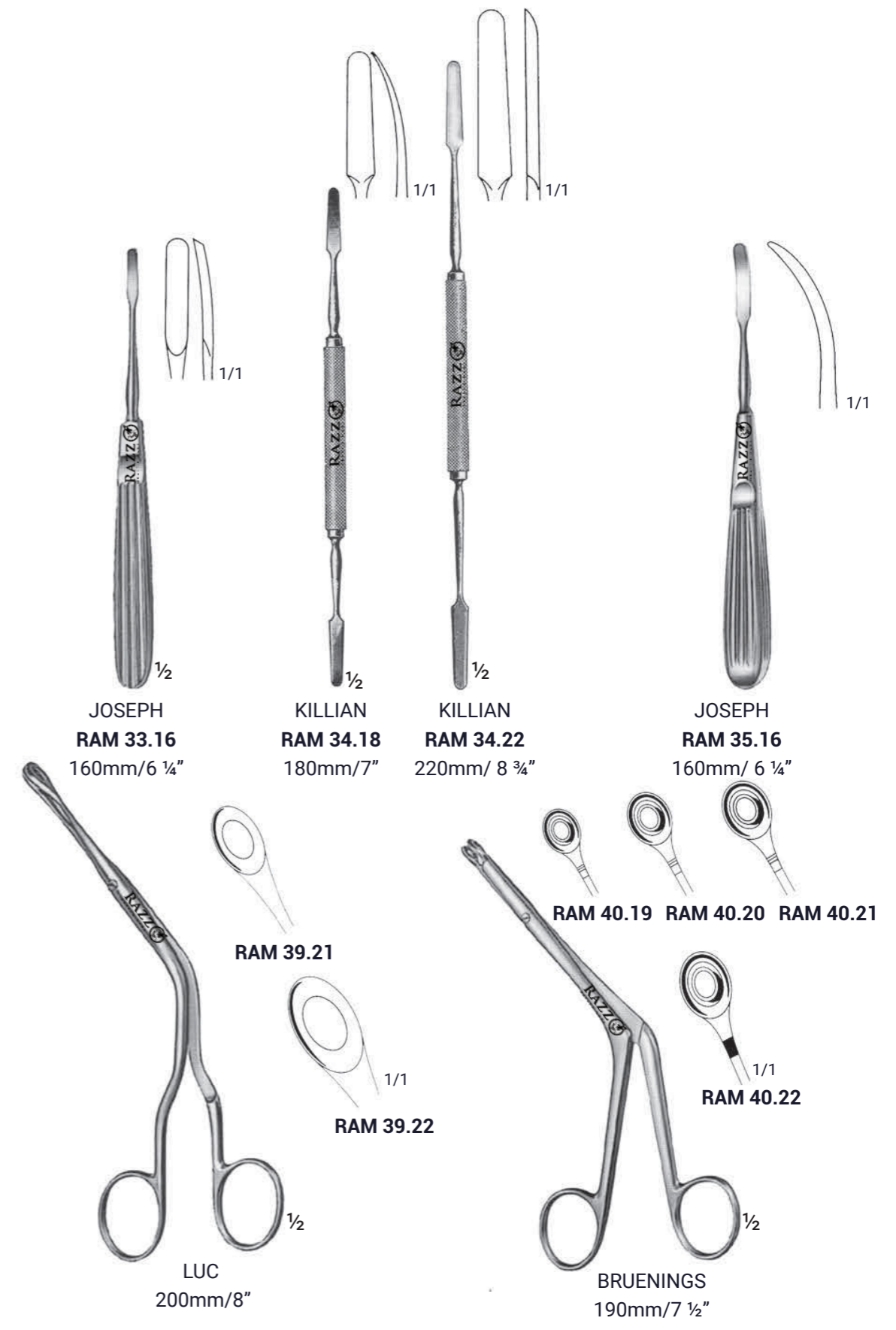
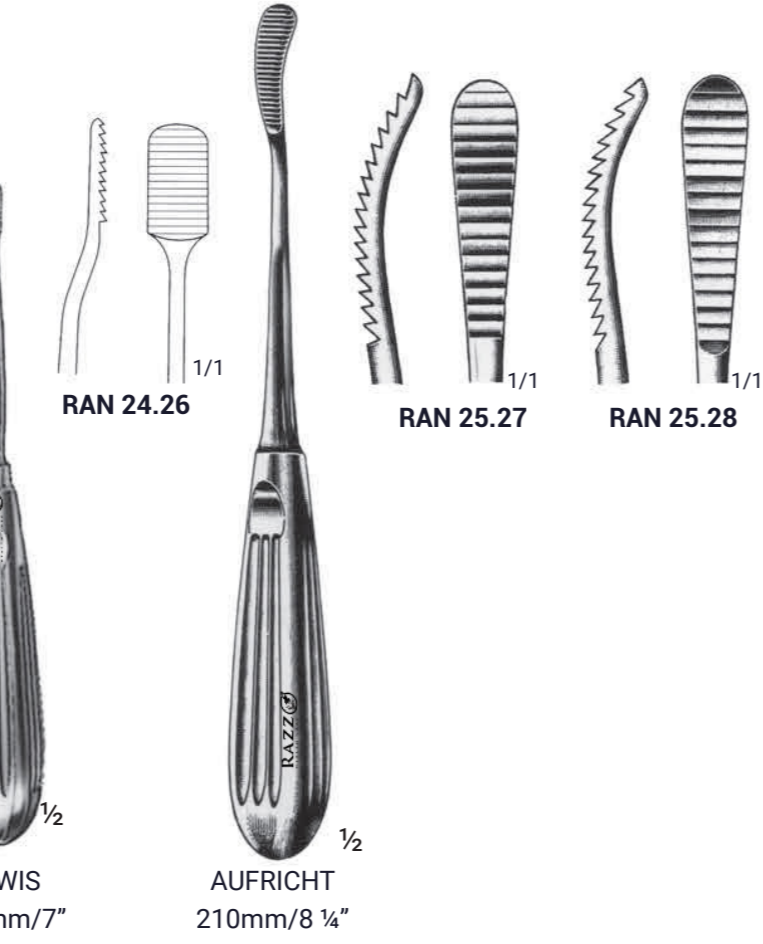
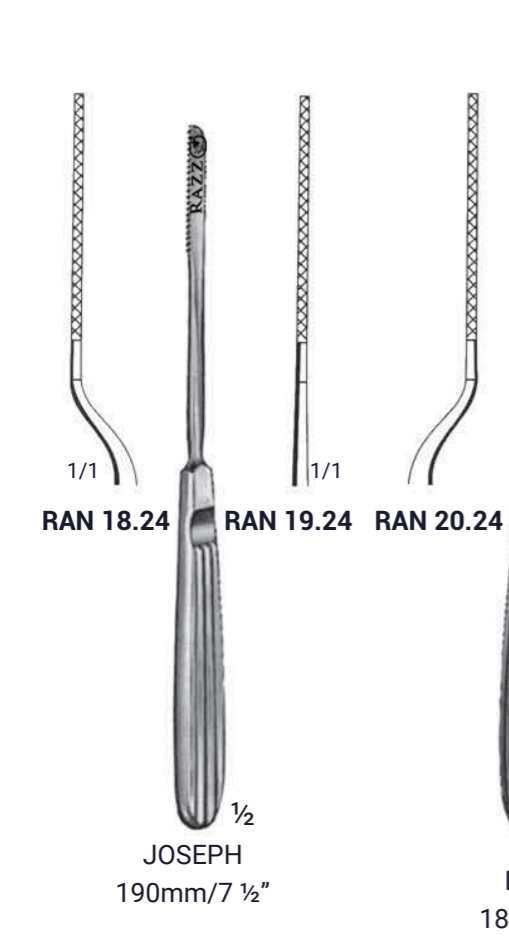
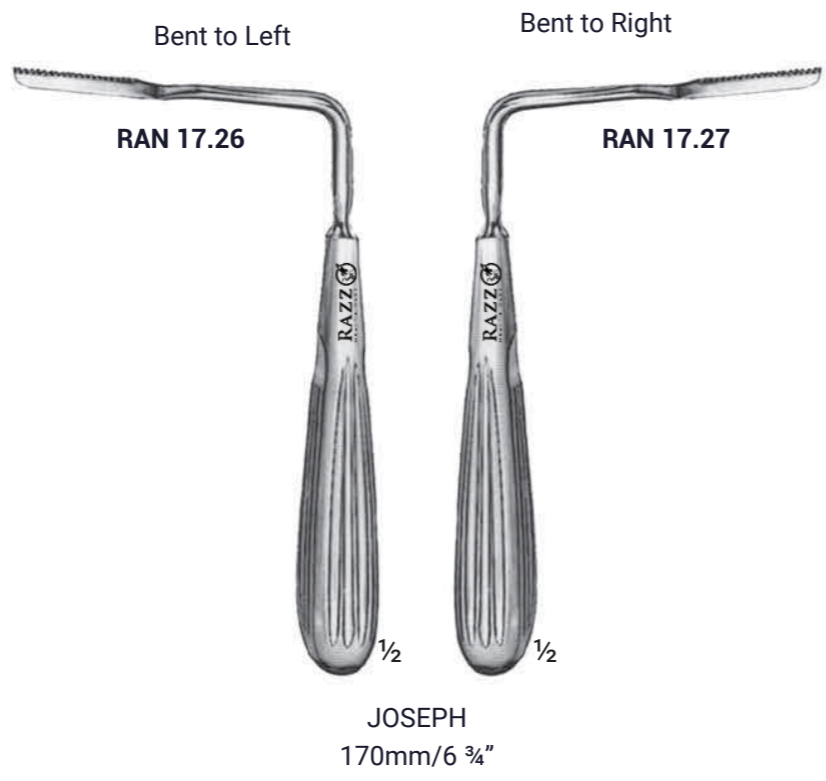
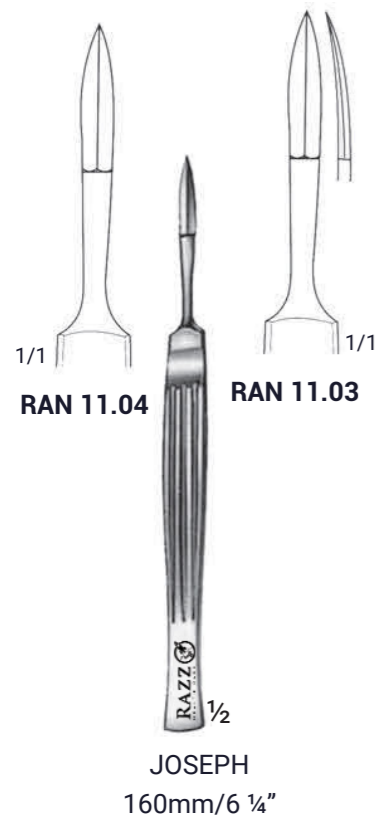

NASAL SCISSORS, SEPTUM KNIVES & SEPTUM ELEVATORS

MOUTH GAGS

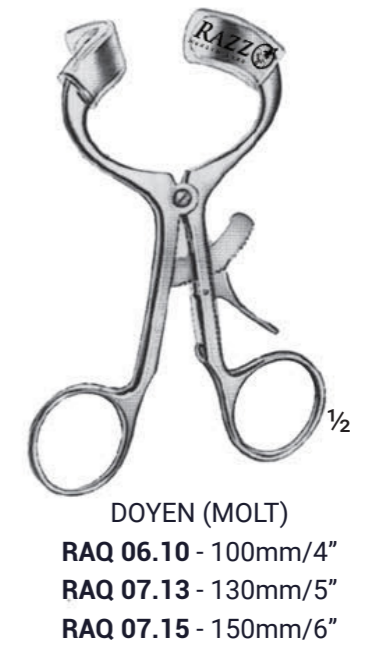
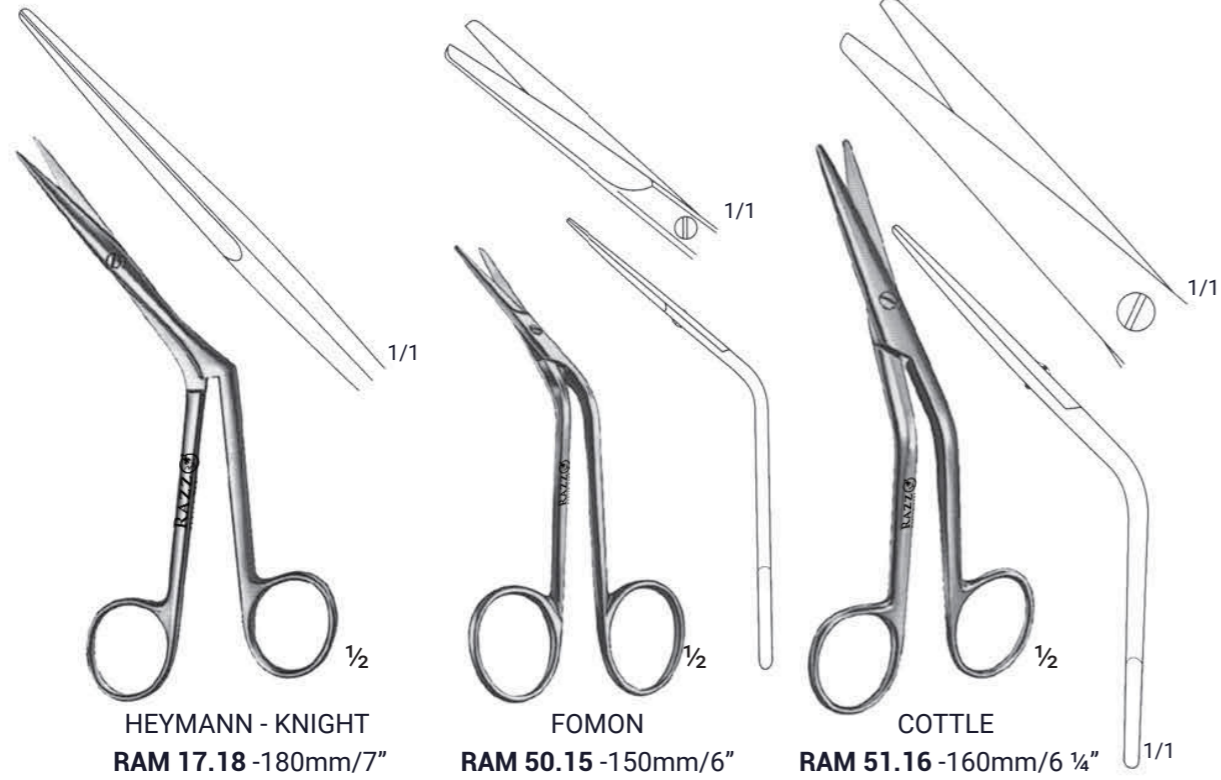

HEISTER
RAQ 05.05
 130mm/5"

DOYEN (MOLT)
RAQ 06.10 - 100mm/4"
RAQ 07.13 - 130mm/5"
RAQ 07.15 - 150mm/6"

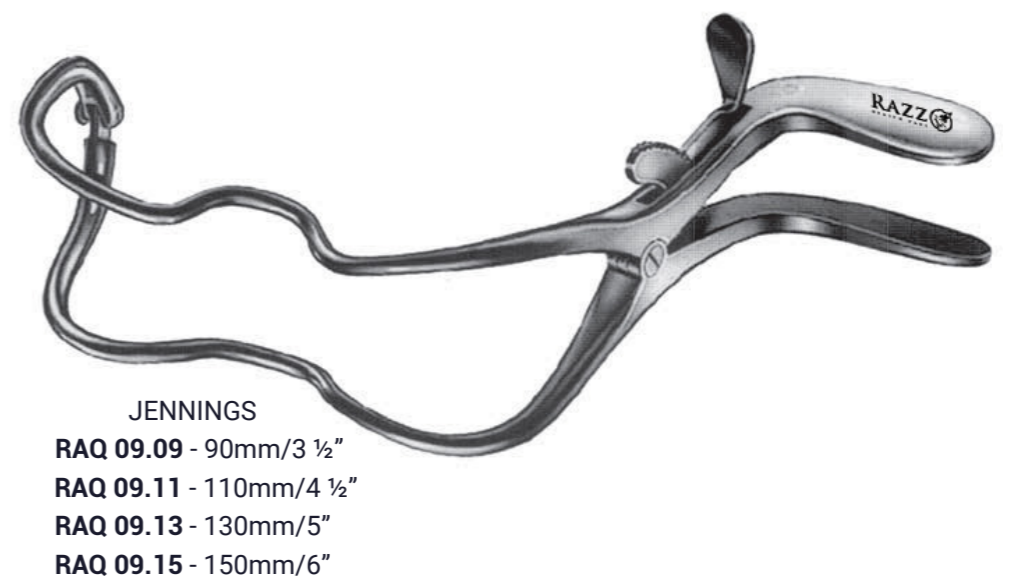
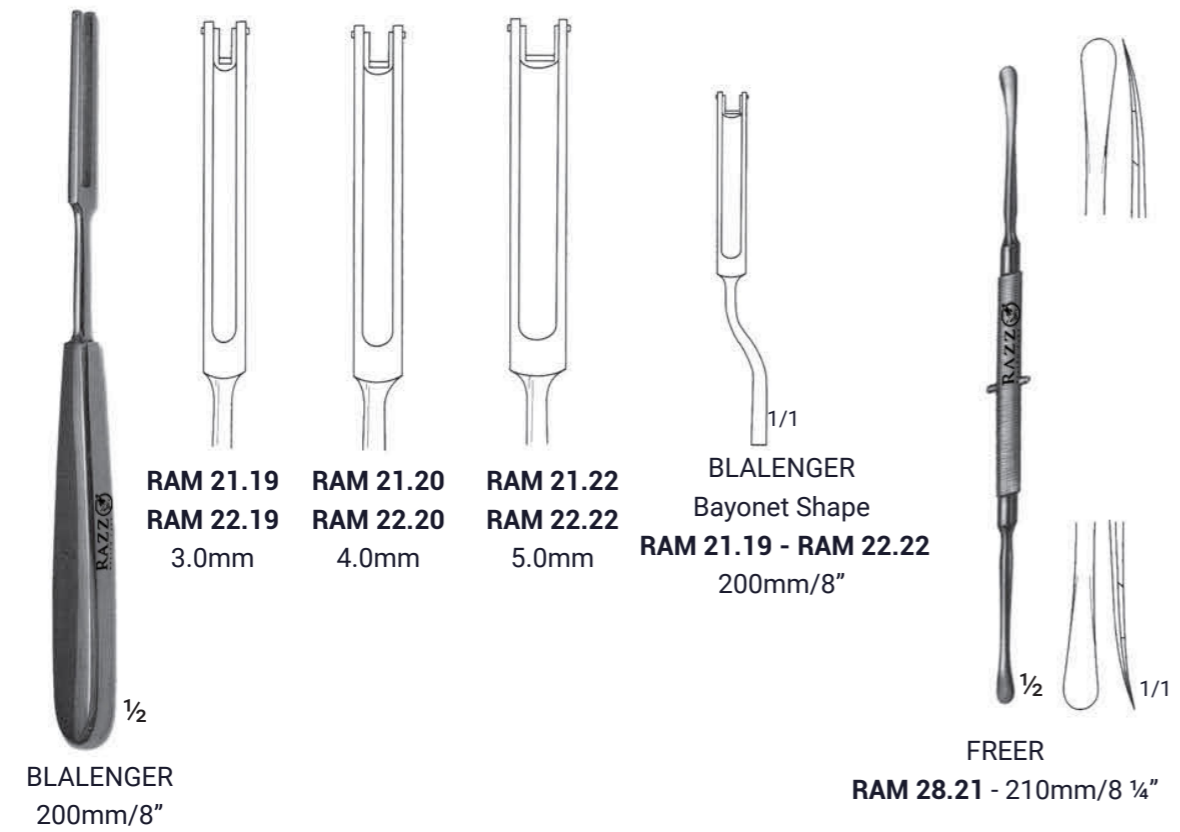

BLALENGER
 200mm/8"

BLALENGER
 Bayonet Shape
RAM 21.19 - RAM 22.22
 200mm/8"

FREER
RAM 28.21 - 210mm/8 1/4"

JENNINGS
RAQ 09.09 - 90mm/3 1/2"
RAQ 09.11 - 110mm/4 1/2"
RAQ 09.13 - 130mm/5"
RAQ 09.15 - 150mm/6"



ROSER - KONIG
 RAQ 13.45 - 160mm/6 1/4"
 RAQ 13.50 - 200mm/8"



DENHART
 RAQ 14.60 - 130mm/5"



DAVIS BOYLE
 RAQ 02.02
 Complete
 (1 Frame, 5 Tongue Depressors)



DINGMAN with 3 Blades
 RAQ 18.00



MCIVOR
 RAQ 07.00
 Complete
 (Frame, 3 Tongue Depressors)



TONGUE DEPRESSORS

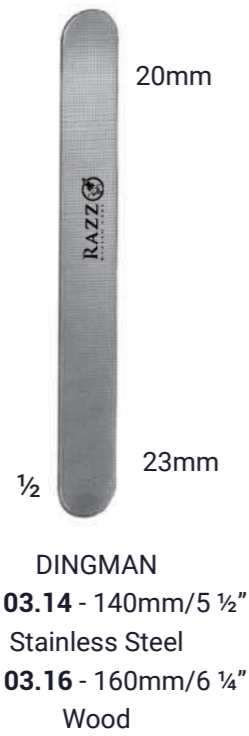

TONGUE HOLDING FORCEPS & CATHETER INTRODUCING FORCEPS

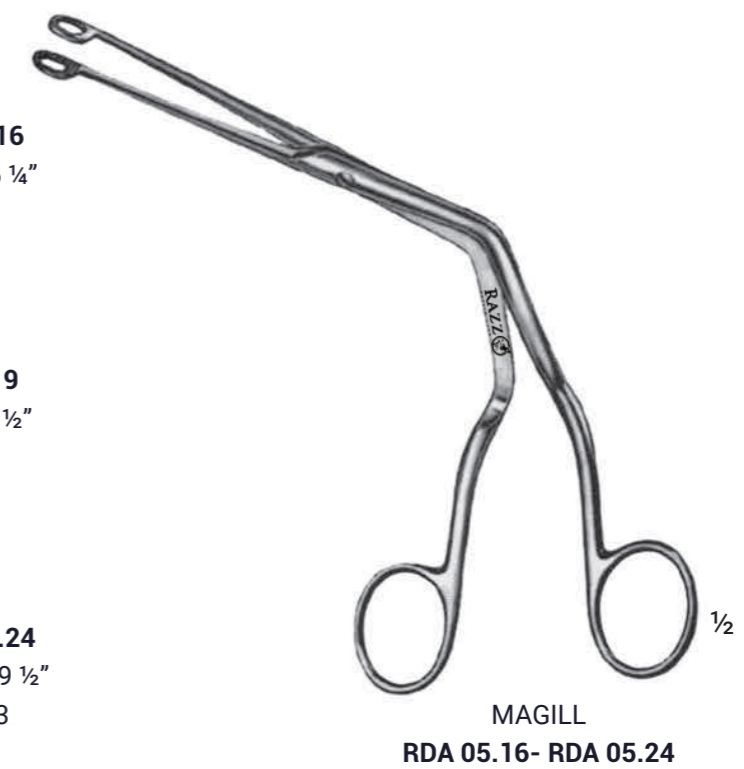
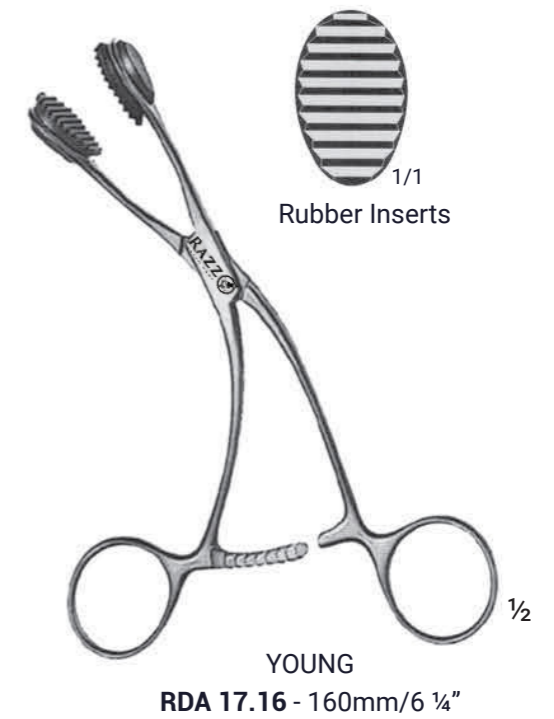

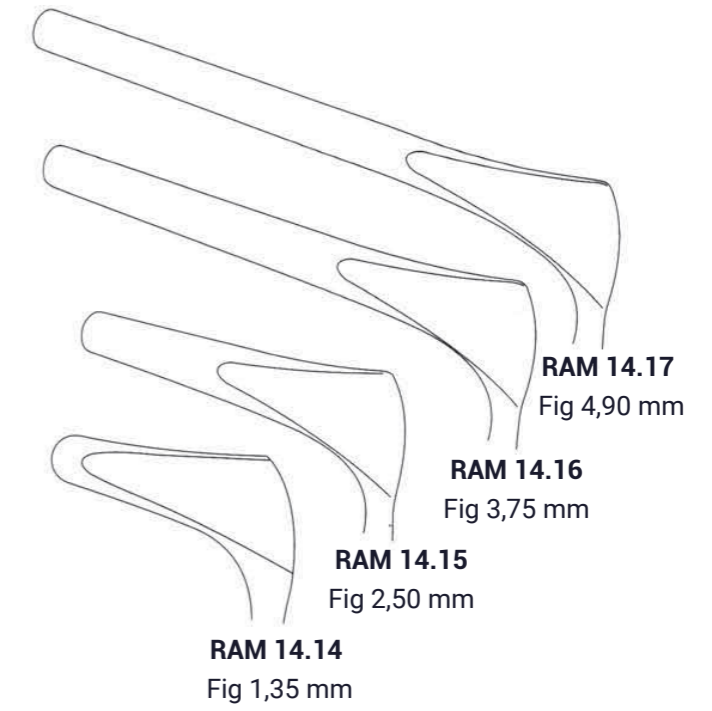

MICRO EAR FORCEPS

80mm

1/2

Smooth

4,0mm

0,8mm

Serrated

4,0mm

0,8mm

1/1

HARTMANN
RAC 13.01 - 13.09

Smooth

RAC 13.01
Straight
Serrated

RAC 13.06
Straight

RAC 13.07
Curved Up

RAC 13.08
Right

RAC 13.09
Left

Very Delicate

1/2

BELLUCI

4,0mm

0,8mm

1/1

RAC 14.01
Straight

RAC 14.02
Curved Up

RAC 14.03
Right

RAC 14.04
Left

1/2

Smooth

4,0mm

0,6mm

Smooth

RAC 13.10
Straight
4.0 x 0.6 mm

1/1

4,0mm

0,6mm

RAC 13.16 - 4.0 x 0.6 mm
Straight

3,0mm

0,6mm

RAC 13.17 - 3.0 x 0.6 mm
Curved

RAC 13.18 - 3.0 x 0.6 mm
Right

RAC 13.19 - 3.0 x 0.6 mm
Left

Serrated

HARTMANN
RAC 13.10 - 13.19

1,8mm

4,0mm

0,8mm

1,0mm

1/2

WULLSTEIN

RAC 15.01
Straight

RAC 15.02
Curved Up









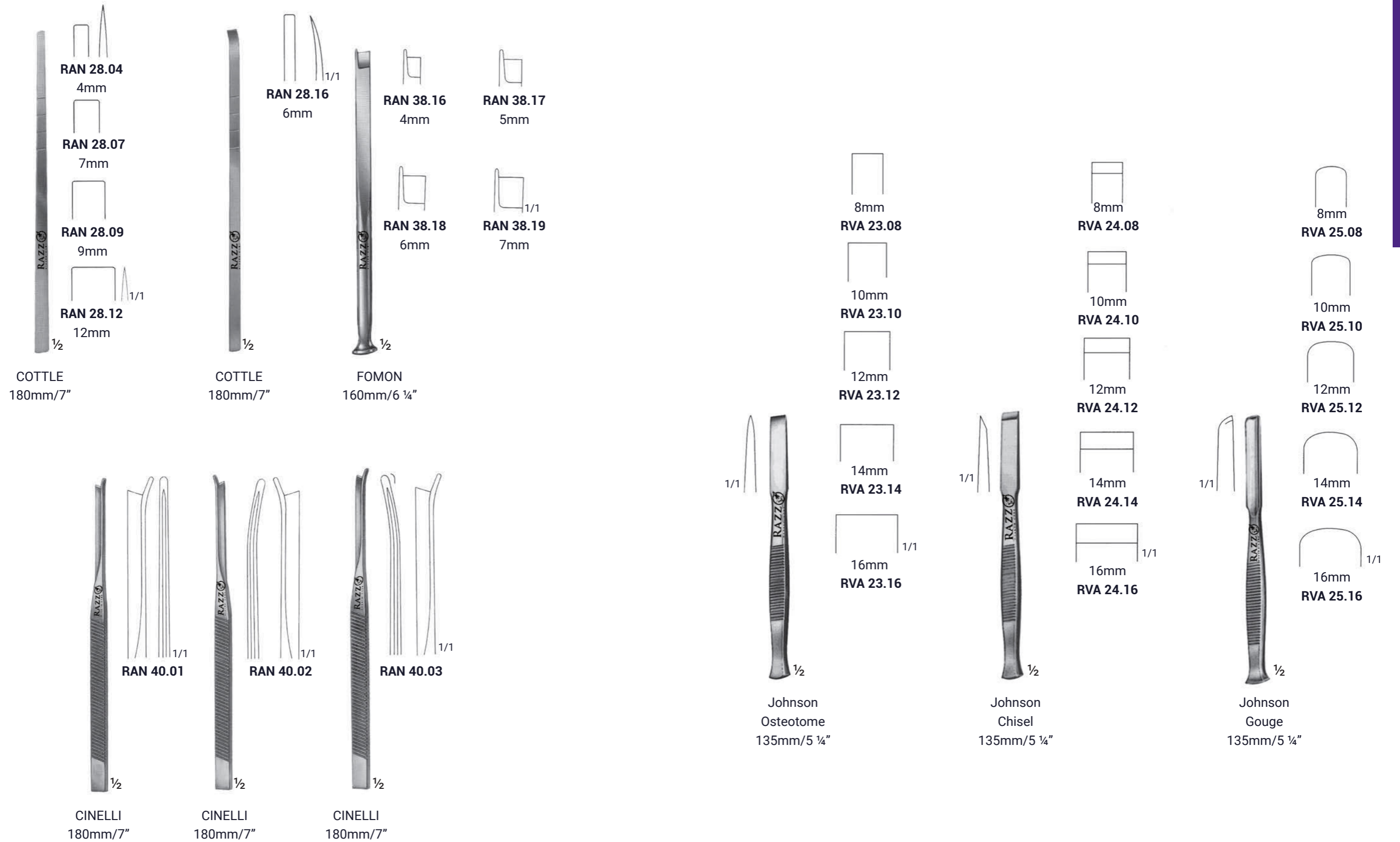



























RAC 15.03
Curved Up

RAC 15.04
Left

RHINOPLASTIC INSTRUMENTS

BONE CHISELS OSTEOTOME AND GOUGES



				 4mm RVA 17.04	 4mm RVA 18.04
135mm/5 1/4"	170mm/6 3/4"	135mm/5 1/4"	170mm/6 3/4"		
 2mm RVA 05.02	 2mm RVA 05.52	 2mm RVA 06.02	 2mm RVA 06.52	 6mm RVA 17.06	 6mm RVA 18.06
 3mm RVA 05.03	 3mm RVA 05.53	 3mm RVA 06.03	 3mm RVA 06.53	 8mm RVA 17.08	 8mm RVA 18.08
 4mm RVA 05.04	 4mm RVA 05.54	 4mm RVA 06.04	 4mm RVA 06.54	 10mm RVA 17.10	 10mm RVA 18.10
 5mm RVA 05.05	 5mm RVA 05.55	 5mm RVA 06.05	 5mm RVA 06.55	 12mm RVA 17.12	 12mm RVA 18.12
 6mm RVA 05.06	 6mm RVA 05.56	 6mm RVA 06.06	 5mm RVA 06.56	 14mm RVA 17.14	 14mm RVA 18.14
 PARTSCH Chisel 1/2	 PARTSCH Gouge 1/2			 ALEXANDER Chisel 180mm/7" 1/1	 ALEXANDER Gouge 180mm/7" 1/1

	 RAY 88.11 17 x 14 mm 195mm/7 3/4"
	 RAY 88.12 22 x 20 mm 205mm/8"
	 RAY 88.13 30 x 26 mm 230mm/9"
 MIDDELDORPF 1/2	

	 MIDDELDORPF 275mm/10 3/4" 1/2
--	---

 RAY 89.21 45 x 45 mm

 RAY 89.22 45 x 50 mm
--

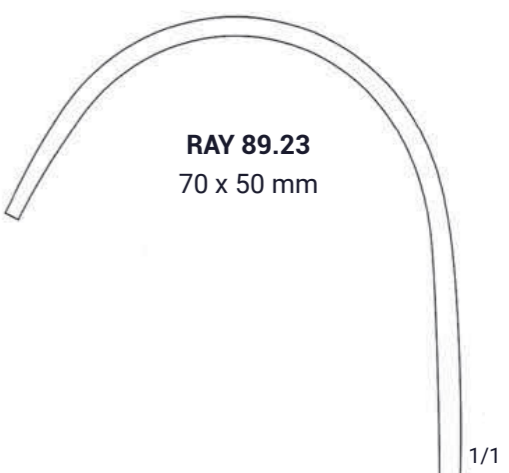
 RAY 89.23 70 x 50 mm 1/1
--

TISSUE FORCEPS



Ring Tissue Forceps

FIG	CAT NO.	RING Ø(mm)	
A	RRF 01.50	150	1,3 x 1,9
A	RRF 01.80	180	1,3 x 1,9
A	RRF 02.10	210	1,3 x 1,9
B	RRF 01.51	150	0,4 x 1,0
B	RRF 01.81	180	0,4 x 1,0
B	RRF 02.11	210	0,4 x 1,0

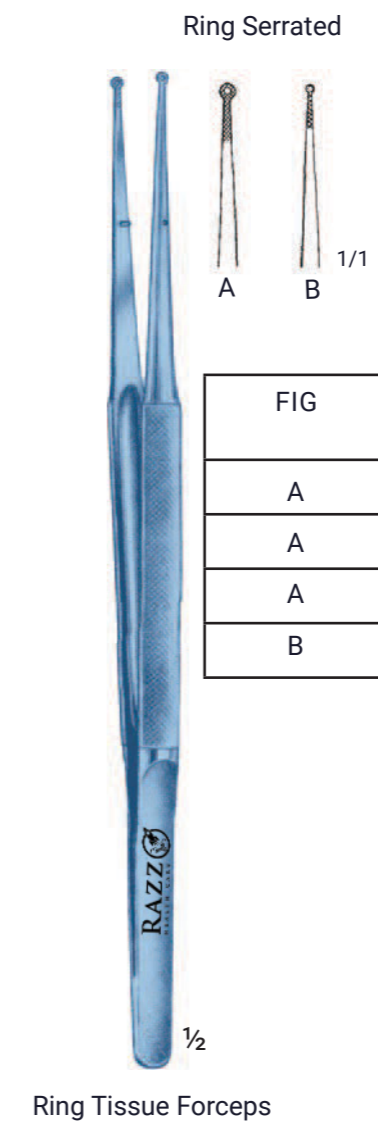

Ring Tissue Forceps

FIG	CAT NO.	RING Ø (mm)	
A	RRF 02.50	150	1,3 x 1,9
A	RRF 02.80	180	1,3 x 1,9
A	RRF 02.51	150	1,3 x 1,9
B	RRF 02.81	180	0,4 x 1,0

TITANIUM INSTRUMENTS

TISSUE FORCEPS

TISSUE FORCEPS

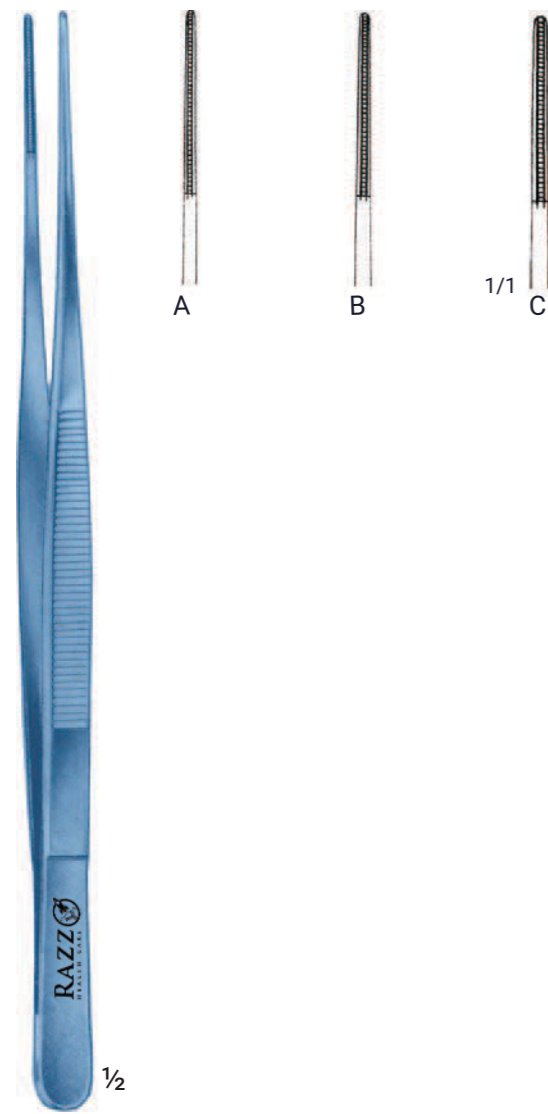

DeBakey Tissue Forceps Delicate

FIG	CAT NO.	LENGTH (mm)	JAW (mm)
A	RDF 01.50	150	1,0
A	RDF 02.00	200	1,0
A	RDF 02.40	240	1,0
B	RDF 01.51	150	1,5
B	RDF 01.81	200	1,5
B	RDF 02.01	240	1,5
C	RDF 02.41	150	1,8
C	RDF 01.60	200	1,8

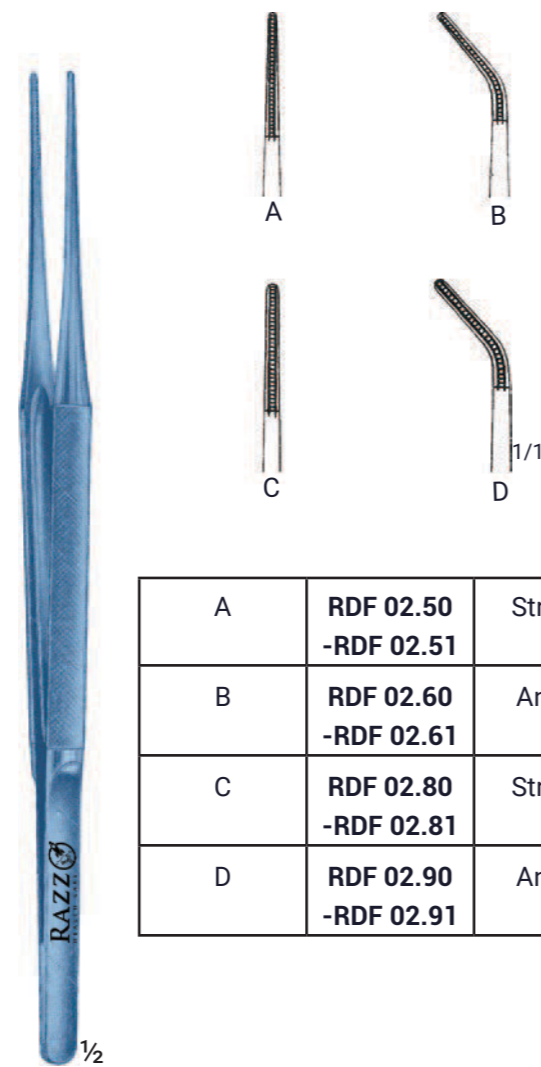

DeBakey Micro Tissue Forceps

A	RDF 02.50 -RDF 02.51	Straight	150mm
B	RDF 02.60 -RDF 02.61	Angled	150mm
C	RDF 02.80 -RDF 02.81	Straight	180mm
D	RDF 02.90 -RDF 02.91	Angled	180mm

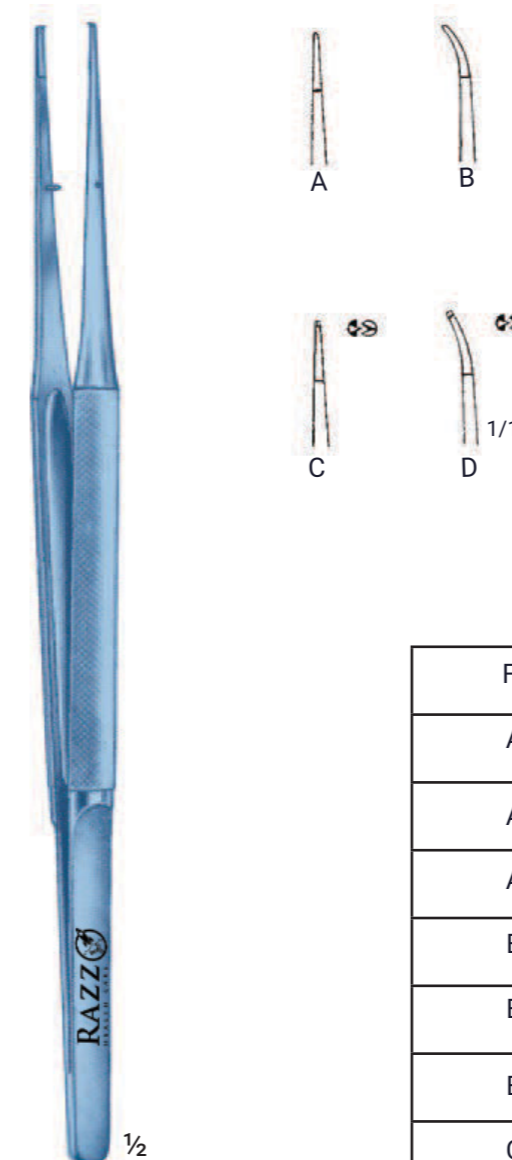

Tying Forceps

FIG	CAT NO.	LENGTH (mm)	JAW (mm)
A	RDF 10.01	150	-
A	RDF 10.02	180	-
A	RDF 10.03	210	-
B	RDF 10.04	150	-
B	RDF 10.05	180	-
B	RDF 10.06	210	-
C	RDF 10.07	150	1 x 2
C	RDF 10.08	180	1 x 2
C	RDF 10.09	210	1 x 2
D	RDF 10.10	150	1 x 2
D	RDF 10.11	180	1 x 2
D	RDF 10.12	210	1 x 2

MICRO SCISSORS

NEEDLE HOLDERS



Micro Scissor
RMC 01.80 -180mm/7"
RMC 02.10 -210mm/8 1/4"
RMC 02.40 -240mm/9 1/2"



Micro Scissor
RMC 01.81 -180mm/7"
RMC 02.11 -210mm/8 1/4"
RMC 02.41 -230mm/9 1/2"

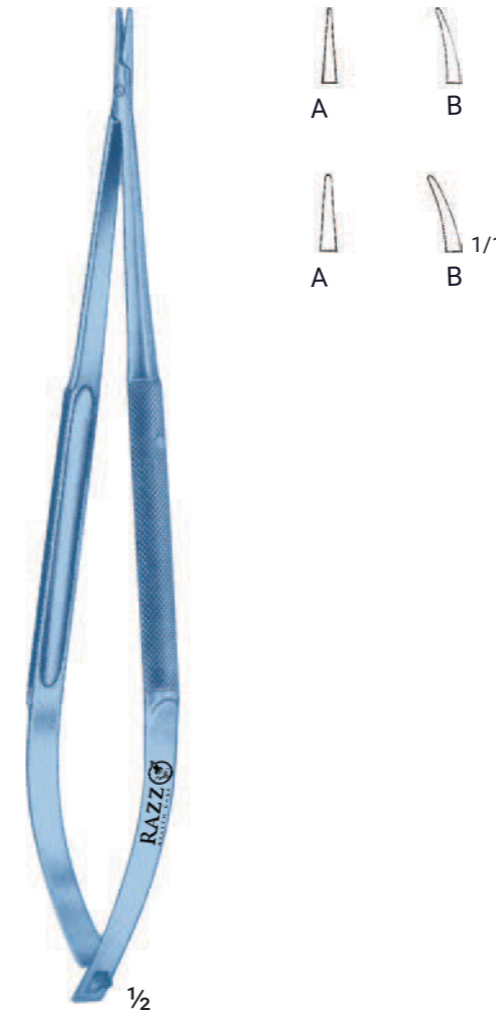

Micro Needle Holder
 without catch

FIG	LENGTH (mm)	CAT NO.
A	150	RMC 01.62
B	150	RMC 02.72
A	180	RMC 02.92
B	180	RMC 02.51
A	210	RMC 02.82
B	210	RMC 02.93

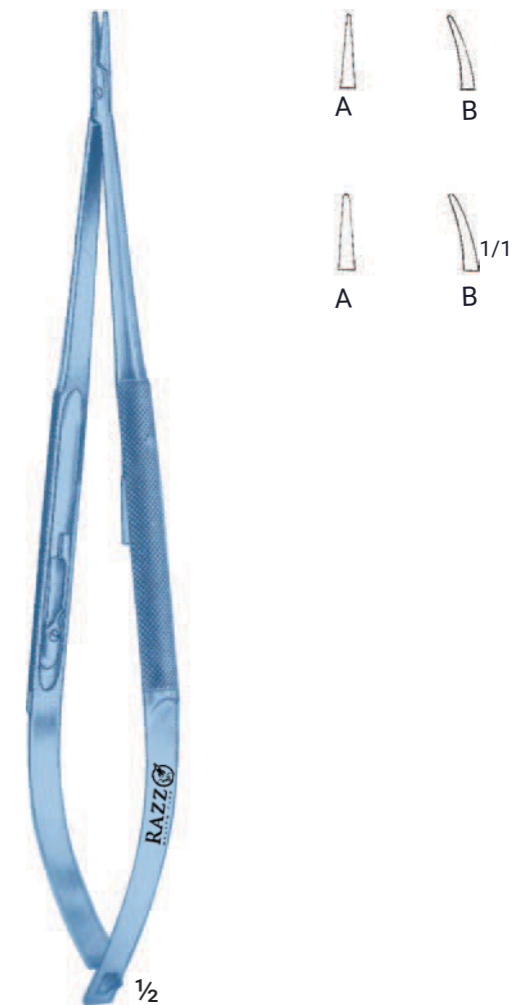

Micro Needle Holder
 with catch

FIG	LENGTH (mm)	CAT NO.
A	150	RMC 01.60
B	150	RMC 01.70
A	180	RMC 02.20
B	180	RMC 01.61
A	210	RMC 01.91
B	210	RMC 02.21

NEEDLE HOLDERS

MICRO SCISSORS



Coronary Needle Holder
without catch

FIG	LENGTH (mm)	CAT NO.
A	180	RNH 03.10
B	180	RNH 04.10
A	210	RNH 03.11
B	210	RNH 04.10

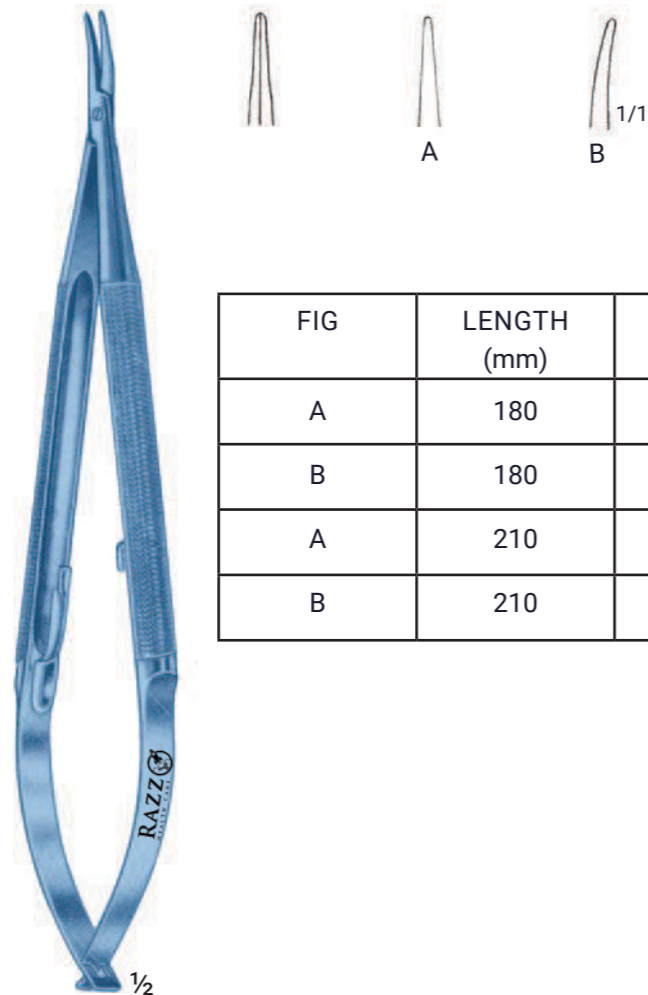

Coronary Needle Holder
with catch

FIG	LENGTH (mm)	CAT NO.
A	180	RNH 04.50
B	180	RNH 04.51
A	210	RNH 04.60
B	210	RNH 04.61

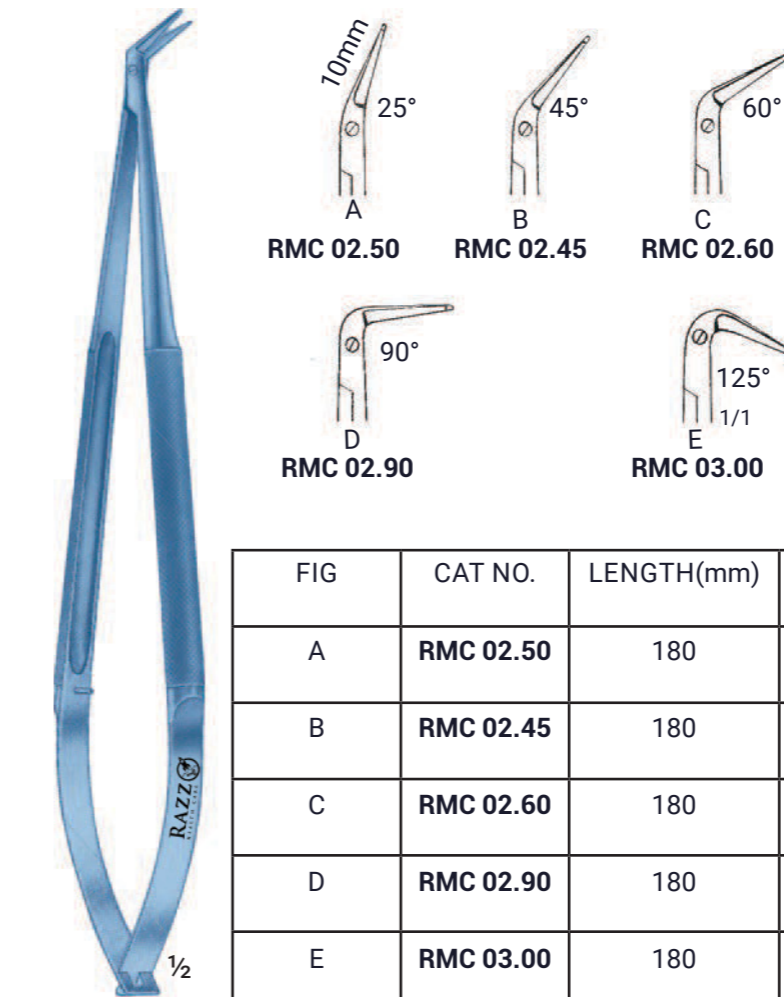

Coronary Artery Scissor

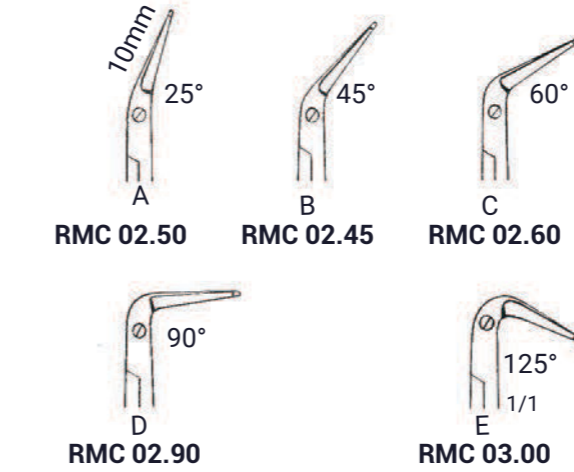
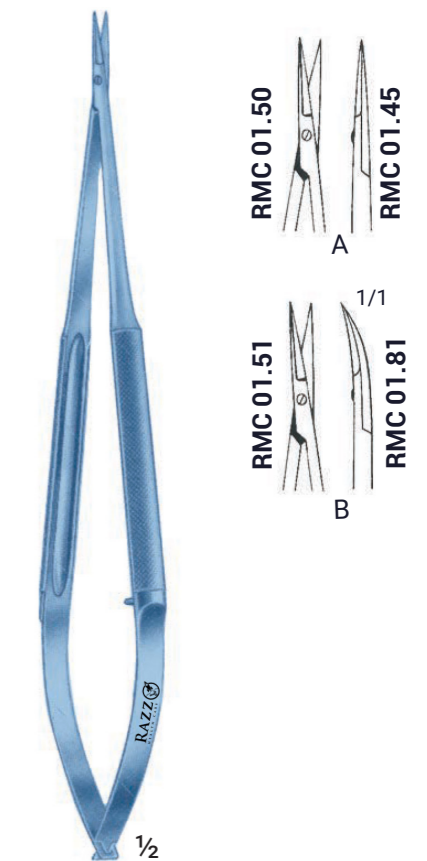
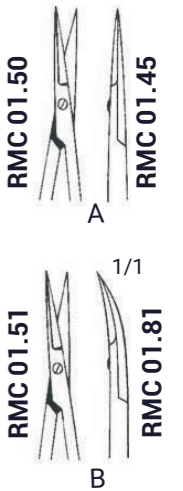

FIG	CAT NO.	LENGTH(mm)	DEG
A	RMC 02.50	180	25°
B	RMC 02.45	180	45°
C	RMC 02.60	180	60°
D	RMC 02.90	180	90°
E	RMC 03.00	180	125°

FIG	LENGTH(mm)	CAT NO.
A	150	RMC 01.50
B	150	RMC 01.45
A	180	RMC 01.51
B	180	RMC 01.81



Micro Scissor



NON -TRAUMATIC FORCEPS

NON -TRAUMATIC FORCEPS

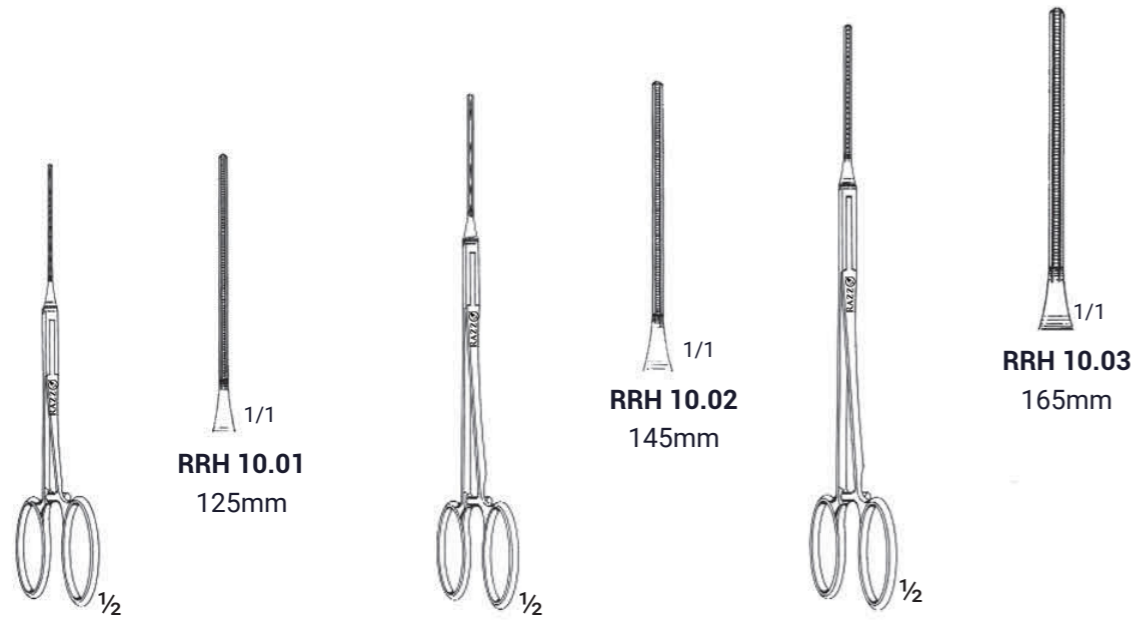

Straight Handle, Straight Jaws

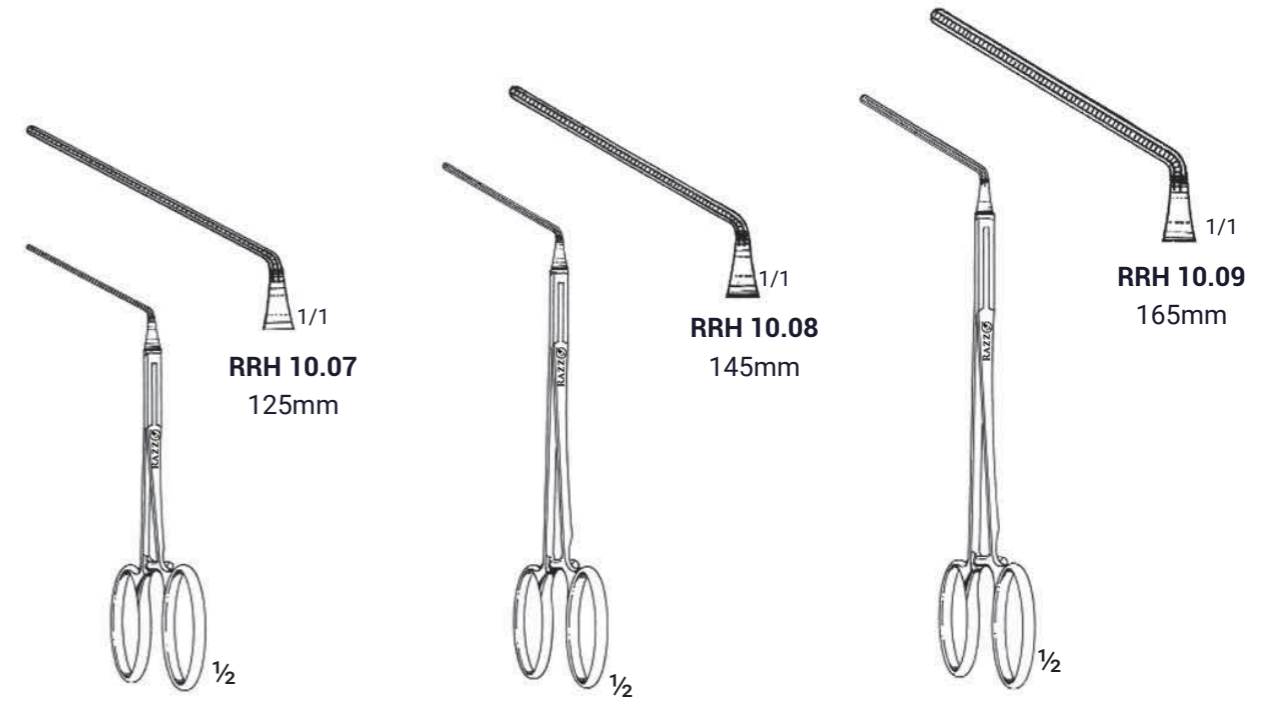

Straight Handle, Angled Jaws



Angled Handle, Straight Jaws

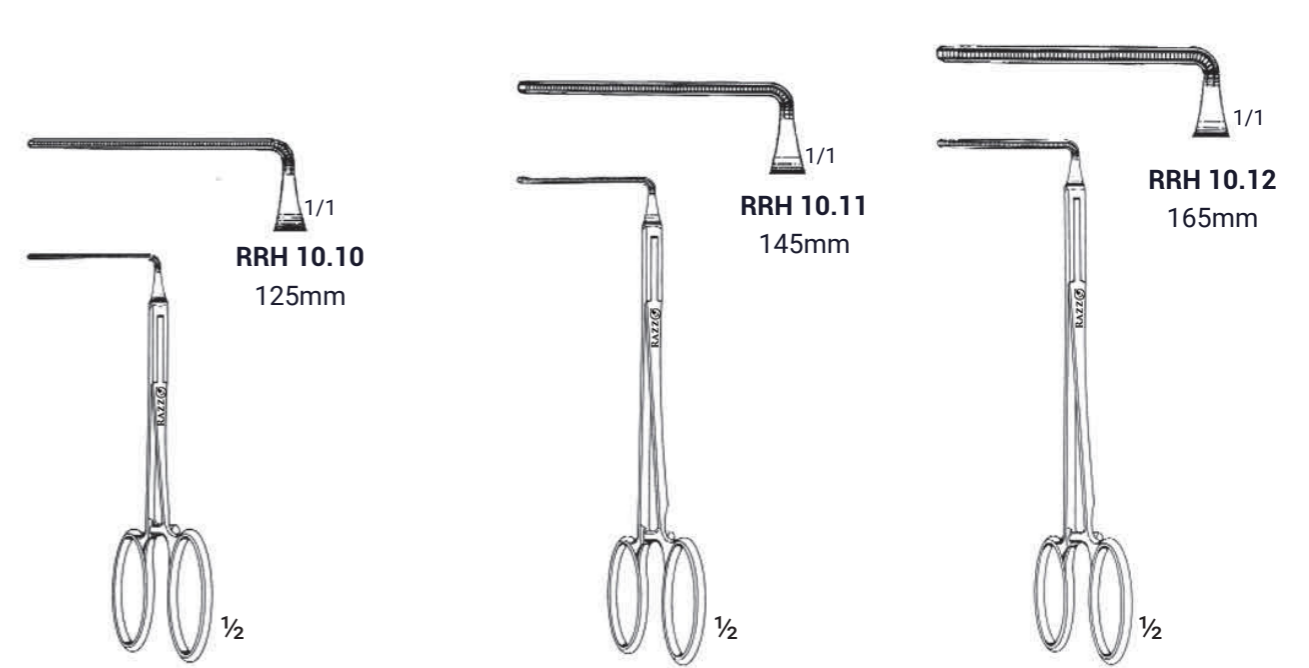

Straight Handle, Angled Jaws

NON-TRAUMATIC FORCEPS

DEBAKEY MICRO CLAMPS

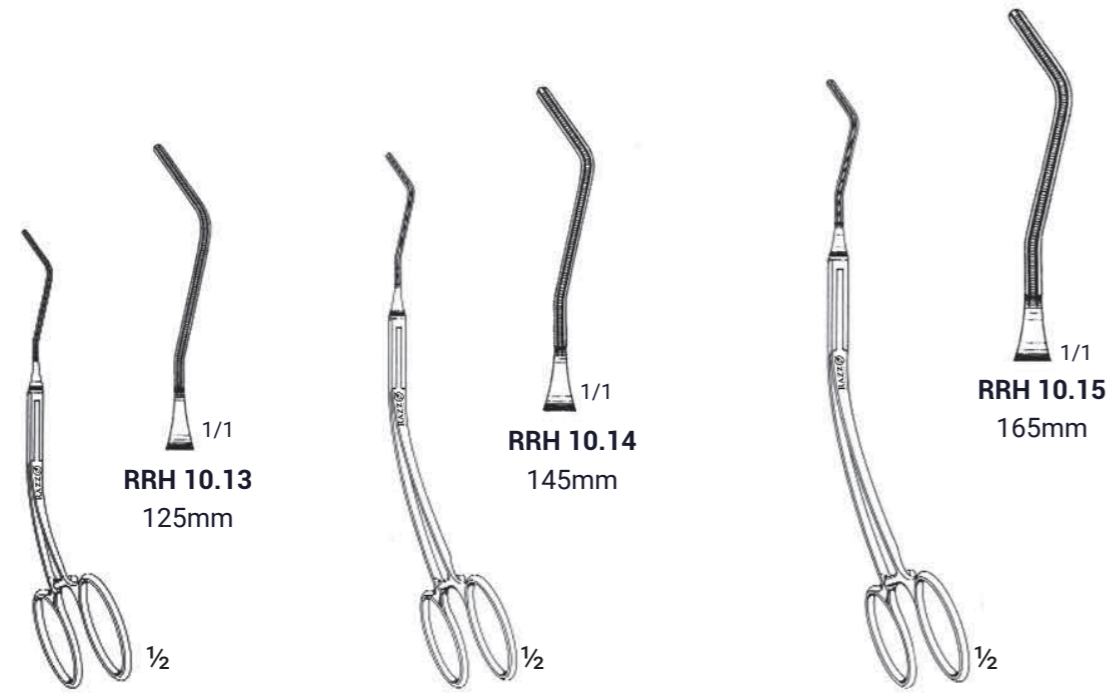

Curved Handle, Angled Jaws

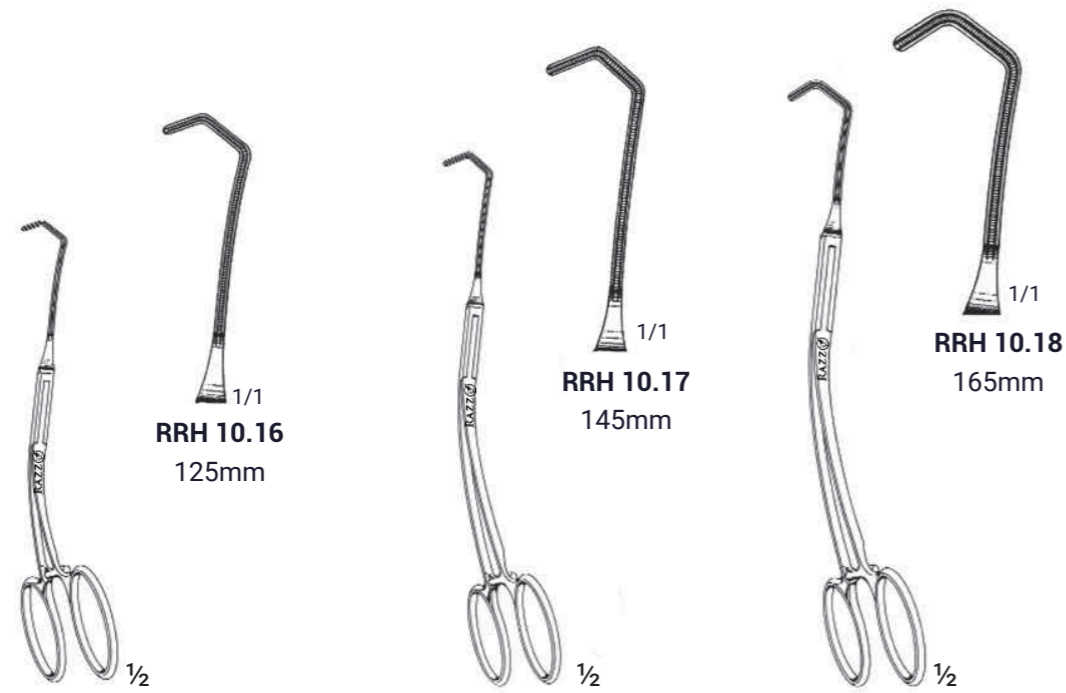

Curved Handle, Angled Jaws



Debakey

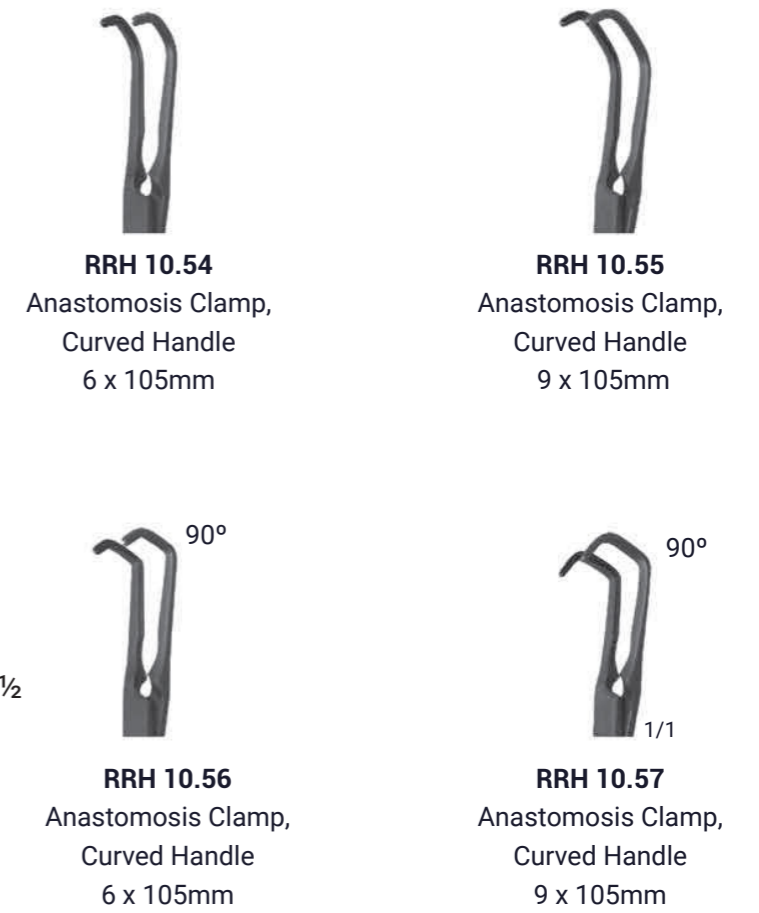

INSTRUMENT BOXES

Style A



	L	W	D
RAF 21.46	165 x	90 x	35 mm
RAF 21.50	200 x	100 x	35 mm
RAF 21.51	200 x	100 x	50 mm
RAF 21.53	230 x	130 x	50 mm
RAF 21.56	260 x	150 x	50 mm
RAF 21.58	280 x	140 x	60 mm
RAF 21.60	300 x	200 x	50 mm

Style B



	L	W	D
RAF 23.46	165 x	90 x	35 mm
RAF 23.50	200 x	100 x	35 mm
RAF 23.51	200 x	100 x	50 mm
RAF 23.53	230 x	130 x	50 mm
RAF 23.56	260 x	150 x	50 mm
RAF 23.58	280 x	140 x	60 mm
RAF 23.60	300 x	200 x	50 mm

Style C



	L	W	D
RAF 22.46	165 x	90 x	35 mm
RAF 22.48	180 x	80 x	50 mm
RAF 22.50	200 x	100 x	35 mm
RAF 22.51	200 x	100 x	50 mm
RAF 22.53	230 x	130 x	50 mm
RAF 22.55	250 x	120 x	60 mm
RAF 22.56	260 x	180 x	50 mm
RAF 22.58	280 x	140 x	60 mm
RAF 22.60	300 x	200 x	50 mm
RAF 22.62	320 x	150 x	60 mm
RAF 22.66	360 x	160 x	70 mm

L = Length W = Width D = Depth

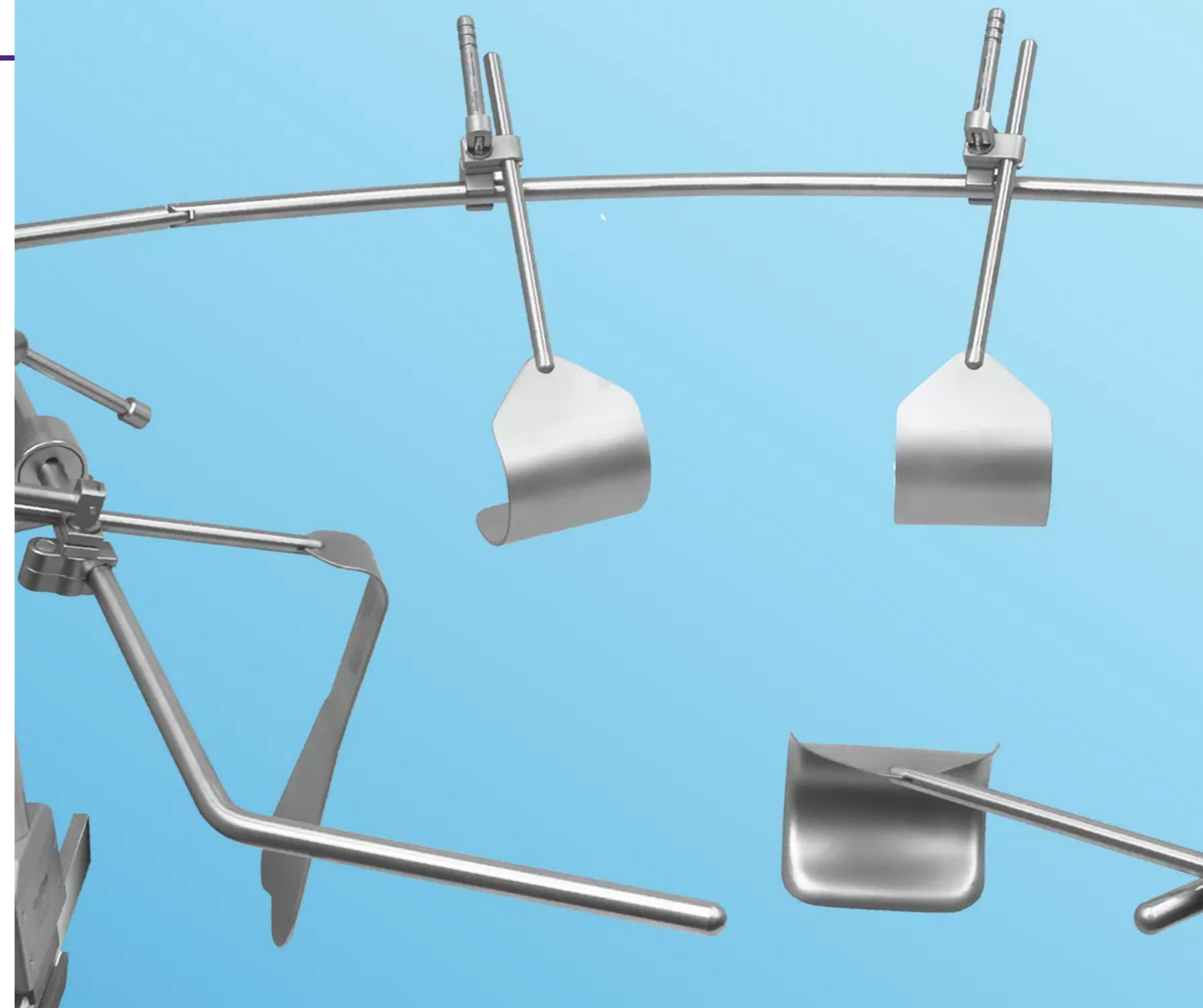

TABLE MOUNTED RETRACTOR /HANDS FREE RETRACTOR

THOMPSON TABLE MODEL RETRACTOR



ELITE II RAIL CLAMP

- Top Control eases attachment to the OR table over steril drapes.
- Cam joints lock the cross bar in place with a quick flip of the handle.
- Available with one or two cam joints.

Elite Rail Clamp w/2 Cam Joint 18" - **RCB 01.18**
 Bilateral Cross Bar - **RCB 02.18**

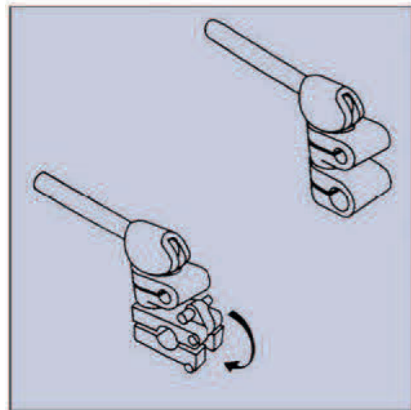

CAM UNIVERSAL JOINTS

Make set - up quick and easy

Cam Joint 1/2" x 1/2" - **RAA 03.14**
 Cam Joint 1/2" x 1/4" - **RAA 03.15**



BILATERAL CROSS BAR - HINGED

- Bilateral rigidity offers exceptional strength for costal margin elevation.
- Folding arm fits into standard sterilizing case.

RCB 10.00

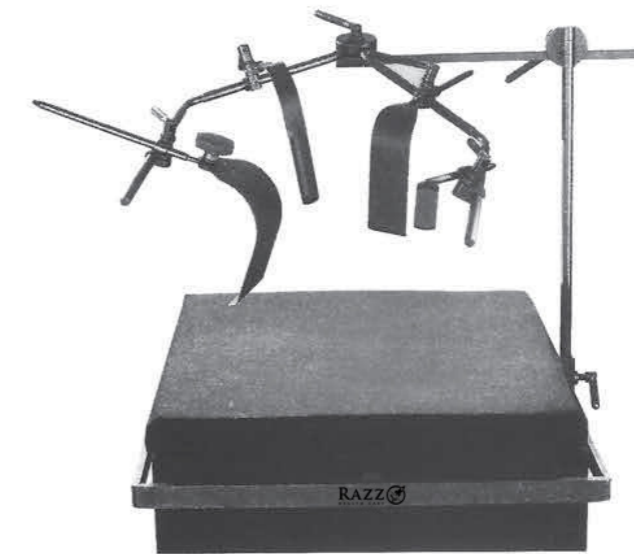

RAA 03.00



RAA 03.10



RAA 03.11



RAA 03.12

Abdominal Vascular Retractor
RAA 03.00

SET COMPONENTS

SET COMPONENTS	SET QUANTITY
RAA 03.10 Table Clamps	1
RAA 03.11 Table Upright, 20" (cm) with attached Disc Clamp	1
RAA 03.12 Crossbar with attached Disc Clamps	1
RAA 03.13 Wishbone - Split, left and right	1



RAA 03.13

TABLE MODEL RETRACTOR



RAA 03.14

RAA 03.15



RMR 03.16

RMR 03.17



RMR 03.18

RMR 03.19



RMR 03.20

RMR 03.23



RAA 03.21

RAA 03.22



RMR 03.24

RMR 03.25

ABDOMINAL VASCULAR RETRACTOR

SET COMPONENTS SET QUANTITY

RAA 03.14 Closed Universal Clamp 6

RAA 03.15 Open Universal Clamp 2

RMR 03.16 Splanchnic Retractor
2" (5cm) x 4 1/2" (11.4cm) 1

RMR 03.17 Splanchnic Retractor
2" (5cm) x 6" (15.2cm) 1

RMR 03.18 Renal Vein Retractor
1" (2.5cm) x 7" (18cm) 2

RMR 03.19 Mayo Retractor, Standard
2 5/8" (6.7cm) x 2 1/4" (5.7cm) 2

RMR 03.20A Richardson Retractor, Swivel
1" (2.5cm) x 1 3/4" (4.4cm) 1

RAA 03.21 Blade Holder, Swivel,
Handle 6" (15.2cm) 2

RAA 03.22 Blade Holder, Swivel,
with knob 9" (22.8cm) 1

RMR 03.23 Fence Blade, Swivel,
4" (10.1cm) x 6" (15.2cm) 1

RMR 03.24 Mayo Blade, Swivel,
2 5/8" (6.7cm) x 2 1/4" (5.7cm) 1

RMR 03.25 Mayo Blade, Swivel,
3 1/2" (8.9cm) x 2 3/4" (7cm) 1

RMR 03.26 Deaver Blade, Swivel,
2 3/4" (7cm) x 5" (12.7cm) 1

TABLE MODEL RETRACTOR



RAA 03.10

RAA 03.12

RAA 03.12A

RAA 03.13



RAA 03.14

RAA 03.15

RMR 03.16

RMR 03.17

RMR 03.20

RMR 03.18



RAA 03.21

RAA 03.22

RMR 03.23

RMR 03.19



RMR 03.24



RMR 03.24



RMR 03.25

ABDOMINAL VASCULAR RETRACTOR
CROSS BAR WITH ADJUSTABLE DISC CLAMP

SET COMPONENTS SET QUANTITY

RAA 03.10 Table Clamp 1

RAA 03.12 Table Upright, 20" with
attached Disc Clamp 2

RAA 03.12A Crossbar with attached
Adjustable Disc Clamp - Allow 4 positions 1

RAA 03.13 Wishbone - Split, left and right 1

RAA 03.14 Closed Universal Clamp 6

RAA 03.15 Open Universal Clamp 2

RMR 03.16 Splanchnic Retractor
2" (5cm) x 4 1/2" (11.4cm) 1

RMR 03.17 Splanchnic Retractor
2" (5cm) x 6" (15.2cm) 1

RMR 03.18 Splanchnic Retractor
2" (5cm) x 6" (15.2cm) 1

RMR 03.20 Renal Vein Retractor
1" (2.5cm) x 6" (15.2cm) 2

RMR 03.19 Mayo Retractor, Standard
2 5/8" (6.7cm) x 2 1/4" (5.7cm) 2

RMR 03.20 Richardson Retractor, Swivel
1" (2.5cm) x 1 3/4" (4.4cm) 1

RAA 03.21 Blade Holder, Swivel,
with Handle 6" (15.2cm) 2

RAA 03.22 Blade Holder, Swivel,
with Handle knob 9" (22.8cm) 1

RMR 03.23 Fence Blade, Swivel
4" (10.1cm) x 6" (15.2cm) 1

RMR 03.24 Mayo Blade, Swivel
2 3/4" (7cm) x 2" (5cm) 1

RMR 03.25 Mayo Blade, Swivel
3 1/2" (8.9cm) x 2 3/4" (7cm) 1

RMR 03.26 Deaver Blade, Swivel
2 3/4" (7cm) x 4 1/2" (11.4cm) 1

RETRACTOR ACCESSORIES

RETRACTOR BLADES DEAVER'S

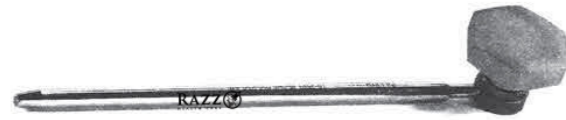

Blade Holder Swivel

RAA 03.21 Swivel 6" (15.2cm) with Handle

RAA 03.22 Swivel 9" (22.8cm) with Knob



Closed Universal Clamp

RAA 03.14 Closed Universal Clamp



RAA 03.12 Cross Bar with Adjustable Clamp



RAA 03.12 Cross Bar with Adjustable Clamp



Deaver Blade

RMR 03.26 Swivel 2 3/4" (7cm) x 5" (12.7cm)



RMR 04.01

3" (7.6cm) x 4" (10cm)



RMR 04.02

4" (10cm) x 5 1/2" (14cm)



RMR 04.03

2 3/4" (7cm) x 4 1/2" (11.4cm)



RMR 04.04

2" (5cm) x 5" (12.7cm)



RMR 04.05

1 1/2" (3.8cm) x 6" (15.2cm)



RMR 04.06

1" (2.5cm) x 5" (12.7cm)

RETRACTOR ACCESSORIES

RETRACTOR ACCESSORIES



Doherty - GML Blade
RMR 04.10
 4 ¼" (10.8cm) x 3" (7.6cm)



Fence Blade
RMR 03.23A
 Swivel 6" (15.2cm) x 5" (12.7cm)

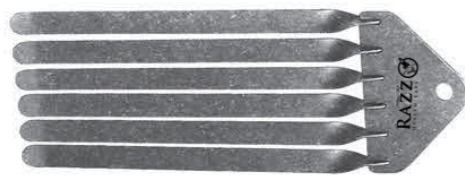

Finger Fence Blade
RMR 04.12
 Swivel, Malleable, 6" (15.2cm)



Hoe Retractor
RMR 04.13
 2" (5cm) x 1" (2.5cm)



Hoe Retractor
RMR 04.14
 2" (5cm) x 1 ½" (3.8cm)



Hoe Retractor
RMR 04.15
 2" (5cm) x 2" (5cm)



Kelly Blade
RMR 04.16
 Swivel 1 ½" (3.8cm) x 2" (5cm)



Kelly Blade
RMR 04.17
 Swivel 2" (5cm) x 2 ½" (6.3cm)



Kelly Blade
RMR 04.18
 Swivel 3" (7.6cm) x 3 ½" (8.9cm)



Kelly Blade
RMR 04.19
 Swivel 3" (7.6cm) x 4 ½" (11.4cm)



Kelly Blade
RMR 04.20
 3 ½" (8.9cm) x 4" (10cm)

RETRACTOR ACCESSORIES

RETRACTOR ACCESSORIES



Kelly Retractor
RMR 04.21
1 ½" (3.8cm) x 2" (5cm) x
9 ¾"(24.8cm)



Kelly Retractor
RMR 04.22
2" (5cm) x 2 ½" (6.3cm) x
9 ¾"(24.8cm)



Kelly Retractor
RMR 04.23
2 ½" (6.3cm) x 3" (7.6cm) x
9 ¾"(24.8cm)



Malleable Blade
RMR 04.30
Swivel 2" (5cm) x 6 ½" (16.5cm)



Malleable Blade
RMR 04.32
Swivel 3" (7.6cm) x 6 ½" (16.5cm)



Mayo Blade
RMR 03.28
Swivel 2 ¾" (7cm) x 2 ¼" (5.7cm)



Mayo Blade
RMR 03.25A
Swivel, wide 3 ½" (8.9cm) x 4" (10cm)



Mayo Blade
RMR 03.29
Swivel, wide 3 ½" (8.9cm) x 2 ¾" (7cm)



Kelly Retractor
RMR 04.24
3" (7.6cm) x 4 ½" (11.4cm) x
9 ¾"(24.8cm)



Kelly Retractor
3 ½" x 4"
RMR 04.25



Lechner - Harrington Liver Blade
5" (12.7cm) x 3 ½"(8.9cm)
RMR 04.26



Mayo Retractor Standard
RMR 03.27
2 5/8" (6.7cm) x 2 ¼" (5.7cm)



Mayo Retractor Wide
RMR 03.27A
3 ½" (8.9cm) x 2 ¾" (7cm)

RETRACTOR ACCESSORIES

TABLE MOUNT RETRACTOR SET



Open Universal Clamp
RAA 03.14



Table Clamp
RAA 03.10
Fits Over Drapes, and Accepts 1/2" (1.3 cm) and
(5/8" (1.6cm) Rods, and Also 1" 2.5cm) and 1 1/4"
(3.2cm) Rectangular Bars



Renal Vein Blade
RMR 04.33 - Swivel 1" (2.5cm) x 4 1/2" (11.4cm)



Renal Vein Blade
RMR 04.34 - Swivel 1" (2.5cm) x 6" (15.2cm)

Obesity Blade Kit RCB 10.01

Obesity Blade Kit Consisting of :

- | | |
|---|--------------|
| (1No) Elite Rail Clamp w/2 Cam Joint 18" | - RCB 01.18 |
| (1No) Bilateral Cross Bar | - RCB 02.18 |
| (1No) 24" Angled Arm - 8" x 16" | - RAA 10.02 |
| (6No) Cam Joint 1/2" x 1/2" | - RAA 03.14 |
| (2No) Cam Joint 1/2" x 1/4" | - RAA 03.15 |
| | |
| (1No) Interchangeable Renal Vein 1" x 7 1/2" | - RMR 05.35 |
| (1No) Interchangeable Malleable 2" x 10" | - RMR 05.36 |
| (1No) Interchangeable Malleable 3" x 10" | - RMR 05.37 |
| (1No) Interchangeable Malleable 4" x 10" | - RMR 05.38 |
| (1No) Interchangeable Kelly 3" x 3 1/2" | - RMR 04.19A |
| (1No) Interchangeable Fence 4" x 8" | - RMR 05.39 |
| (1No) Interchangeable Balfour 3 1/4" x 2 3/4" | - RMR 05.40 |
| (1No) Interchangeable Richardson 2" x 7" | - RMR 05.41 |
| (1No) Interchangeable Harrington 4 1/2" x 10" | - RMR 04.26A |



Renal Vein Retractor
RMR 03.18 - 1" (2.5cm) x 7" (18cm)



Renal Vein Retractor
RMR 03.18A - 1" (2.5cm) x 4" (10cm)

Obesity Blade Kit **RCB 10.02****Obesity Blade Kit Consisting of :**

(1No) Elite Rail Clamp w/2 Cam Joint 18"	- RCB 01.18
(1No) Bilateral Cross Bar	- RCB 02.18
(6No) Cam Joint ½" x ½"	- RAA 03.14
(2 No) Cam Joint ½" x ¼"	- RAA 03.15
(1No) 18" Angled Arm - 8" x 10"	- RAA 10.01
(1No) 24° Angled Arm - 11" x 13"	- RAA 10.02
(1No) 24" Angled Arm - 8" x 16"	- RAA 10.03
(1No) Locking Interchangeable Handle	- RAA 03.21
(1No) Interchangeable Crank Handle	- RAA 03.22
(1No) Interchangeable Malleable ½" x 2 ½"	- RMR 05.45
(1No) Interchangeable Malleable ½" x 6"	- RMR 05.46
(1No) Interchangeable Malleable ½" x 8"	- RMR 05.47
(1No) Interchangeable Malleable 1" x 8"	- RMR 05.48
(1No) Interchangeable Malleable 1" x 4"	- RMR 05.49
(1No) Interchangeable Malleable 2 ½" x 10"	- RMR 05.50
(1No) Interchangeable Kelly 2 ½" x 3"	- RMR 05.51
(1No) Interchangeable Kelly 3" x 3 ½"	- RMR 05.52
(1No) Interchangeable Balfour 2 ¾" x 2 ¾"	- RMR 05.53
(1No) Interchangeable Balfour 3 ¼" x 2 ¾"	- RMR 05.55
(1No) Interchangeable Balfour 1" x 1"	- RMR 05.56
(1No) Interchangeable Malleable Finger Blade	- RMR 04.12

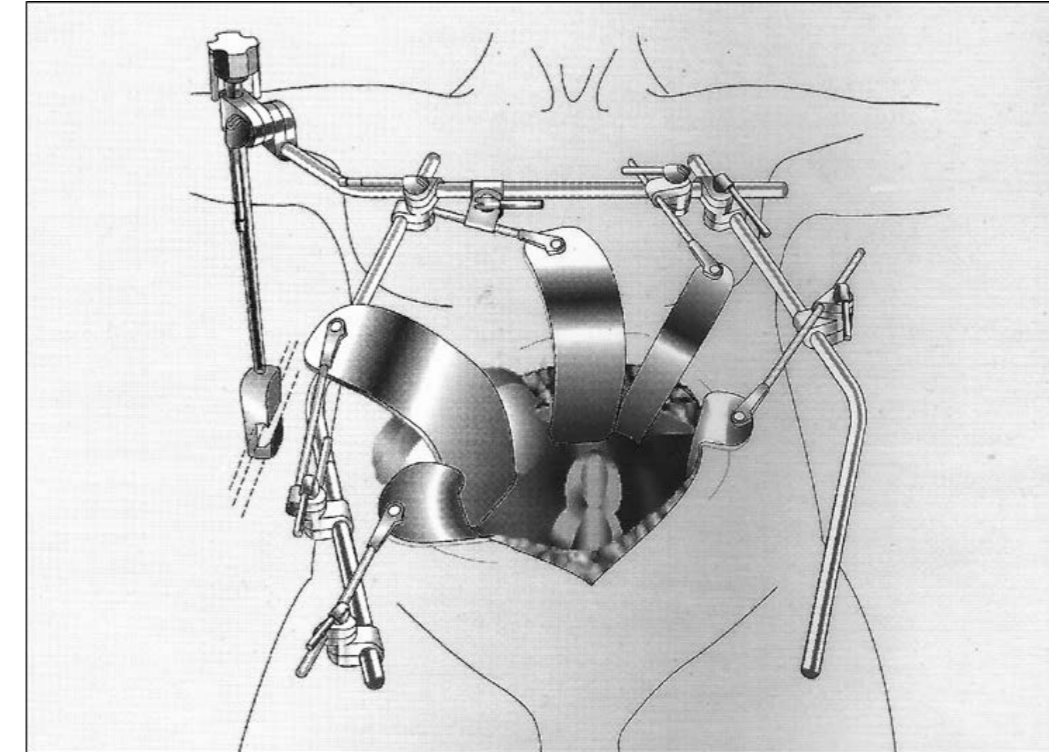
General / Vascular Retractor **RCB 10.03****General / Vascular Retractor Consisting of :**

(1No) Elite Rail Clamp w/2 Cam Joint 18"	- RCB 01.18
(1No) Bilateral Cross Bar	- RCB 02.18
(6No) Cam Joint ½" x ½"	- RAA 03.14
(2No) Cam Joint ½" x ¼"	- RAA 03.15
(1No) Interchangeable Malleable 1" x 8"	- RMR 05.48
(1No) Interchangeable Renal Vein 1" x 7 ½"	- RMR 05.35
(1No) Interchangeable Malleable 2" x 8"	- RMR 06.50A
(1No) Interchangeable Malleable 2 ½" x 10"	- RMR 05.50
(1No) Interchangeable Malleable 3" x 10"	- RMR 05.51A
(2No) Interchangeable Richardson ¾" x 1" d	- RMR 05.20A
(2No) Interchangeable Kelly 2 ½" x 3"d	- RMR 04.23
(1No) Interchangeable Fence 4" x 4"	- RMR 03.23B
(1No) Interchangeable Fence 4" x 5"	- RMR 04.23A
(1No) Interchangeable Fence 4" x 6"	- RMR 04.23C
(1No) Interchangeable Balfour 2 ¾" x 3"	- RMR 05.53
(1No) Interchangeable Balfour 3 ¼" x 2 ¾"	- RMR 05.55
(1No) Interchangeable Fenestrate 1 ¾" x 3 ½"	- RMR 03.23D
(1No) Interchangeable Richardson 2" x 5"	- RMR 04.20A
(1No) Interchangeable Harrington 2 ½" x 6"	- RMR 05.26A
(1No) Interchangeable Deaver 2" x 5"	- RMR 04.04
(1No) Interchangeable St. Mark's 2 ½" x 7"	- RMR 05.58
(1No) Interchangeable Malleable Finger Blade	- RMR 04.12

Carotid / Incision Retractor **RCB 10.04****Carotid / Incision Retractor Consisting of :**

- (1No) Elite Rail Clamp w/2 Cam Joint 18"
- (1No) Bilateral Cross Bar
- (6No) Cam Joint ½" x ½"
- (2No) Cam Joint ½" x ¼"
- (2No) Interchangeable Richardson ¾" x 1" d
- (2No) Interchangeable Richardson ¾" x 2" d
- (2No) Interchangeable Richardson 1" x 1 ¼" d
- (1No) Interchangeable Balfour 3 ¼" x 2 ¾"
- (1No) Interchangeable Volkman 17mm x 18mm

- RCB 01.18
- RCB 02.18
- RAA 03.14
- RAA 03.15
- RMR 03.20A
- RMR 03.20B
- RMR 03.20C
- RMR 05.55
- RMR 07.05

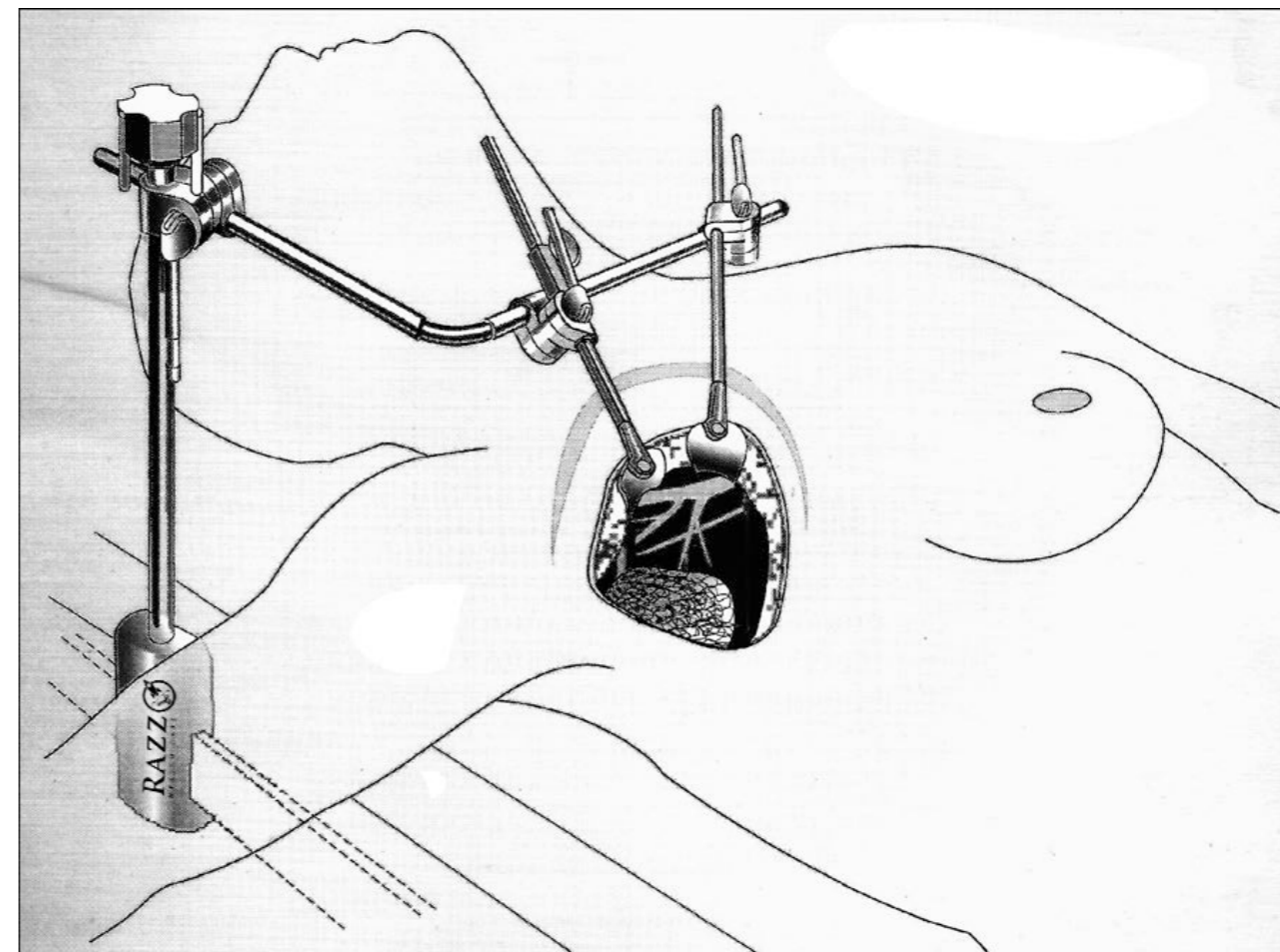
Abdominal Vascular Retractor **RCB 10.05****Abdominal Vascular Retractor Consisting of :**

- | | |
|--|-------------|
| (1No) Elite Rail Clamp w/2 Cam Joint 18" | - RCB 01.18 |
| (1No) Bilateral Cross Bar | - RCB 02.18 |
| (6No) Cam Joint ½" x ½" | - RAA 03.14 |
| (2 No) Cam Joint ½" x ¼" | - RAA 03.15 |
| (1No) Interchangeable Renal Vein 1" x 7 ½" | - RMR 07.10 |
| (1No) Interchangeable Malleable 2" x 8" | - RMR 07.12 |
| (1No) Interchangeable Malleable 3" x 10" | - RMR 07.13 |
| (1No) Interchangeable Richardson ¾" x 2" d | - RMR 07.15 |
| (1No) Interchangeable Fence 4" x 6" | - RMR 07.16 |
| (1No) Interchangeable Balfour 3 ¾" x 3" | - RMR 07.18 |
| (1No) Interchangeable Balfour 3 ¼" x 2 ¾" | - RMR 05.55 |
| (1No) Interchangeable Deaver 2" x 5" | - RMR 07.22 |

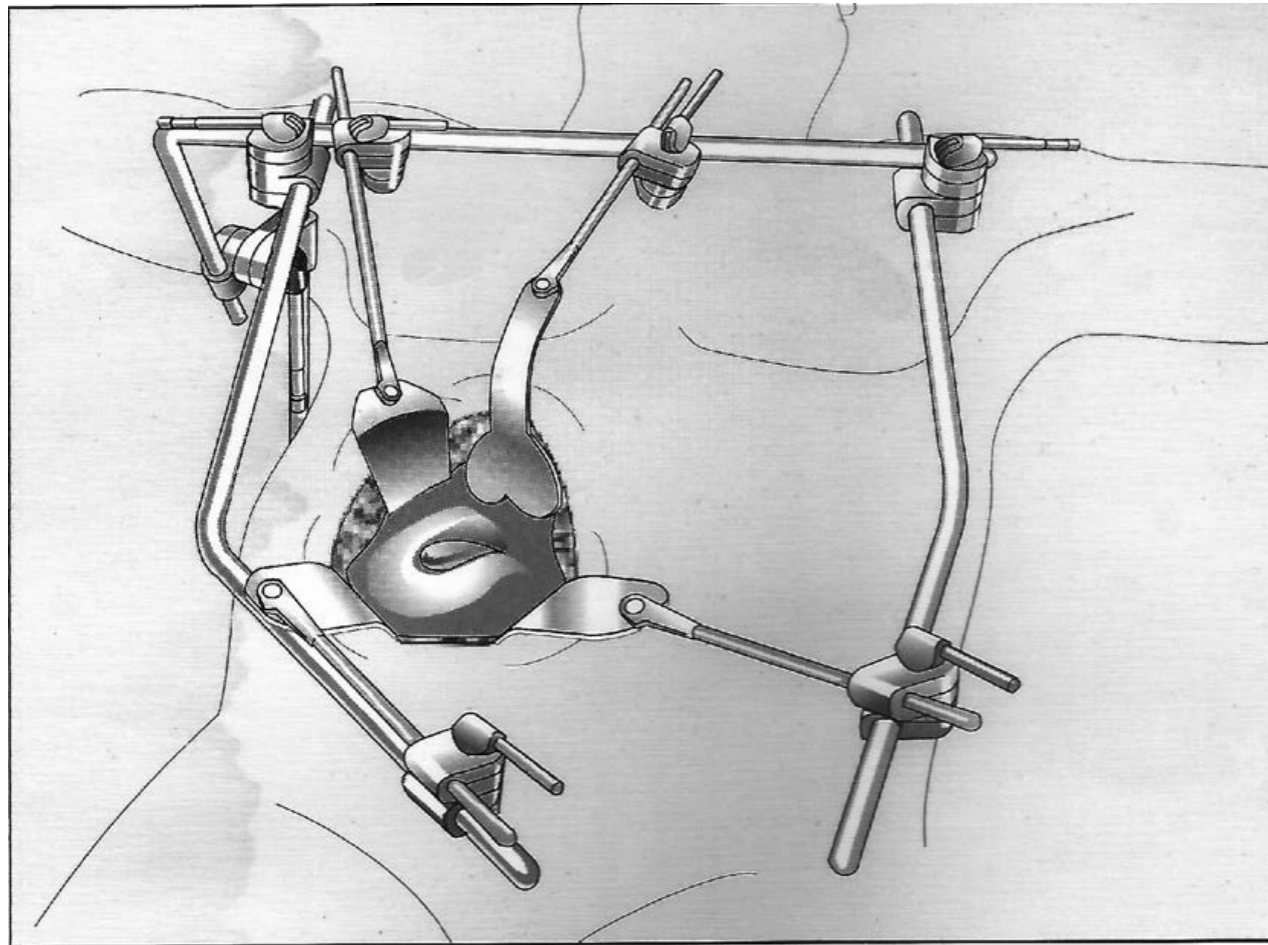

General / Retractor RCB 10.06

General / Retractor Kit Consisting of :

- (1No) Elite Rail Clamp w/2 Cam Joint 18" - RCB 01.18
- (1No) Bilateral Cross Bar - RCB 02.18
- (6No) Cam Joint 1/2" x 1/2" - RAA 03.14
- (2 No) Cam Joint 1/2" x 1/4" - RAA 03.15
- (1No) Interchangeable Malleable 2" x 8" - RMR 05.50A
- (1No) Interchangeable Malleable 2 1/2" x 10" - RMR 05.50
- (1No) Interchangeable Kelly 2 1/2" x 3" - RMR 05.51
- (1No) Interchangeable Kelly 3" x 3 1/2" - RMR 05.52
- (1No) Interchangeable Fence 4" x 6" - RMR 03.23C
- (1No) Interchangeable Balfour 2 3/4" x 3" - RMR 05.53A
- (1No) Interchangeable Richardson 2" x 5" - RMR 04.20A
- (1No) Interchangeable Harrington 2 1/2" x 6" - RMR 05.26A
- (1No) Interchangeable Deaver 2" x 5" - RMR 04.04

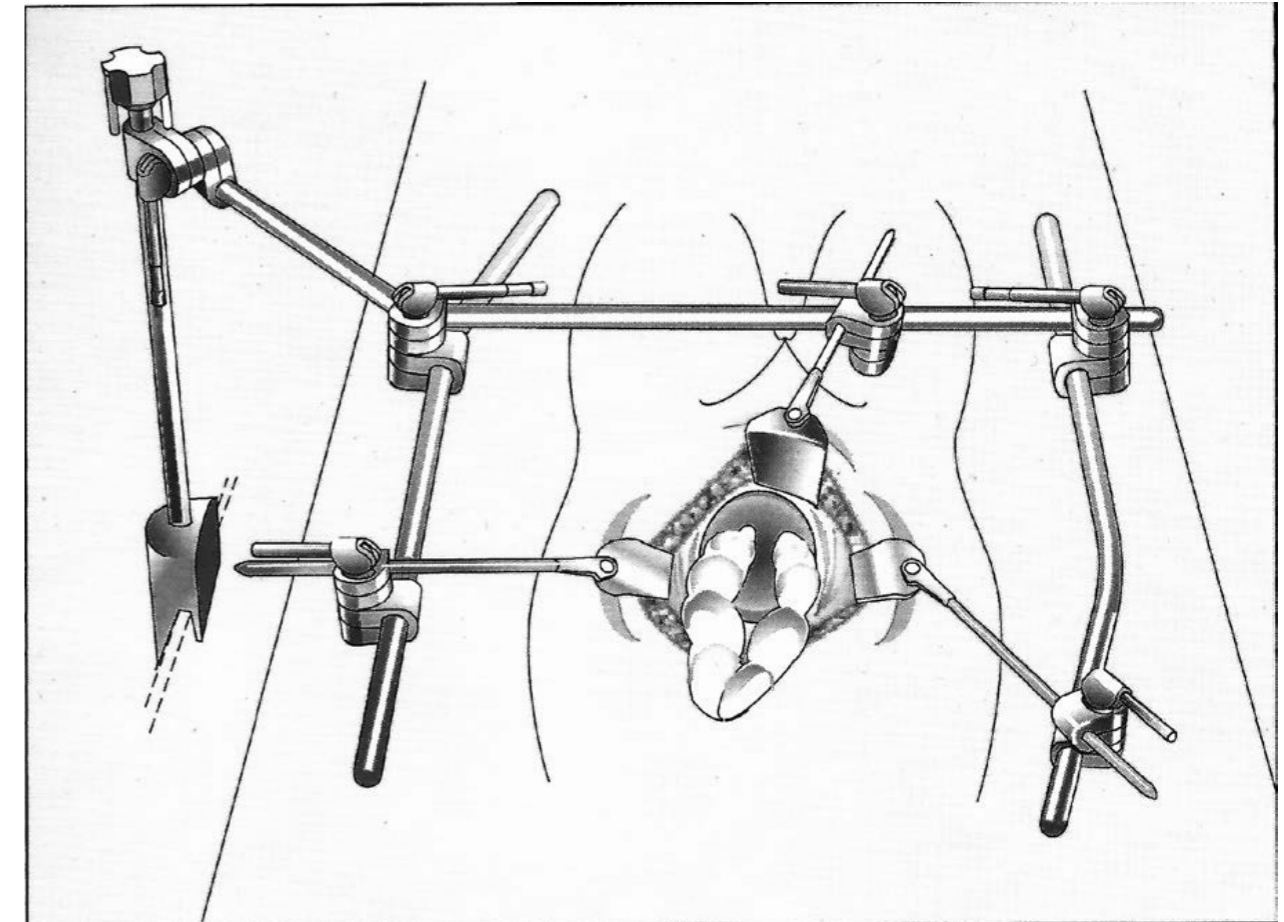

Pediatric / Retractor Kit RCB 10.07

Pediatric / Retractor Kit Consisting of :

- (1No) Elite Rail Clamp w/2 Cam Joint 18" - RCB 01.18
- (1No) Bilateral Cross Bar - RCB 02.18
- (6No) Cam Joint 1/2" x 1/2" - RAA 03.14
- (2 No) Cam Joint 1/2" x 1/4" - RAA 03.15
- (1No) Interchangeable Malleable 1/2" x 2 1/2" - RMR 05.45
- (1No) Interchangeable Malleable 1/2" x 6" - RMR 05.46
- (1No) Interchangeable Malleable 1/2" x 8" d - RMR 05.47
- (1No) Interchangeable Malleable 1" x 4" d - RMR 05.49
- (1No) Interchangeable Pedi Malleable 2" x 4" d - RMR 05.49A
- (1No) Interchangeable Richardson 3/4" x 1 3/4" d - RMR 03.20A
- (1No) Interchangeable Richardson 3/4" x 2" d - RMR 03.20B
- (1No) Interchangeable Richardson 1" x 1 1/4" - RMR 03.20C
- (1No) Interchangeable Kelly 1 1/2" x 2" d - RMR 04.16
- (1No) Interchangeable Kelly 2" x 2 1/2" d - RMR 04.17
- (1No) Interchangeable Balfour 1" x 1" - RMR 05.56
- (1No) Interchangeable Harrington 4 1/2" x 10" d - RMR 04.26A
- (1No) Interchangeable Harrington 1 1/2" x 5" d - RMR 04.26B
- (1No) Interchangeable Deaver 1" x 5" d - RMR 04.05A

TABLE MOUNT RETRACTOR SET

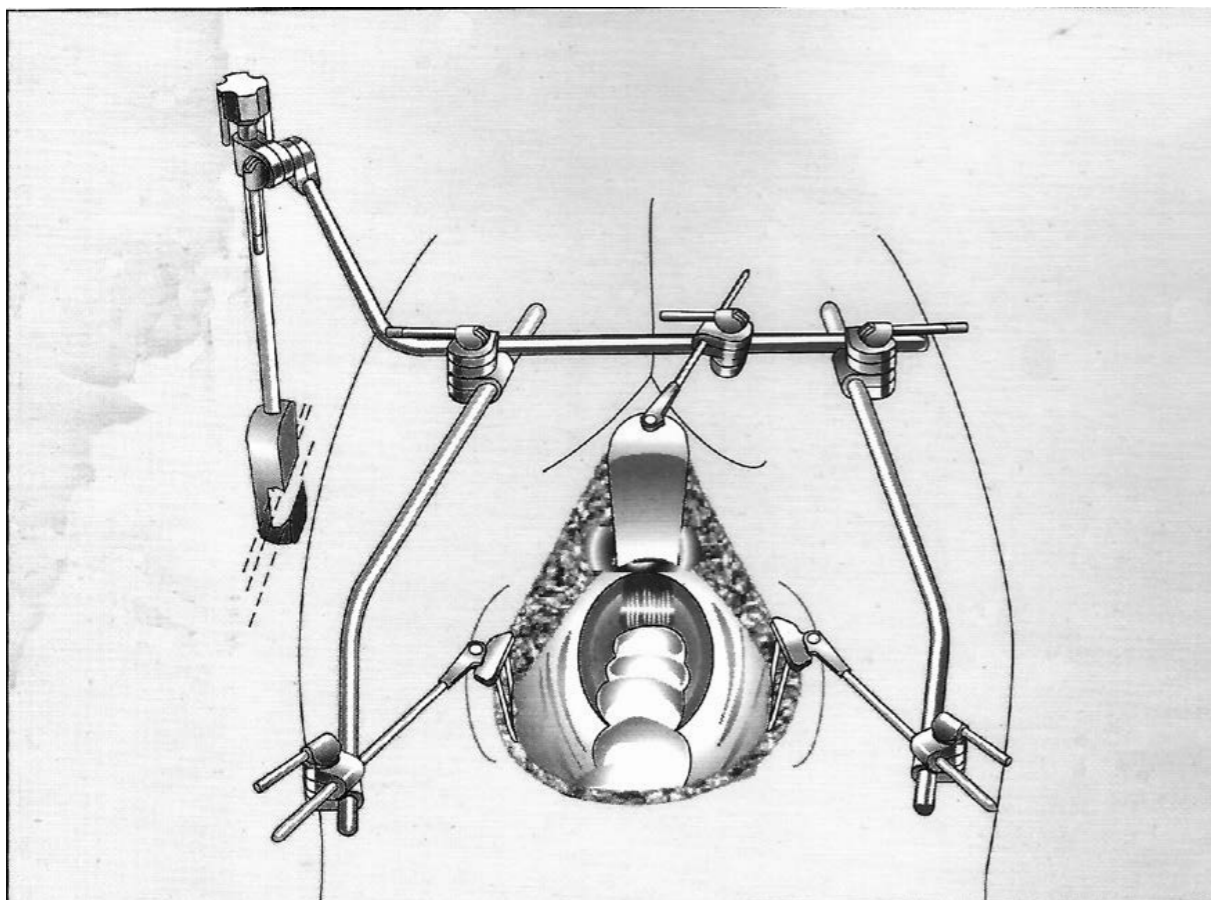
Colon / Retractor **RCB 10.08****Colon / Retractor Consisting of :**

(1No) Elite Rail Clamp w/2 Cam Joint 18"	- RCB 01.18
(1No) Bilateral Cross Bar	- RCB 02.18
(6No) Cam Joint ½" x ½"	- RAA 03.14
(2 No) Cam Joint ½" x ¼"	- RAA 03.15
(1No) Interchangeable Fenestrater 1 ¾" x ½"	- RMR 03.23E
(1No) Interchangeable Deaver 1" x 5" d	- RMR 04.06
(1No) Interchangeable St. Mark's 2 ½" x 7" w/o	- RMR 05.57
(1No) Interchangeable St. Mark's 2 ½" x 7"	- RMR 05.57A
(1No) Interchangeable St. Mark's 2 ½" x 5 ½"	- RMR 05.57B



CONTACT US

A: TS No 12/1, First Floor, Fathima Golden City, Banghi Shop, Ambur,
Tirupattur District, Tamil Nadu - 635802, India.

E: support@razzohealthcare.com

E: sales@razzohealthcare.com

W: www.razzohealthcare.com

P: +91 78710 11999, +91 78678 03388, +91 4174 299 565